



ZYGGOT THERMOGRAPHY + ARC FLASH

ONLINE THERMOGRAPHY + ULTRA SELECTIVE ARC FLASH PROTECTION SYSTEM

ZYGGOT V5FTA/O THM+ARC MONO GATEWAY ZYGGOT V5FTA/M THM+ARC MULTI GATEWAY



CONTINUOUS TEMPERATURE MONITORING + UV ARC FLASH PROTECTION SYSTEM

CATALOG

ZYGGOT THERMOGRAPHY

TEMPERATURE +ARC FLASH MONITORING SYSTEM



DESCRIPTION

Varixx was the world's first company to introduce a Continuous, Online, Networked Temperature Monitoring System in 2008 and is a market leader in this area. The low-cost ZYGGOT system was designed to allow online monitoring of the temperatures of low and medium voltage components and internal connections, transformers, motors, etc., replacing old methods of periodic thermography with cameras.

The ZYGGOT system introduced an important innovation to the market because current safety standards prohibit the opening of energized electrical panels for any type of measurement, including temperature measurements with manual point-of-care guns or thermography cameras, without the use of appropriate protective clothing.

An important feature of the ZYGGOT system is that it simultaneously measures both the target and the sensor body, which is equal to the temperature of the surrounding air.

This feature also allows the detection of an increase in the internal temperature of the panel, which can identify obstructions or ventilation failures or even an increase in the temperature of equipment not directly monitored.

Sensors with opening angles of 7° allow the monitoring of both well-defined points (points) and areas of any size, depending on the distance from the sensor to the area.

Varixx also introduced the world's first and only Ultraviolet arc detection system in 2014, which does not require confirmation of current rise and inhibits arc formation at its onset due to its extremely fast action (<250 μS), detecting the arc in its initial phase and not in the fourth phase of the arc, already formed, thereby reducing the Incident Energy by around 80 to 150 times compared to the competition. It is a system that has already been widely approved, with hundreds of real cases of detection and action, with minimal or no damage to the protected systems, with a return to operation time of minutes to a few hours.

Furthermore, as it does not require current monitoring, it is very easy to implement and costs much less than light and current detection

systems.

In addition to the independent CTM and Arc Flash systems, which continue in the product portfolio, Varixx is introducing the integrated Continuous Temperature Monitoring + Arc Flash system, which saves panel door space and facilitates integration with the user's DCS system, featuring Modbus and Ethernet communication.



Gateway

Sensor UVB



Sensor UVA



Sensor Tubular



Sensor UV Octagonal



Sensor BT



APPLICATION

On-line temperature monitoring and protection of electrical connections and components for low and medium voltage electrical panels, transformers, motors, brakes, processes, etc., and integrated protection against electric arcs (Arc Flash).

BENEFITS

- * Prevents opening of the energized panel.
- * Dispenses with periodic thermography.
- * Provides target and internal air readings.
- * Non-contact measurement.
- * Arc detection in phase 1 (pre-arc).
- * Reduction in incident energy between 80 and 150 times compared to the competition.
- * Indicates any sensor failure.
- * Failure history.
- * Modbus and Ethernet communication

System Features

- * Applicable in low and medium voltage.
- * Up to 100 non-contact temperature sensors and 100 UV arc sensors in RS485 network with mini USB connections.
- * Smart Sensors powered by the network itself.
- * Measuring angle of 7° for temperature and 90° for Arc.
- * Continuous temperature readings.
- * Relay with color graphic touch screen display and Modbus and Ethernet communication.
- * Fault history with "Time Stamp".
- * Reading and over-temperature protection of up to 100 point or area targets in addition to 100 body/air temperatures.
- * Arc Flash protection with up to 40 triggering Gateways, each with up to 100 sensors for Ultraviolet detection.
- * Readings and protections related to 4 analog inputs.
- * External fault monitoring.
- * Sensor status monitoring.
- * 4 programmable digital outputs.
- * Each sensor has a flashing LED and can be controlled by the relay to facilitate its location and address on the network.
- * Operation in «Fail Safe» mode
- * Ethernet protocols:
 - TCP/IP (Modbus Slave): Modbus over Ethernet.
 - Ethernet/IP: ODVA CIP over Ethernet.
 - FTP: (File Server) File Transfer Protocol.
 - ASCII over TCP/IP: ASCII Data over Ethernet.
 - NTP Protocol: Network Time Protocol HTTP (Web Server): Hypertext Transfer Protocol (Web Server).

MAIN ADVANTAGES

- CAN BE TESTED WITH THE SYSTEM OFF
- WITH ETHERNET
- INTEGRATES ARC PROTECTION
- WORLD'S MOST ADVANCED ARC PROTECTION
- HIGH SELECTIVITY FOR ARC (VERSION MULTI GATEWAY)
- ARC ACTUATION IN LESS THAN 250uS
- REDUCES INCIDENT ENERGY BY UP TO 150X
- DISPENSES CURRENT MEASUREMENT FOR ARC
- DOES NOT NEED CONVENTIONAL THERMOGRAPHY
- CAN MEASURE NON-VISIBLE POINTS
- MEASUREMENT WITHOUT ELECTRICAL CONTACT
- DOES NOT USE BATTERIES
- INDIRECTLY MEASURES THE ENTIRE SYSTEM (AIR)
- PROVEN RELIABILITY
- HISTORY OF EVENTS
- TEMPERATURE PLOT
- WORLD LEADING SYSTEM

The ZYGGOT system with stainless steel tubular sensors was developed for low and medium voltage panels. The THM sensors measure temperature without physical contact, by infrared detection, and allow local and online reading and protection for up to 100 targets per relay. Each sensor measures two temperature levels: the target and the air surrounding the sensor (case), allowing fault detection at unmeasured points, by indirect heating of the air. They are networked using mini USB cables, in sizes from 0.3 to 8.0 meters (supplied), which allows for quick, error-free installation without tools. The relay provides local protection and also through a supervisory system. Alarm and trip levels are freely programmable for each point. An eventual failure in one of the sensors does not interrupt the operation of the other sensors. The BT Sensor is applied in low voltage MCCs, which require a high number of sensors in a small space, in addition to demanding a low cost. Its quick-fix base can be fixed using a screw or a stainless steel strip directly to the bus to be monitored. The Arc sensors are also connected to a CAN network to a Gateway.

KEY POINTS

- Color Touch Screen.
- Has Ethernet communication with several protocols.
- Several built-in protections.
- UV arc protection, the most advanced in the world (Patent N° PI 0903809-4).
- Reduces incident energy by up to 150 times compared to light and current detection systems.
- Does not require current measurement to confirm an arc.
- Also available is a Multi Gateways version, which allows high selectivity for arc tripping, using a low-cost triggering Gateway per cubicle or per associated circuit breaker.
- Real-time graphical recording (Plot).
- History of failures and events.
- Continuous readings of target and surrounding air temperatures.
- Modbus RTU communication (and others).
- Networks of common temperature and arc sensors.
- Integrates arc protection with continuous thermography.
- Each relay presents up to 400 continuous measurements, namely: Temperature of 100 targets, Temperature of 100 sensor bodies (surrounding air), voltage of 100 temperature sensors plus 100 arc sensors (allowing monitoring of network integrity).

APPLICATIONS

- Internal panels for online thermography (continuous temperature measurement) and arc flash protection.
- Transformer monitoring.
- Substation monitoring.

MAIN FEATURES

- Reads temperature of up to 100 targets per relay. Reads temperature from up to 100 sensors (body / surrounding air), allowing detection of temperature increases at points not directly monitored.
- Reads supply voltage from up to 200 sensors (T+A).
- Up to 100 arc sensors per relay.
- Monitors Arc Flash by UV detection.
- Dispenses with current measurement for arc confirmation.
- Actuation in less than 250uS, in the pre-arc phase, reduces incident energy by up to 150x in relation to systems by light and current detection.
- Also available is a Multi Gateways version that allows high selectivity for arcing, allowing each circuit breaker to be tripped independently of the others, using a low-cost gateway per cubicle and a single relay per system.
- Configurable alarm and trip levels for temperature.
- Real-time graphic record for temperatures.
- Detection of differential temperature increases integrated into the relay and configurable by the user.
- Fault and status history.
- Continuous readings.
- 4 analog inputs with configurable alarm and trip levels.
- 8 digital inputs for external events or faults (ventilation, doors, etc.).
- Modbus RTU + Ethernet.



TECHNOLOGY AND MAIN FEATURES OF THE ARC SYSTEM

The ZYGGOT Arc Flash Protection System, integrated in this product with the Zyggot V5FTA THM+ARC Temperature Monitoring Relay, was designed to allow full-time monitoring and protection against arc flash of low and medium voltage electrical equipment such as panels, transformers, motors and generators.

The ZYGGOT Arc Flash Protection System introduces an important innovation to the market due to the fact that it detects ultraviolet (UV) radiation from the beginning of the arc, that is, from the pilot path, in phase 1 of the arc, before the detection of light from other systems. The light phase is already the final phase of the arc, with expansion of gases and vaporization of copper and other metals. Another important advantage is that selective monitoring of ultraviolet radiation eliminates the need for simultaneous monitoring of the current to confirm the occurrence of the arc, which is required by visible light detection systems.

If ultraviolet radiation is emitted at certain levels, the system can be safely tripped. Systems that detect visible light could be activated by door openings or light entering through cracks, which requires simultaneous current monitoring to avoid undue tripping.

The ZYGGOT Arc Flash Protection System, unlike light detection systems, can be applied even under direct sunlight*, thus opening up the possibility of using it in external systems (outdoor substations, transformers, motors, etc.).

The sensors have a 90° opening angle that allows monitoring large areas and practically an entire cubicle with a single sensor, since it even detects UV reflected on the internal walls of the panel, thus detecting the start of arcs in areas not directly targeted.

The effective monitoring distances are high due to the high sensitivity of the sensors. Each arc sensor, up to 100 per relay, is connected to a high-speed CAN network and this network is connected to a triggering Gateway, which is responsible for providing the trip signal at 300 µs, regardless of the speed of the Zyggot relay on the panel port. A single gateway and Zyggot relay can monitor up to 100 arc sensors per UV (plus 100 temperature sensors in the case of this system).

The interconnection of the sensors to the detection and triggering gateway uses a high-speed CAN network with clean and efficient wiring, unlike star systems, with analog or non-analog signals, which require each sensor to be independently connected to concentrator or interface modules. The high speed of detecting the occurrence of an electric arc and sending the trip signal (300 µs) ensures safety, because in the event of an electric arc, the sooner the energy is removed from the system, the less damage will be caused by the incident energy (up to 105 times less than systems with visible light).

Even when using circuit breakers with an opening time of tens of milliseconds, the system is guaranteed to trip, even if the network interconnection cable were destroyed by the arc, because before the destruction, the signal would have already reached the relay and the circuit breaker (in dozens of real protection cases that occurred over many years of use, no system was damaged, due to the high speed of operation, inhibiting the arc and not mitigating it). Another important difference is that the transmitted signals are digital, already processed in the microprocessor sensor and transmitted by shielded cables, therefore being immune to extremely strong electromagnetic fields generated by the arc current, unlike what can occur with visible light detection systems, with photocells, which transmit an analog signal to the interface.

FASES DO ARCO



BENEFITS

- * Monitors ultraviolet radiation in bands A and B.
- * Detects phase 1 of the arc, before the visible light phase (i.e. expansion and destruction).
- * Dispenses with simultaneous current monitoring to configure the occurrence of an arc.
- * Sends the trip signal in less than 300 µs.
- * A single Gateway + intelligent ZYGGOT relay with latest-generation ARM CORTEX microprocessors monitors up to 100 arc sensors per gateway (+100 temperature sensors per Zyggot relay).
- * Reduction of up to 150 times in incident energy.
- * Low implementation cost.
- * High reliability.
- * Allows for high selectivity, if necessary (Multi Gateways Version).
- * "Open" system, does not depend on proprietary software, and can be interconnected to the DCS.

PHASES OF THE ARC

Pre-Arc: Ionization of the air and formation of the path for the occurrence of an electric arc. In this phase, ultraviolet light is released (0 to 1 ms). This is the phase in which the arc sensor operates.

Compression: The energy of the arc is discharged into the air contained in the room, with a consequent increase in pressure (5 to 15 ms).

Expansion: The increase in pressure caused by the previous stage activates the relief mechanism and the air begins to be expelled to the outside, reducing the internal pressure (15 to 40 ms).

Expulsion: The pressure inside the room decreases, but the hot air continues to be expelled at an approximately constant pressure. The temperature potentially increases. The expulsion of air tends to be extinguished when the room's environment reaches the temperature of the arc (40 to 60 ms);

Thermal: The arc completely affects the insulating materials. The temperature reaches thousands of degrees Celsius and the conductive and structural materials begin to melt. This phase continues until energy dissipation occurs.

MAIN SYSTEM FEATURES

- > Intelligent trigger gateway and relay (with ARM CORTEX microprocessors). Up to 100 gateways can be connected per relay.
- > Applicable in low and medium voltage.
- > High-speed CAN network for sensors.
- > Relay with Modbus RTU port for connection to PLCs.
- > Intelligent arc sensors powered by the CAN network itself.
- > 90° measuring angle.
- > Voltage and sensor status monitoring.
- > Does not require analog interfaces.
- > Gateway, sensors and relays can be configured and tested by PC with free software.
- > Allows high selectivity for tripping, using a low-cost triggering Gateway per cubicle/circuit breaker and a single Zyggot relay per system, or even dispensing with the relay (Multi Gateways Version).
- > Possibility of using only the Gateway, without the Zyggot relay, since the Gateway has Modbus communication and can be connected directly to the user's DCS system.
- > Up to 100 sensors connected to a single Gateway + Zyggot Relay. (Network with plug-in sensors).
- > Each sensor has an LED that flashes when commanded by the relay, to detect faults or their identification.
- > Trigger gateway with 3 digital outputs, one TRIP (solid state and mechanical) and two programmable.
- > Zyggot relay with 4 or 12 programmable digital outputs and 4 digital inputs for external faults, etc., in addition to 4 analog inputs.
- > Easy testing with ArcSafe hand-held tester (arc generator)

EXAMPLE OF A TYPICAL APPLICATION USING MULTIPLE GATEWAYS AND A SINGLE RELAY

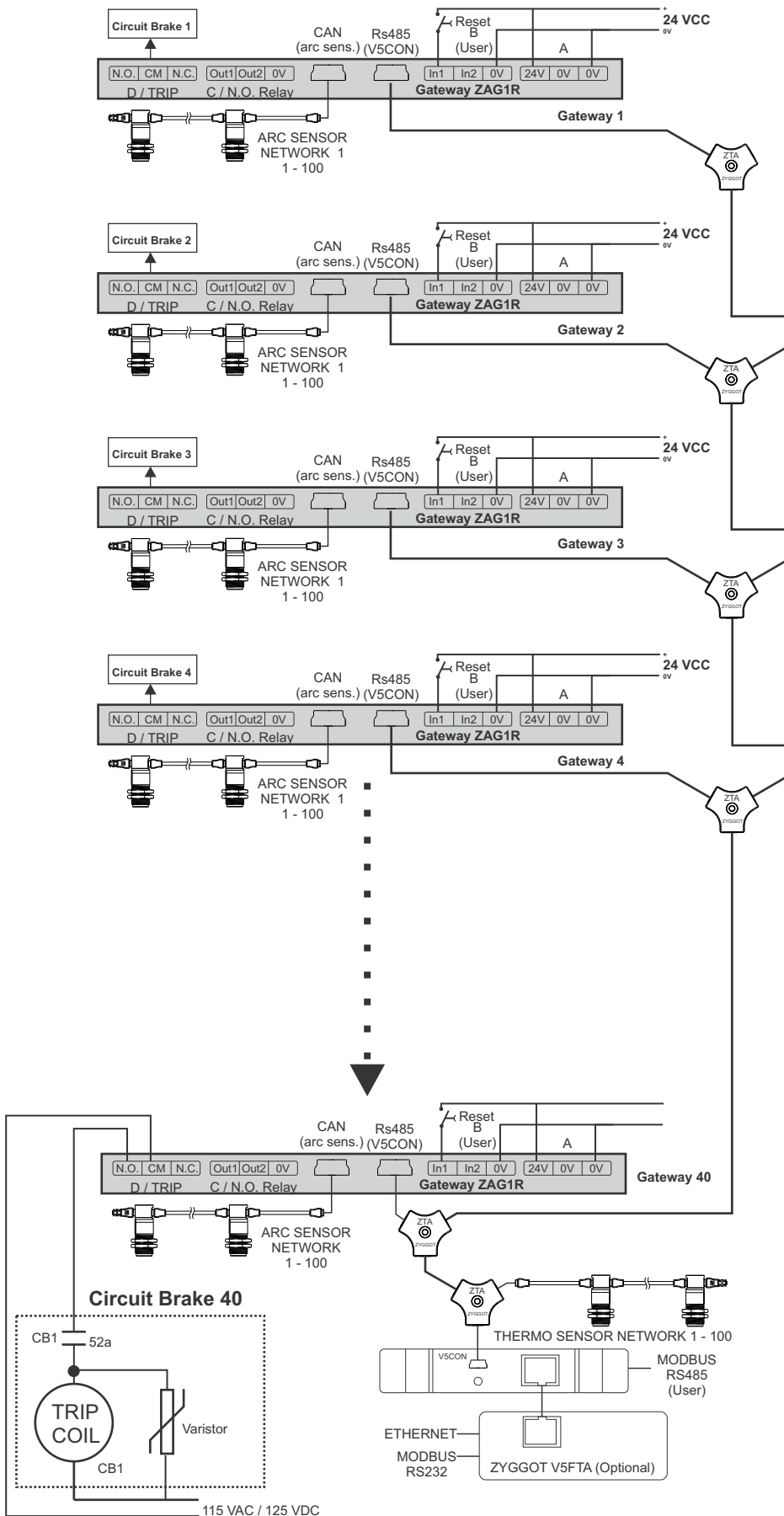

NOTE: The Polarity of the 125VDC does not matter.

In cases where high selectivity is required, such as in cases of distribution branches with one circuit breaker per branch, the side topology can be used with multiple triggering Gateways, each one triggering its own associated circuit breaker and using the relay to page information from up to 40 Gateways, each with up to 100 arc sensors, i.e. configuring a low-cost, high-efficiency system.

Even if several Gateways are associated with a single Zyggot relay, this relay can still monitor up to 100 target temperatures and up to 100 surrounding air temperatures, since the continuous temperature monitoring system is predictive, not requiring a "TRIP" but rather an "Alarm", unlike the ARC protection system where each Gateway sends the "TRIP" signal to its circuit breaker in less than 300 μ s.

TYPICAL CONNECTIONS (THM ONLY)

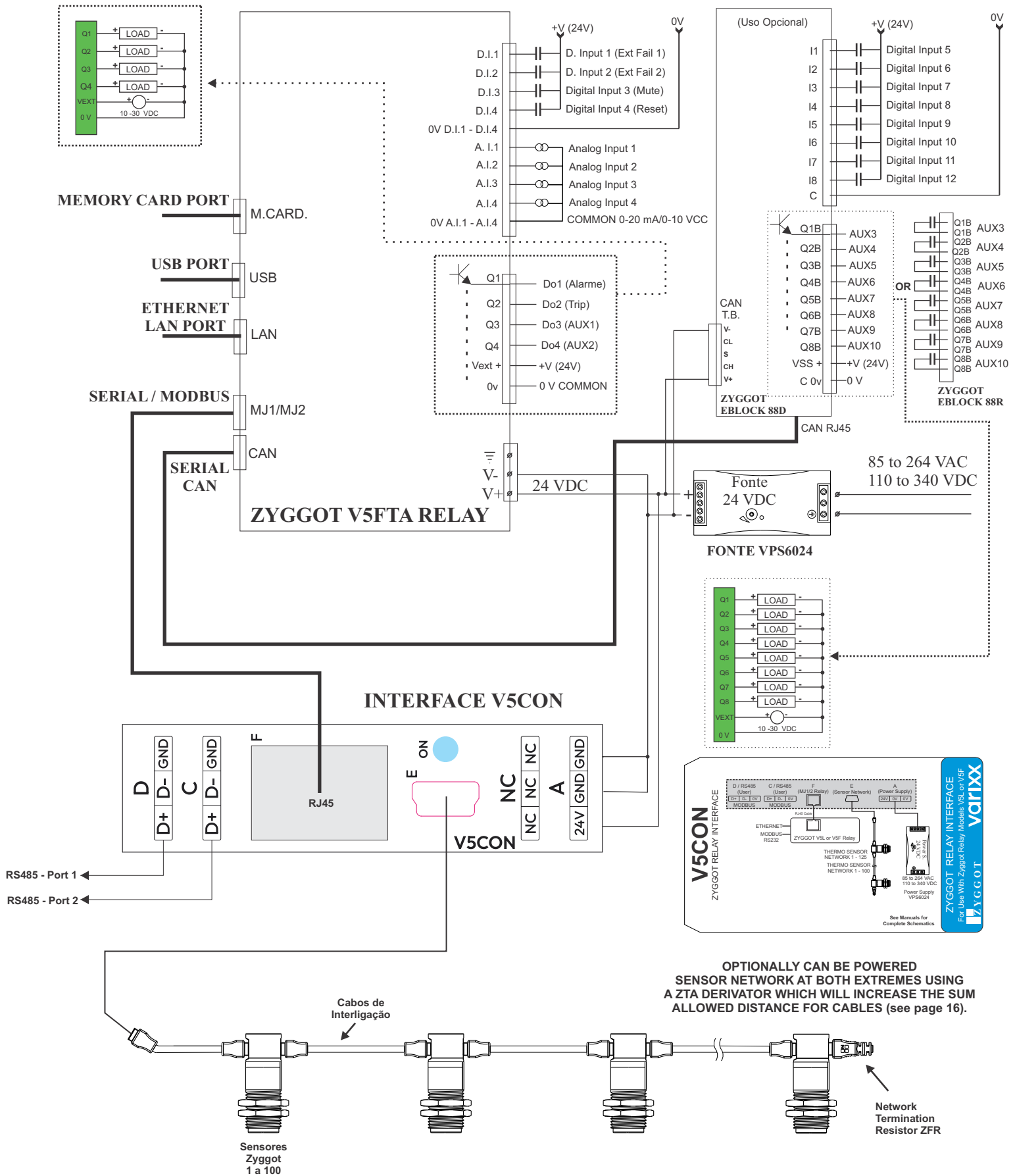

HUNDREDS OF ACCESSIBLE SCREENS



1. MAIN SCREEN	8. TARGET ALARM	16. ARC FLASH
2. TARGET	9. TARGET TRIP	17. ARC SEQUENC.
3. AIR	10. AIR ALARM	18. ARC STATUS
4. SELECTED	11. AIR TRIP	ALARM
5. FAILS	12. THM STATUS	HISTORY
6. TRENDSING	14. DIFFERENT.	MENU
7. IDENTITY	15. REPORT	ESC

varixx >>

ZYGGOT THERMO / FLASH ARC VERS:##.## F

THM S. COMM OK S. COMM ERROR HH:mm:ss

ARC S. COMM OK S. COMM ERROR dd-mm-yyyy

THM S. COMM ERR GATEWAY ALARM TTTTTTTT

LINK ETHERN. OK GATEWAY TRIP TTTTTTTT

ETHERN. LINKED GATEWAY COMM TTTTTTTT

FAIL TRGT AIR THR ARC ANR 1 ALARM TRIP

FAIL SAFE SYSTEM >>

FAIL SAFE MODE WITH AUTOLOAD ENABLED, AUTOFLASH ENABLED AND FLASH BACKUP DONE.

ONLY SAVE BACKUP TO FLASH AFTER ALL PARAMETERS ARE PROGRAMMED AND FINISHED TO CHANGE SETTINGS GO TO PROGRAM MENU.

READY CARD STATUS: TTTTTTTTTTTTTTTTTT

AUTOLOAD ENABLED AUTOFASH ENABLED

FLASH BACKUP DONE FLASH BACKUP CLEAR

AUTO RESTORE DONE AUTO LOAD FAIL

REMOVE / INSERT CARD SAFELY >>

READY CARD STATUS: TTTTTTTTTTTTTTTTTT

WAIT NO CARD CARD OK

REMOVE / INSERT? TTT

READY TO REMOVE/INSERT

MUTE ALARM >>

RESET FAIL ESC

FAIL ACTIVE ALRM UNACK ALRM UNCLEAR

FAIL TRGT AIR THR ARC ANR 3 ALARM TRIP

READING ARC GATE MS3 >>

NEW SCAN: 0

READING ARC SENSOR 100

READING SENSOR: ### ESC

TIME TO AUTO SAVE DATA: ###:##:## S

FAIL TRGT AIR THR ARC ANR 2 ALARM TRIP

READING THERMO MS2 >>

NEW SCAN: 0

READING THERMO SENSOR 123

READING SENSOR: ### ESC

TIME TO AUTO SAVE DATA: ###:##:## S

FAIL TRGT AIR THR ARC ANR 2 ALARM TRIP

THERMO SENSOR COMMUNICATION MS9 >>

SENSOR COMM OK S. COMM ERROR

TIMEOUT FRAME/PARITY

RESP. FORM. CRC/CHECKSUM

REJEC. ADDR REJEC. COMM

FAIL TRGT AIR THR ARC ANR 9 ALARM TRIP

DIGITAL I/O eBLK / ARC GWY MS7 >>

D. INP. EB1: ALM 1 D. OUT. EB1: ALM 1

D. INP. EB2: ALM 2 D. OUT. EB2: ALM 2

D. INP. EB3: ALM 3 D. OUT. EB3: ALM 3

D. INP. EB4: ALM 4 D. OUT. EB4: ALM 4

D. INP. EB5: ALM 5 D. OUT. EB5: ALM 5

D. INP. EB6: ALM 6 D. OUT. EB6: ALM 6

D. INP. EB7: ALM 7 D. OUT. EB7: ALM 7

D. INP. EB8: ALM 8 D. OUT. EB8: ALM 8

D. INP. GATEWAY 1 D. OUT. GATEWAY 1

D. INP. GATEWAY 2 D. OUT. GATEWAY 2

D. OUT. GWY TRIP

FAIL TRGT AIR THR ARC ANR 7 ALARM TRIP

ARC SENSOR COMMUNICATION MS10 >>

SENSOR COMM OK S. COMM ERROR

TIMEOUT FRAME/PARITY

RESP. FORM. CRC/CHECKSUM

REJEC. ADDR REJEC. COMM

FAIL TRGT AIR THR ARC ANR 10 ALARM TRIP

ETHERNET COMMUNICATION MS12 >>

LINKED NOT LINKED

HALF DUPLEX FULL DUPLEX

SPEED 10 Mbps SPEED 100 Mbps

TX RX

FAIL TRGT AIR THR ARC ANR 12 ALARM TRIP

ACTIVE FAILS MS13 >>

TARGET ALARM AIR ALARM

TARGET TRIP AIR TRIP

DIFF ALARM ARC FLASH

THM COMM. FAIL GWY COMM. FAIL

MODBUS FAIL ARC S. NOT RESP

THM S. NOT RESP ARC CHAIN

DIFFERENTIAL GWY NOT PROG.

FAIL TRGT AIR THR ARC ANR 13 ALARM TRIP

MANUAL SAVE DATA MS15 >>

SAVE TARGET TEMPERATURES

SAVE AIR TEMPERATURES

BACKUP STATUS: TTTTTTTTTTTTTTTTTT

MEMORY CARD STATUS: TTTTTTTTTTTTTTTTTT

FAIL TRGT AIR THR ARC ANR 15 ALARM TRIP

TARGET T01 >>

T001: #### T004: ####

T002: #### T005: ####

T003: #### T006: ####

AIR A01 >>

A001: #### A004: ####

A002: #### A005: ####

A003: #### A006: ####

FAILS MUTE ALARM RESET FAIL AF1 >>

TARGET TRIP

TARGET ALARM

AIR TRIP

AIR ALARM

THM COMM. FAIL

THM SENSOR NOT RESP.

ALARM STATE ACTIVE TRIP STATE OUTPUT

FAIL ACTIVE ALRM UNACK ALRM UNCLEAR

FAILS MUTE ALARM RESET FAIL AF8 >>

GATEWAY NOT PROGRAMMED

ARC GATEWAY COMM FAIL

ARC SENSOR NOT RESP.

ARC FLASH ALARM

ARC FLASH TRIP

ARC CHAIN

ALARM STATE ACTIVE TRIP STATE OUTPUT

FAIL ACTIVE ALRM UNACK ALRM UNCLEAR

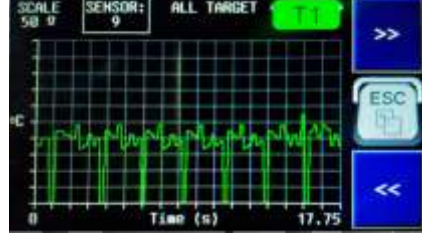

TARGET ALARM TA1 >>

T 001 T 006 T 011

T 002 T 007 T 012

T 003 T 008 T 013

T 004 T 009 T 014

T 005 T 010 T 015

AIR ALARM AA1 >>

A 001 A 006 A 011

A 002 A 007 A 012

A 003 A 008 A 013

A 004 A 009 A 014

A 005 A 010 A 015

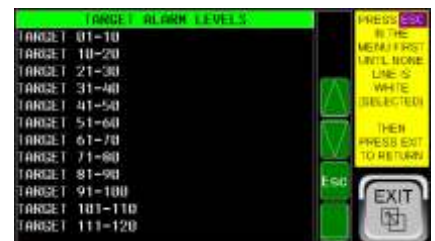
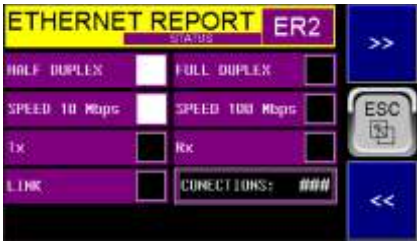
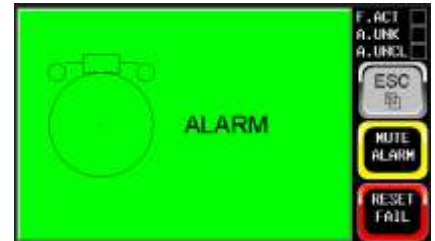

16b- MENU

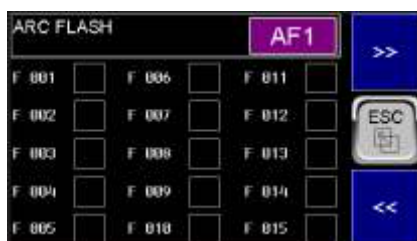

Easily accessible features
A complete set of screen (more than 200) allows you to access all the functionalities of the Zyggot relay and the system.

COD: V5FTA/O or V5FTA/M



RELAY 96 X 125 Touch Screen

Technical information

FEATURES: V5FTA THM+ARC RELAY

Power Supply	24 VDC
Humidity	5 to 95%
No. of sensors	up to 100 sensors
Resolution	1°C
Inputs	4 analog 4 digital (12 to 24VDC)
Outputs	2 Alarm and Trip outputs (N.O.) 2 programmable outputs (N.O.) 1 output for connection to sensors
Communication	Modbus RTU Devicenet (optional) Ethernet TCP-IP (optional)
Screen	Color, Touch Screen WVGA

COD: V5CON
(Comes with each Relay)



INTERFACE

COD: ZST/M/7/300/24



THM TUBULAR THM SENSOR

Technical information

FEATURES: EBLOCK 88x (x=D or x=R)

Power Supply	24 VDC (10 - 30 VDC) 2W
Moisture	5 to 95%
Communication	CAN
Temperature	Oper: 0 to 60 °C /// Armaz: -10 to +60 °C
Inputs	8 Digital Inputs (12 - 24 VDC)
Outputs	Model 88D = 8 Digital Outputs (DC) Model 88R = 8 Digital Output (Relay)
Inputs	Imp.: 10K /// Treshold: 8 VDC / 3 VDC
Distance Max	1000 M
Output Current (Model 88D)	2,5 A Max per point /// 10A Total Max (model 88D)
Output (mod 88R)	3,0 A @ 250 VAC Res. Max (mod. 88R)

COD: ZAG1R



GATEWAY PARA ARCO

COD: ZSB/M/60/120



THM BT SENSOR

Technical information

FEATURES: THM TUBULAR SENSOR

Measurement angle:	7°
Typical read error (*):	+/- 0,5°C (trg: 0-125°C)
Normal Distribution (100 s):	0.48°C at 80°C target
Emissivity:	Programmable (0,95 std)
Resolution:	1°C
Target reading:	0 to 300 °C
Environment reading:	0 to 75 °C
Power:	24 Vcc
Diameter:	19 mm
Length:	53 mm
Communication:	Modbus RTU
Material:	Stainless Steel / Polycarbonate

(* See test report at the end of this manual)

Technical information

FEATURES: ARC UVA SENSOR

Measuring angle:	90°
Power Supply:	24 VCC by the NET
Detection range:	UVA (240 to 380 nm)
Test sensitivity:	1 to 1,5 m (w/tester ZSA)
Real Arc Sensitivity:	up to 30 m
LED status indicator:	Included
Settings:	By PC software
Diameter:	19mm
Length:	53mm
Communication:	Rede CAN 512 MBs
Material:	Stainless Steel and Polycarbonate

COD: ZSA/90/24/UVA



UVA TYPE ARC SENSOR

Technical information

FEATURES: BT SENSOR

Measurement angle:	120°
Typical read error (*):	+/- 0,5°C (trg: 0-125°C)
Normal Distribution (125 s):	0.48°C at 80°C target
Emissivity:	Programmable (0,95 std)
Resolution:	1°C
Target reading:	0 to 120 °C
Environment reading:	0 to 75 °C
Power:	24 Vcc
Diameter:	54 mm
Length:	31 mm
Communication:	Modbus RTU
Material:	Polycarbonate

(* See test report at the end of this manual)

Technical information

FEATURES: ARC UVB SENSOR

Measuring angle:	90°
Power Supply:	24 VCC by the NET
Detection range:	UVB (220 to 320 nm)
Test sensitivity:	1 to 1,5 m (w/tester ZSA)
Real Arc Sensitivity:	up to 30 m
LED status indicator:	Included
Settings:	By PC software
Diameter:	19mm
Length:	53mm
Communication:	Rede CAN 512 MBs
Material:	Stainless Steel and Polycarbonate

COD: ZSA/90/24/UVB



UVB TYPE ARC SENSOR

Technical information

Connectors: EB/88D & EB 88R

1:	Digital Outputs / Relay Outputs
2:	NET address selection switches
3:	LEDs de status
4:	Inputs
5:	CAN & Power Supply
6:	Ground
7:	CAN RJ45

Technical information

FEATURES: ARC UV SENSOR OCTO

Measuring angle:	90°
Power Supply:	24 VCC by the NET
Detection range:	UVA (240 to 380 nm)
Test sensitivity:	50 to 80 Cm (w/test. ZSA)
Real Arc Sensitivity:	up to 20 m
LED status indicator:	Included
Settings:	By PC software
Diameter:	19mm
Length:	53mm
Communication:	Rede CAN 512 MBs
Material:	Stainless Steel and Polycarbonate

COD: ZSA/90/24/UV/OCT



UV TYPE ARC SENSOR OCTO

ACCESSORIES

Accessory

COD: VPS6024 ou VPS12024



POWER SUPPLY

Accessory

COD: ZSF2



Support for fixing and sight for tubular

Accessory

COD: VZX/B1/U ou VZX/B1/U/P



SUITCASE WITH LASER SIGHT

Accessory

COD: ZFR

COD: ZTA



COD: ZCB4/2U/xxx

Y-split Derivator, USB cables and terminating resistor

Accessory

COD: VLP2



Laser sight attachable to tubular sensor for startup

Accessory

COD: ZA232-2



SPLIT RS232

Accessory

COD: V5CON
(Comes with each Relay)



INTERFACE

Accessory

COD: RJ45/C2
(Comes with each V5CON module and each Eblock)



RJ45 CABLE

COD: EB/88D ou EB/88R
(For use with V5FTA relay)

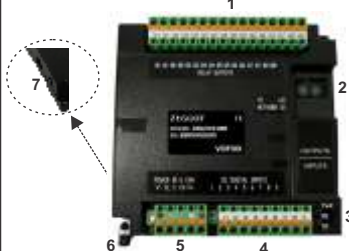

EBLOCK (Optional Use)

Included with every BT sensor

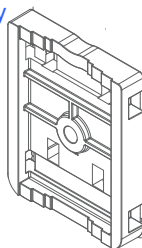

Quick Fixing Bracket for BT Sensor

COD: ZSA



ARCSAFE Arc Tester

ABOUT VARIXX

For over 40 years, Varixx has pursued its vocation for developing high-tech products and focuses its efforts on serving the industrial market with quality and speed. Our know-how in power electronics has allowed us to offer the market a wide range of products that have become known for their long service life and reliability. We were the creators of the global online thermography market, with the Zyggot line, which is becoming a global reference in the market for temperature monitoring and diagnostics and arc flash detection in electrical systems in general.

Our product portfolio also includes LED luminaires from our ONNO division, developed and manufactured 100% in Brazil with cutting-edge technology. Varixx values the introduction of innovative concepts worldwide.

AREAS OF ACTIVITY

- ✓ **MANUFACTURERS OF GENERATOR MACHINES AND SYNCHRONOUS MOTORS**
Static Exciters, Control Box Controllers, Low and Medium Voltage Soft Starters, Semiconductors
- ✓ **PRODUCTION OF ALUMINUM AND HYDROGEN / OXYGEN**
High Current Rectifiers, Solid State Contactors, Smart Relay for CCM, Online Thermography System and Arc Flash Detection and Onno LED Luminaires.
- ✓ **BASE INDUSTRY, MINING AND STEEL INDUSTRY**
Smart Relays for CCMs, Low and Medium Voltage Soft Starters, Solid State Contactors, AC/DC Converters for electromagnets, High Current Rectifiers, Online Thermography System, Arc Flash Detection and Protection and Onno LED Luminaires.
- ✓ **OIL COMPANIES**
Smart Relays for CCMs, Static Excitation, Low and Medium Voltage Soft Starters, Solid State Contactors, Online Thermography System, Arc Flash Detection and Protection and Onno LED Luminaires.
- ✓ **ELECTRIC PANEL ASSEMBLERS**
Smart Relays for CCMs, Online Thermography, Arc Flash Detection and Protection System, Semiconductors, Power Supplies and Onno LED Luminaires.

Why ZYGGOT Thermography And Arc Flash Protection?



SINGLE CABLE / EASY TO INSTALL



PREDICTIVE / DIFFERENTIAL PROTECTION



EFFECTIVE PROTECTION AGAINST ARC DESTRUCTION



WORLDWIDE UNIQUE BY UV DETECTION / NO CURRENT READING REQUIRED



DOES NOT NEED CONVENTIONAL THERMOGRAPHY / ALSO MEASURES AIR TEMP.



WITHOUT CONTACT / WITH NETWORK COMMUNICATION

LEARN MORE!

ZYGGOT ARC FLASH SYSTEM

- ✓ **Low Cost // Up to 100 sensors per relay.**
- ✓ **Innovative in the market // Faster (<300 uS versus up to 500 mS)**
- ✓ **Ultraviolet arc detection**
- ✓ **Does not operate with ambient light (False Alarm)**
- ✓ **No need current reading**

varixx

ALWAYS INNOVATING

www.varixx.com.br
vendas@varixx.com.br
+55 (19) 3424-4000
+55 (19) 3301-6900

R. Felipe Zaidan Maluf, 450
Distrito Industrial Unileste
Piracicaba-SP. CEP: 13422-190



@Varixxbrasil



@varixxcompany



Varixx Indústria Eletrônica



www.varixx.com.br

Representante/Distribuidor:

VARIXX USA

2229 Allen Parkway, Suite 200
+1 832-871-5700
Houston - Texas, 77019

VARIXX WORLDWIDE

MORE THAN 20 BRANCHES,
DISTRIBUTORS AND REPRESENTATIVE
OFFICES WORLDWIDE



ZYGGOT THERMOGRAPHY