



# ZYGGOT THERMOGRAPHY + ARC FLASH

ONLINE THERMOGRAPHY + ULTRA SELECTIVE ARC FLASH PROTECTION SYSTEM

## ZYGGOT V5FTA/O THM+ARC MONO GATEWAY ZYGGOT V5FTA/M THM+ARC MULTI GATEWAY



CONTINUOUS TEMPERATURE MONITORING + UV ARC FLASH PROTECTION SYSTEM

MANUAL

# INDEX

DESCRIPTION .....	3
KEY POINTS .....	4
TECHNOLOGY AND TECHNICAL DETAILS .....	5
TEMPERATURE MEASUREMENT CAPTURE AND EMISSIVITY INFLUENCE .....	6
TEMPERATURE MEASUREMENT CAPTURE AND PRODUCT COMPOSITION .....	7
TECHNOLOGY AND MAIN CHARACTERISTICS OF THE ARC SYSTEM .....	8
PRINCIPLE OF OPERATION OF THE ARC SYSTEM .....	9
ZAG1R GATEWAY OVERLAY AND SIDE LABEL .....	10
SYSTEM DETAILS RELATED TO THE ARC SYSTEM .....	11
EXAMPLE OF A TYPICAL APPLICATION WITH A 115 VAC / 125 VDC TRIP COIL .....	12
EXAMPLE OF A TYPICAL APPLICATION USING MULTIPLE GATEWAYS AND A SINGLE RELAY .....	13
EXAMPLE OF A TYPICAL APPLICATION USING MULTIPLE GATEWAYS WITHOUT RELAY .....	14
PROGRAMMING THE SENSORS WITH ZYGGOT SUPERGER SOFTWARE .....	15
USING THE ARC SAFE TESTER .....	16
COMPOSITION OF THE THM+ARC SYSTEM .....	17
ACCESSORIES .....	18
DETAILS OF THE V5CON AND EBLOCK INTERFACE .....	19
MEASUREMENT AREA, EMISSIVITY, MEASUREMENT ANGLES .....	20
SINGLE-LINE DIAGRAM USING EBLOCK AND MAIN CHARACTERISTICS .....	21
PROTECTIONS AND EMISSIVITY COMPENSATION WITH UNIDEX TAPE .....	22
TYPICAL CONNECTIONS (THM ONLY) .....	23
CONNECTIONS (THM ONLY) .....	25
TYPICAL INTERCONNECTIONS (THM ONLY) .....	25
MECHANICAL .....	27
TECHNICAL CHARACTERISTICS .....	28
TECHNICAL SPECIFICATIONS V5FTA RELAY .....	29
MAIN SCREENS FOR OPERATION .....	30
PROGRAMMING .....	52
TESTING THE ETHERNET CONNECTION .....	76
OPERATION .....	77
SCREEN FLOW .....	79
REPORT .....	84
PROGRAMMING.....	87
COMPUTER PARAMETERIZATION - ZYGGOT SUPERGER.....	89
SENSOR CONFIGURATION .....	93
FAIL SAFE SYSTEM .....	95
HOW TO DO IT .....	96
SUPERVISORY SOFTWARE .....	98
ASCII DATA TABLE OVER TCP/IP ETHERNET .....	101
MODBUS .....	102
ZYGGOT RELAY V5FTA MAP MODBUS .....	112
THM SENSORS NETWORK MODBUS SPEC .....	116
ARC GATEWAY MODBUS SPEC .....	117
ETHERNET IP SERVER DATA TABLE .....	119
ETHERNET MODULE IN STUDIO 5000/LOGIX DESIGNER ALLEN BRADLEY.....	123
BT SENSOR TEST REPORT .....	128
ABOUT VARIXX .....	130

**Nota:** Este Manual é redigido em Inglês USA e também está disponível no site [Varixx.com](http://Varixx.com) e [Varixx.com.br](http://Varixx.com.br) o mesmo manual em Português Brasil (PT-BR). O relé Zyggot sai de fábrica com 3 línguas selecionáveis, Inglês, Português e Espanhol podendo também ser fornecido com outras línguas, sob consulta.

**Note:** This manual is written in English USA and the same manual is also available on the website [Varixx.com](http://Varixx.com) and [Varixx.com.br](http://Varixx.com.br) in Brazilian Portuguese (PT-BR). The Zyggot relay leaves the factory with 3 selectable languages, English, Portuguese and Spanish, and can also be supplied with other languages, upon request.

# ZYGGOT THERMOGRAPHY

## TEMPERATURE +ARC FLASH MONITORING SYSTEM



### DESCRIPTION

Varixx was the world's first company to introduce a Continuous, Online, Networked Temperature Monitoring System in 2008 and is a market leader in this area. The low-cost ZYGGOT system was designed to allow online monitoring of the temperatures of low and medium voltage components and internal connections, transformers, motors, etc., replacing old methods of periodic thermography with cameras.

The ZYGGOT system introduced an important innovation to the market because current safety standards prohibit the opening of energized electrical panels for any type of measurement, including temperature measurements with manual point-of-care guns or thermography cameras, without the use of appropriate protective clothing.

An important feature of the ZYGGOT system is that it simultaneously measures both the target and the sensor body, which is equal to the temperature of the surrounding air.

This feature also allows the detection of an increase in the internal temperature of the panel, which can identify obstructions or ventilation failures or even an increase in the temperature of equipment not directly monitored.

Sensors with opening angles of 7° allow the monitoring of both well-defined points (points) and areas of any size, depending on the distance from the sensor to the area.

Varixx also introduced the world's first and only Ultraviolet arc detection system in 2014, which does not require confirmation of current rise and inhibits arc formation at its onset due to its extremely fast action (<250 μs), detecting the arc in its initial phase and not in the fourth phase of the arc, unlike existing systems that detect light and current, which only reduce the effect of the arc, already formed, thereby reducing the Incident Energy by around 80 to 150 times compared to the competition. It is a system that has already been widely approved, with hundreds of real cases of detection and action, with minimal or no damage to the protected systems, with a return to operation time of minutes to a few hours.

Furthermore, as it does not require current monitoring, it is very easy to implement and costs much less than light and current detection

systems.

In addition to the independent CTM and Arc Flash systems, which continue in the product portfolio, Varixx is introducing the integrated Continuous Temperature Monitoring + Arc Flash system, which saves panel door space and facilitates integration with the user's DCS system, featuring Modbus and Ethernet communication.



Gateway

Sensor UVB



Sensor UVA



Sensor Tubular



Sensor BT



### APPLICATION

On-line temperature monitoring and protection of electrical connections and components for low and medium voltage electrical panels, transformers, motors, brakes, processes, etc., and integrated protection against electric arcs (Arc Flash).

### BENEFITS

- \* Prevents opening of the energized panel.
- \* Dispenses with periodic thermography.
- \* Provides target and internal air readings.
- \* Non-contact measurement.
- \* Arc detection in phase 1 (pre-arc).
- \* Reduction in incident energy between 80 and 150 times compared to the competition.
- \* Indicates any sensor failure.
- \* Failure history.
- \* Modbus and Ethernet communication

### System Features

- \* Applicable in low and medium voltage.
- \* Up to 100 non-contact temperature sensors and 100 UV arc sensors in RS485 network with mini USB connections.
- \* Smart Sensors powered by the network itself.
- \* Measuring angle of 7° for temperature and 90° for Arc.
- \* Continuous temperature readings.
- \* Relay with color graphic touch screen display and Modbus and Ethernet communication.
- \* Fault history with "Time Stamp".
- \* Reading and over-temperature protection of up to 100 point or area targets in addition to 100 body/air temperatures.
- \* Arc Flash protection with up to 40 triggering Gateways, each with up to 100 sensors for Ultraviolet detection.
- \* Readings and protections related to 4 analog inputs.
- \* External fault monitoring.
- \* Sensor status monitoring.
- \* 4 programmable digital outputs.
- \* Each sensor has a flashing LED and can be controlled by the relay to facilitate its location and address on the network.
- \* Operation in «Fail Safe» mode
- \* **Ethernet protocols:**  
**TCP/IP (Modbus Slave): Modbus over Ethernet.**  
**Ethernet/IP: ODVA CIP over Ethernet.**  
**FTP: (File Server) File Transfer Protocol.**  
**ASCII over TCP/IP: ASCII Data over Ethernet.**  
**NTP Protocol: Network Time Protocol HTTP (Web Server): Hypertext Transfer Protocol (Web Server).**

## MAIN ADVANTAGES

- TESTABLE WITH SYSTEM OFF
- WITH ETHERNET
- INTEGRATES ARC PROTECTION
- WORLD'S MOST ADVANCED ARC PROTECTION
- HIGH SELECTIVITY FOR ARC (VERSION MULTI GATEWAY)
- ARC ACTUATION IN LESS THAN 250uS
- REDUCES INCIDENT ENERGY BY UP TO 150X
- DISPENSES CURRENT MEASUREMENT FOR ARC
- DOES NOT NEED CONVENTIONAL THERMOGRAPHY
- CAN MEASURE NON-VISIBLE POINTS
- MEASUREMENT WITHOUT ELECTRICAL CONTACT
- DOES NOT USE BATTERIES
- INDIRECTLY MEASURES THE ENTIRE SYSTEM (AIR)
- PROVEN RELIABILITY
- HISTORY OF EVENTS
- TEMPERATURE PLOT
- WORLD LEADING SYSTEM

The ZYGGOT system with stainless steel tubular sensors was developed for low and medium voltage panels. The THM sensors measure temperature without physical contact, by infrared detection, and allow local and online reading and protection for up to 100 targets per relay. Each sensor measures two temperature levels: the target and the air surrounding the sensor (case), allowing fault detection at unmeasured points, by indirect heating of the air. They are networked using mini USB cables, in sizes from 0.3 to 8.0 meters (supplied), which allows for quick, error-free installation without tools. The relay provides local protection and also through a supervisory system. Alarm and trip levels are freely programmable for each point. An eventual failure in one of the sensors does not interrupt the operation of the other sensors. The BT Sensor is applied in low voltage MCCs, which require a high number of sensors in a small space, in addition to demanding a low cost. Its quick-fix base can be fixed using a screw or a stainless steel strip directly to the bus to be monitored.

The Arc sensors are also connected to a CAN network to a Gateway.

## KEY POINTS

- Color Touch Screen.
- Has Ethernet communication with several protocols.
- Several built-in protections.
- UV arc protection, the most advanced in the world (Patent N° PI 0903809-4).
- Reduces incident energy by up to 150 times compared to light and current detection systems.
- Does not require current measurement to confirm an arc.
- Also available is a Multi Gateways version, which allows high selectivity for arc tripping, using a low-cost triggering Gateway per cubicle or per associated circuit breaker.
- Real-time graphical recording (Plot).
- History of failures and events.
- Continuous readings of target and surrounding air temperatures.
- Modbus RTU communication (and others).
- Networks of common temperature and arc sensors.
- Integrates arc protection with continuous thermography.
- Each relay presents up to 400 continuous measurements, namely: Temperature of 100 targets, Temperature of 100 sensor bodies (surrounding air), voltage of 100 temperature sensors plus 100 arc sensors (allowing monitoring of network integrity).

## APPLICATIONS

- Internal panels for online thermography (continuous temperature measurement) and arc flash protection.
- Transformer monitoring.
- Substation monitoring.

## MAIN FEATURES

- Reads temperature of up to 100 targets per relay. Reads temperature from up to 100 sensors (body / surrounding air), allowing detection of temperature increases at points not directly monitored.
- Reads supply voltage from up to 200 sensors (T+A).
- Up to 100 arc sensors per relay.
- Monitors Arc Flash by UV detection.
- Dispenses with current measurement for arc confirmation.
- Actuation in less than 250uS, in the pre-arc phase, reduces incident energy by up to 150x in relation to systems by light and current detection.
- Also available is a Multi Gateways version that allows high selectivity for arcing, allowing each circuit breaker to be tripped independently of the others, using a low-cost gateway per cubicle and a single relay per system..
- Configurable alarm and trip levels for temperature.
- Real-time graphic record for temperatures.
- Detection of differential temperature increases integrated into the relay and configurable by the user.
- Fault and status history.
- Continuous readings.
- 4 analog inputs with configurable alarm and trip levels.
- 8 digital inputs for external events or faults (ventilation, doors, etc.).
- Modbus RTU + Ethernet.



## HOW TO ENSURE ACCURATE READINGS ON BODIES OF LOW OR UNKNOWN EMISSIVITY.

For low emissivity bodies, such as polished copper, which has an emissivity of 0.06, it would be very difficult to obtain an accurate reading. This is not a problem for the Zyggot system, because once the Unidex tape is stuck on the area to be measured, the emissivity of the area becomes constant at 0.95. This index, once entered into the relay's memory, becomes the correction index for the measured temperature, also avoiding variations over time, which could occur with oxidation, which would increase the emissivity index. The Unidex tape, on the other hand, is stable and does not vary over time.

If all areas of interest, be it the material, copper, porcelain, PVC, etc., have the reading area covered with the Unidex tape, it is easy to see that when the equipment is started up, before putting it into operation, it can be fully calibrated in a few seconds, simply by programming all the emissivity indexes to the value of the Unidex tape, without having to calibrate different indexes for each material.

On the other hand, low-cost portable meters or even some high-cost ones do not have the possibility of calibrating the emissivity index, which is fixed at 0.95, leading to unreliable measurements. Since the Zyggot system allows calibration for each target, reliable measurements can be obtained even without the use of the Unidex tape.

## TOPOLOGY DESCRIPTION.

Each sensor has an LED that flashes under relay command to facilitate diagnosis and check the addressing.

Different Alarm and Trip levels for the target and sensor body temperatures (surrounding air) allow the protection system to be optimized. Each relay can monitor up to 100 THM sensors.

The Relay automatically indicates sensors that are not responding and also checks the supply voltage level reaching each one, allowing the detection of potential problems in the network, such as cabling exceeding the permitted extension.

The THM (thermal) sensors are connected directly to the Zyggot relay through an interface (V5CON) and the ultraviolet arc sensors are connected through 1 Gateway (or more Gateways (up to 40 ZGA1R) in the Multi Gateways version, allowing selectivity never before available worldwide for tripping specific circuit breakers in each cubicle). The relay is designed to read the target and body temperature values of the sensors, arc occurrence, arc sequence, temperature and arc sensor status, as well as power and communication voltages. Four or twelve digital outputs are available. Four digital inputs and four analog inputs are also available.

The data transmission method between sensors and relay uses RS-485 physical layer communication, with all sensors connected in parallel using shielded cables with mini-USB connectors that allow for quick installation and operation without the need for any tools.

The ZYGGOT THM+ARC system relay can be connected to a communication network with a supervisory system or remote monitoring. The ZYGGOT Relay has Ethernet communication with various protocols, and can be accessed from anywhere by mobile or non-mobile devices.

## ZYGGOT RELAY VZFTA.

- **Digital Outputs:** 04 Programmable.
- **Programming of parameters and values:** "On line".
- **Reading of Values:** Temperature of each target, Temperature of each sensor body (surrounding air), Supply voltage of each THM and ARCO sensor, Analog inputs.
- **Communication:** Serial RS232C and RS485 MODBUS RTU protocol for "Point to Point" connection, for use in network (Droop Out). CAN port with CsCAN Protocol or optional Devicenet.
- **Protections and Indications:** Alarm due to target over-temperature, Trip due to target over-temperature, Alarm due to differential heating of targets, Communication failure with the THM sensor network, Communication failure with each Gateway, Modbus communication failure, THM sensors not responding, Arc sensors not responding, Alarm due to over-temperature of the sensor body (surrounding air), Trip due to over-temperature of the sensor body (surrounding air), Alarm and Trip for up to 5 groups of independent sensors, Trip due to Arc Flash (arc-voltaic), Alarm due to Gateway not programmed correctly, Alarm or trip due to ARC Chain, Alarm and Trip due to external fault, Alarm and trip due to analog input levels, Fault Detection in each Gateway, Alarm due to fault related to the memory card, Active alarm screens, History screen with «Time Stamp», Bargraph with sensors being read, Alarm and trip statistics, Digital input and digital output status, Input levels Analog inputs, Temperature plot for each sensor and analog inputs, Indication of temperature differential and percentage of each sensor in relation to programmable time.
- **Fault actions:** Programmable for each fault in "None", "Log", "Alarm", "Trip".
- **Real-time clock:** Included.
- **Fault history:** with date and time.
- **Event memorization:** Unlimited events, memorized indefinitely until they are cleared with a password, for security.
- **Programmable digital outputs:** 4 on the Zyggot relay plus 8 on the optional EBLOCK module.
- **Programmable digital inputs:** 4 on the Zyggot relay plus 8 on the optional EBLOCK module.
- **Fail Safe System:** Yes
- **Memory Card:** Automatic and manual recording of temperature and arc reading data on the memory card for transfer to computers.
- **Active screens:** over 200 multiple screens.
- **Parameter programming:** By the relay itself, with passwords, by PC software (Free), by replication via memory card (program one and replicate it in all relays in the system) or by Modbus.
- **Single Gateway or Multi Gateways version:** Yes for high arc trip selectivity, can be connected to up to 40 Gateways, each with up to 100 Ultra-violet arc sensors.
- **Multi System:** Can be used only with THM sensors (temperature), only with Arc sensors or both.

# CAPTURING THE TEMPERATURE MEASUREMENT AND INFLUENCE OF EMISSIVITY

Every object with a temperature above absolute zero radiates electromagnetic energy. This radiation in the infrared range is not visible, as can be seen in the figure below.

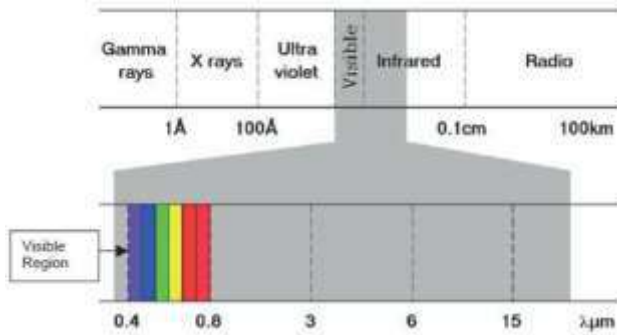

When radiation from one object reaches another object, some of the energy is absorbed, some is reflected, and if the body is not opaque, a portion is transmitted. The sum of the parts must always be equal to the total value that fell on the object. In view of these facts, in order to capture the temperature of desired targets, you must have sensors that capture such electromagnetic energy.

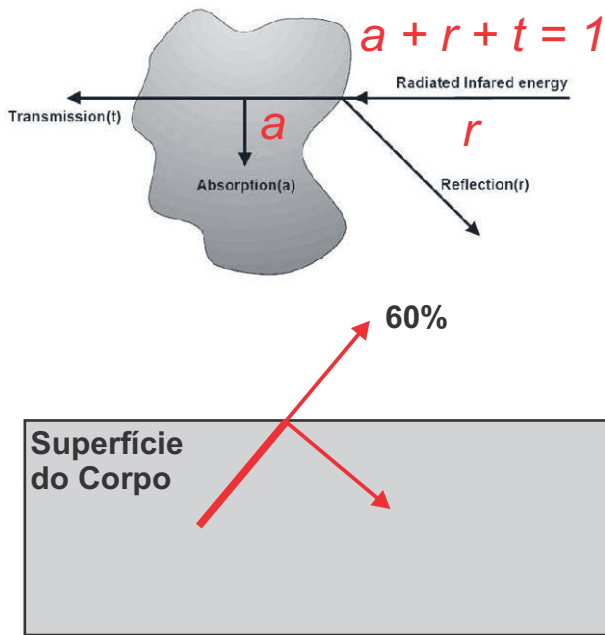

When a material is heated, its surface does not absorb all the energy and ends up emitting infrared energy. In practice, there is no material that is an ideal emitter of infrared radiation. The ideal emitter is called a black body. Objects tend to radiate less energy than black bodies even though they are at the same temperature.

The emissivity of an object is defined by:  $\epsilon = t/b$

$\epsilon$  = Emissivity;

$t$  = Radiation emitted at a certain temperature;

$b$  = Radiation emitted by a black body at the same temperature

The table below shows the emissivity range for various materials.

MATERIAL	EMISSIVIDADE (1µm)
Iron and Steel	0,35
Iron and oxidized steel	0,85
Aluminum	0,13
Oxidized Aluminum	0,40
Polished copper	0,06
Oxidized copper	0,80
Brick	0,80
Asphalt	0,85
Asbestos	0,90

There are some portable meters that do not have the possibility of varying the emissivity index, which leads to erroneous measurements since this index is fixed at 0.95. Zyggot sensors allow emissivity index configuration, ensuring accurate measurements on any material

## UNIDEX TAPE Solution for emissivity variations

Most metals have a change in emissivity due to oxidation. An example is copper, which under normal conditions has an emissivity of 0.06 and 0.80 when oxidized.

To avoid emissivity calibration readjustments of the sensors, the Zyggot System includes the supply of a special adhesive tape for temperatures up to 250°C, whose emissivity value of 0.95 is known and guaranteed by Varixx. With the Unidex tape glued over the measurement area of a target to be measured, we will always obtain the real temperature reading, without having to worry about the emissivity of the material.

Using the tape, it is not necessary to calibrate different indexes for each material.

The tape is supplied in dimensions of 50mm x 50mm or in a roll of 30m. For each sensor purchased by the customer, a tape drive is shipped.



UNIDEX TAPE  
ROLL  
(30 meters)

units de  
UNIDEX TAPE  
50m x 50m  
(ref. Zu50)

# TEMPERATURE MEASUREMENT AND PRODUCT COMPOSITION

## POSITIONING OF SENSORS AND TEMPERATURE READING

Each sensor measures both the target's temperature and body (air) temperature at the same time.

For the correct positioning of the sensors in the pre-defined configuration area the laser is aimed at the front of the sensor and the laser light is directed to the center of the area, as shown in the figure.

A positioning area must be defined on the desired target, having the diameter of the area defined by the sensor distance. The distance between a setup area and the sensor is a maximum of 8 times the setup area diameter value for 7° sensors. The maximum indicated distance to the target must be less than 2 meters. With the distance between the sensor and the target defined, you must enter the distance parameter in the sensor using the configuration software, which is better explained later on.

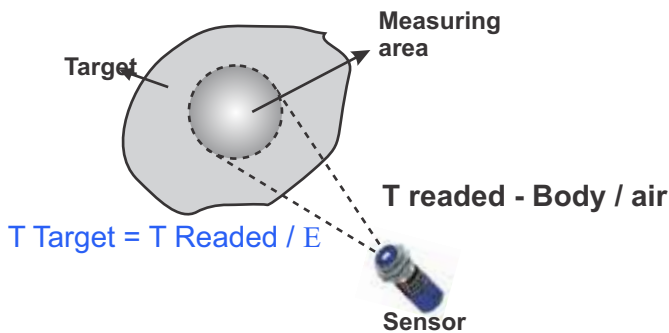

## SIGHT ANGLE

Sight angle is the angle between the perpendicular of the target area and the axis that crosses the sensor longitudinally.

The curve below shows that the emissivity would only begin to decrease after an angle of 55° in relation to the perpendicular of the measured object. It is recommended to use a maximum viewing angle of 45°

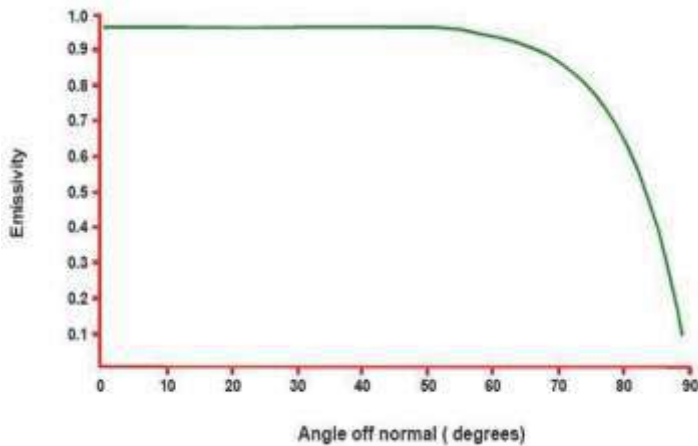

## Power supply

The Zyggot Tube Temperature System must be powered from an external source. The VPS12024 source is capable of supplying the 24 VDC needed to power the relay and sensors.

**Input:** 90~132 / 180~264 VCA // 120~375 VCC

**Output:** 24VCC/5A - 120W

## ZTA Derivator

The ZTA derivator (T connector) makes it possible to enable various types of topologies and layouts, facilitating the installation of the system. For more information, see pages 9, 10 and 11.

## Mini USB Cables

mini USB cable

The mini USB cable performs the communication between sensors and sensors/relay.

Cables are available in the following sizes:

- 0,3m - ZCB/4/2U/030
- 0,5m - ZCB/4/2U/050
- 1,0m - ZCB/4/2U/100
- 2,0m - ZCB/4/2U/200
- 4,0m - ZCB/4/2U/400
- 6,0m - ZCB/4/2U/600
- 8,0m - ZCB/4/2U/800

## INSTALLATION AND MAINTENANCE CASE

The Zyggot Temperature Installation and Maintenance Case (ref. VLP5) contains essential tools for installing and maintaining the sensors and relay.

Such tools are: laser sight (ref. VLP2) and USB configuration cable. It is important that this case is in the possession of the Zyggot Temperature System user, in order to carry out any maintenance properly.

## Laser sight

The laser sight is an essential tool to direct the sensor to the desired target. The sight makes installation easy.

## Configuration Cable (USB)

The USB configuration cable (ref. ZCC180) is used to connect the tubular sensor to the PC. Allows the configuration of each sensor by the Zyggot manager software

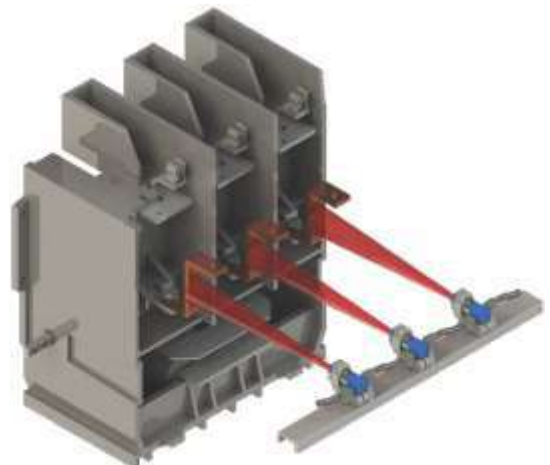

# TECHNOLOGY AND MAIN FEATURES OF THE ARC SYSTEM



The ZYGGOT Arc Flash Protection System, integrated in this product with the Zyggot V5FTA THM+ARC Temperature Monitoring Relay, was designed to allow full-time monitoring and protection against arc flash of low and medium voltage electrical equipment such as panels, transformers, motors and generators.

The ZYGGOT Arc Flash Protection System introduces an important innovation to the market due to the fact that it detects ultraviolet (UV) radiation from the beginning of the arc, that is, from the pilot path, in phase 1 of the arc, before the detection of light from other systems. The light phase is already the final phase of the arc, with expansion of gases and vaporization of copper and other metals. Another important advantage is that selective monitoring of ultraviolet radiation eliminates the need for simultaneous monitoring of the current to confirm the occurrence of the arc, which is required by visible light detection systems.

If ultraviolet radiation is emitted at certain levels, the system can be safely tripped. Systems that detect visible light could be activated by door openings or light entering through cracks, which requires simultaneous current monitoring to avoid undue tripping.

The ZYGGOT Arc Flash Protection System, unlike light detection systems, can be applied even under direct sunlight\*, thus opening up the possibility of using it in external systems (outdoor substations, transformers, motors, etc.).

The sensors have a 90° opening angle that allows monitoring large areas and practically an entire cubicle with a single sensor, since it even detects UV reflected on the internal walls of the panel, thus detecting the start of arcs in areas not directly targeted.

The effective monitoring distances are high due to the high sensitivity of the sensors. Each arc sensor, up to 100 per relay, is connected to a high-speed CAN network and this network is connected to a triggering Gateway, which is responsible for providing the trip signal at 300 uS, regardless of the speed of the Zyggot relay on the panel port. A single gateway and Zyggot relay can monitor up to 100 arc sensors per UV (plus 100 temperature sensors in the case of this system).

The interconnection of the sensors to the detection and triggering gateway uses a high-speed CAN network with clean and efficient wiring, unlike star systems, with analog or non-analog signals, which require each sensor to be independently connected to concentrator or interface modules. The high speed of detecting the occurrence of an electric arc and sending the trip signal (300 µs) ensures safety, because in the event of an electric arc, the sooner the energy is removed from the system, the less damage will be caused by the incident energy (up to 105 times less than systems with visible light).

Even when using circuit breakers with an opening time of tens of milliseconds, the system is guaranteed to trip, even if the network interconnection cable were destroyed by the arc, because before the destruction, the signal would have already reached the relay and the circuit breaker (in dozens of real protection cases that occurred over many years of use, no system was damaged, due to the high speed of operation, inhibiting the arc and not mitigating it). Another important difference is that the transmitted signals are digital, already processed in the microprocessor sensor and transmitted by shielded cables, therefore being immune to extremely strong electromagnetic fields generated by the arc current, unlike what can occur with visible light detection systems, with photocells, which transmit an analog signal to the interface.



### BENEFITS

- \* Monitors ultraviolet radiation in bands A and B.
- \* Detects phase 1 of the arc, before the visible light phase (i.e. expansion and destruction).
- \* Dispenses with simultaneous current monitoring to configure the occurrence of an arc.
- \* Sends the trip signal in less than 300 µs.
- \* A single Gateway + intelligent ZYGGOT relay with latest-generation ARM CORTEX microprocessors monitors up to 100 arc sensors per gateway (+100 temperature sensors per Zyggot relay).
- \* Reduction of up to 150 times in incident energy.
- \* Low implementation cost.
- \* High reliability.
- \* Allows for high selectivity, if necessary (Multi Gateways Version).
- \* "Open" system, does not depend on proprietary software, and can be interconnected to the DCS.

### PHASES OF THE ARC

**Pre-Arc:** Ionization of the air and formation of the path for the occurrence of an electric arc. In this phase, ultraviolet light is released (0 to 1 mS). This is the phase in which the arc sensor operates.

**Compression:** The energy of the arc is discharged into the air contained in the room, with a consequent increase in pressure (5 to 15 ms).

**Expansion:** The increase in pressure caused by the previous stage activates the relief mechanism and the air begins to be expelled to the outside, reducing the internal pressure (15 to 40 ms).

**Expulsion:** The pressure inside the room decreases, but the hot air continues to be expelled at an approximately constant pressure. The temperature potentially increases. The expulsion of air tends to be extinguished when the room's environment reaches the temperature of the arc (40 to 60 ms);

**Thermal:** The arc completely affects the insulating materials. The temperature reaches thousands of degrees Celsius and the conductive and structural materials begin to melt. This phase continues until energy dissipation occurs.

### MAIN SYSTEM FEATURES

- > Intelligent trigger gateway and relay (with ARM CORTEX microprocessors). Up to 100 gateways can be connected per relay.
- > Applicable in low and medium voltage.
- > High-speed CAN network for sensors.
- > Relay with Modbus RTU port for connection to PLCs.
- > Intelligent arc sensors powered by the CAN network itself.
- > 90° measuring angle.
- > Voltage and sensor status monitoring.
- > Does not require analog interfaces.
- > Gateway, sensors and relays can be configured and tested by PC with free software.
- > Allows high selectivity for tripping, using a low-cost triggering Gateway per cubicle/circuit breaker and a single Zyggot relay per system, or even dispensing with the relay (Multi Gateways Version).
- > Possibility of using only the Gateway, without the Zyggot relay, since the Gateway has Modbus communication and can be connected directly to the user's DCS system.
- > Up to 100 sensors connected to a single Gateway + Zyggot Relay. (Network with plug-in sensors).
- > Each sensor has an LED that flashes when commanded by the relay, to detect faults or their identification.
- > Trigger gateway with 3 digital outputs, one TRIP (solid state and mechanical) and two programmable.
- > Zyggot relay with 4 or 12 programmable digital outputs and 4 digital inputs for external faults, etc., in addition to 4 analog inputs.
- > Easy testing with ArcSafe hand-held tester (arc generator)

# PRINCIPLE OF OPERATION OF THE ARC SYSTEM

## PRINCIPLE OF OPERATION

Each sensor in the system has a high-speed, high-performance ARM CORTEX microprocessor. The firmware embedded in the sensor will operate communication and other tasks, but if an arc is detected, a high-priority interruption will occur and the arc detection data transmission routine, with the sensor number, will be immediately transmitted to the triggering Gateway and the Zyggot relay. The time from the detection of the arc by the sensor until the activation of the Gateway's TRIP output is approximately 300  $\mu$ s, activating a solid-state contact that supports 12 A continuously and up to 200 Amps peak for 5 cycles, plus a dry contact in parallel, allowing rapid actuation and a guarantee of permanence through the mechanical contact.

The Zyggot relay, with a color touch screen, has the function of acquiring data from the Gateway, without the need for speed since the trip occurs through the Gateway. After detection, the relay will show the sequence of arc occurrence, if more than one sensor is actuated.

The high-speed CAN network of arc sensors, connected to the Gateway, provides high detection speed and also the fact that the sensors detect the initial phase of the arc guarantees that even if the network cable were destroyed by the arc itself, the trip sequence will be terminated, protecting the system from catastrophic destruction (Note: in hundreds of real cases already reported by users, this has never happened. The system itself has never been destroyed, unlike light and current detection systems, which frequently suffer from this and there has also never been catastrophic destruction in real cases protected by Ultra-violet). The system will be protected even during the LED flash time or any other communication, because the CAN protocol has communication priorities, that is, more than one or even all network elements can generate communication at the same time and the one with the highest priority for all communication of lower priority packets is served immediately. Since the arc detection data packet is the one with the highest priority, the arc detection signal will be read immediately by the intelligent Gateway. If one or more sensors detect an arc, a list of these sensors will be displayed on the Zyggot V5FTA relay or even without the relay, this list will be available to the user on the Gateway via Modbus communication (and can therefore be used with or without the Zyggot relay, and in this case the Gateway can be configured using free software available on the Varixx website).

## Gateway Trip Output

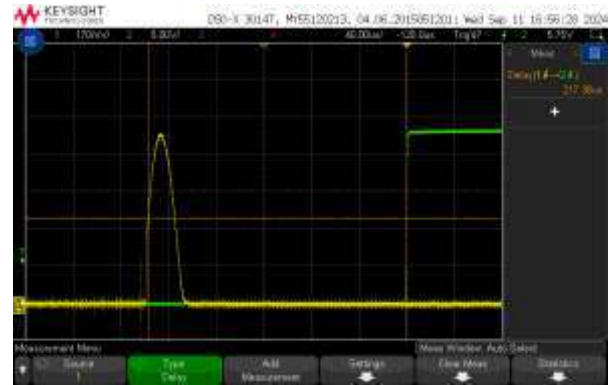

— Ocorrência do arco      — Saída de trip

## READING ANGLES AND REFLECTION

The sensor's opening (detection) angle defines the UV measurement area, i.e. the area where the occurrence of the arc can be detected.

UVA and UVB sensors have an opening angle of 90°, covering practically the entire area of a panel, depending on the attachment point. In a single-compartment cubicle, a single sensor installed at a suitable point, such as in one of the corners, may be sufficient.

Two sensors at opposite angles leave the entire volume without shadow areas. Ultraviolet radiation is reflected from surfaces like visible light (although it can be attenuated). Zyggot sensors can capture reflected UV radiation (depending on the reflected intensity), which facilitates detection throughout the volume of interest.

## SYSTEM RELATED TO THE ARCH

- A) 90° Arc sensor - ZSA/90/24/UVA
- B) 90° Arc sensor - ZSA/90/24/UVB
- C) ZAG1R gateway
- D) V5CON Interface for Zyggot relay
- E) Zyggot V5FTA THM+ARC relay
- F) Interconnection cable with mini-USB connector - ZCB/4/2U/...
- G) 24 VDC power supply VPS12024
- H) Tester (test arc generator) ZSA
- I) Termination resistor ZFR

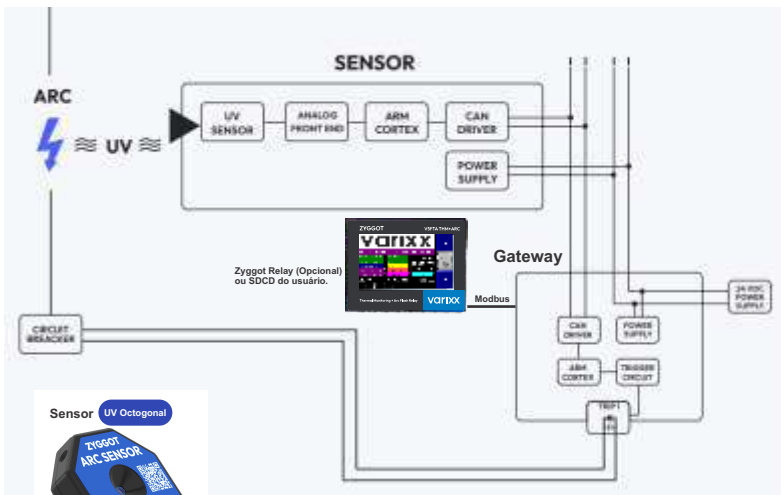

Arc Safe tester

\*DEPENDE DE INTENSIDADE DO ARCO.

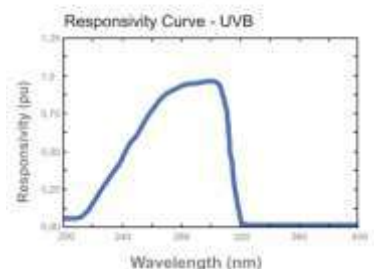
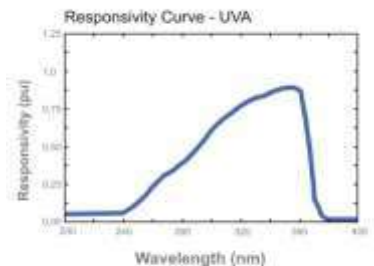

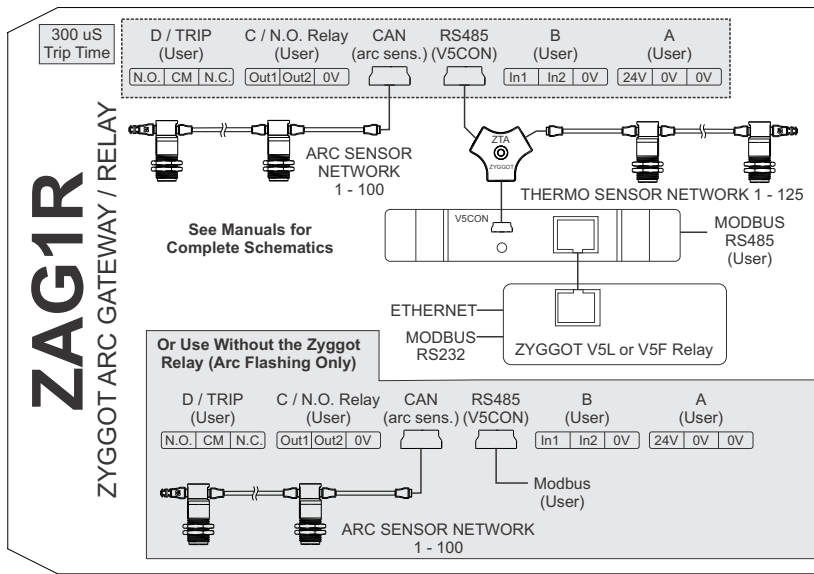
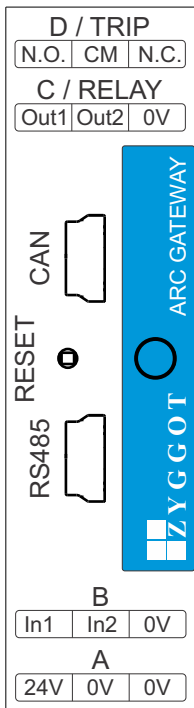

**ZYGGOT THM / ARC SYSTEM**  
 Autonomous or Integrated Arc Flashing Relay  
**ZYGGOT**  
**varixx**

### ZSA/90/24/UVA Sensor Features

- > Power supply: 24VDC via standard cable.
- > Opening angle: 90°.
- > LED indicator for location and faults.
- > Network addressing configurable via PC.
- > Detects UVA radiation and a small portion of visible light (240 to 340 nm).
- > Applicable in panels and sheltered environments.
- > Does not operate with ambient light or internal light from panels. (It may operate if pointed directly at UV light sources, such as clear sky, sun, flash or intense light).
- > Sensitivity to 2 cm electric arc produced by test device at a distance of 1 to 1.5 m or real arc at up to 30 m\*
- \* Depends on arc intensity (with 200A and 1 cm arc path the detection distance is 7 meters)

### ZSA/90/24/UVB Sensor Features

- > Power supply: 24VDC via standard cable.
- > Opening angle: 90°.
- > LED indicator for location and faults.
- > Network addressing configurable via PC.
- > Detects UVB radiation (220 to 320 nm).
- > Applicable in panels, open environments or monitoring equipment outdoors.
- > Does not operate even with strong visible light (except if pointed directly at the sun, whose rays contain UVB).
- > Sensitivity to a 2 cm electric arc produced by a test device at a distance of 0.2 m to 0.4 m or a real arc of up to 10 m\*.
- \* Depends on the intensity of the arc (with 200A and a 1 cm arc path, the detection distance is 3 meters).



### CABLES

The ease of assembling the sensor network lies in the two mini USB connectors present on the sensors and in the shielded mini USB cables supplied in different sizes by Varixx, ready to use.

### PROGRAMMING TOOLS

APC program is provided free of charge by Varixx and allows the parameterization and testing of the Gateway, Relay (which can also be programmed via the screen or online) and also the parameterization of each sensor.

### GATEWAY COMMUNICATION PORT

The ZAG1R Gateway has 2 communication ports: One RS485 port with Modbus RTU protocol, for communication with supervisory systems or with Zyggot V5FTA relay or for connection to a PC for parameterization and one mini USB port with CAN protocol, for communication with networked sensors.

### GATEWAY DIGITAL INPUTS

The Gateway has 2 digital inputs, 1 for Reset and 1 programmable by the relay or by the PC software. The "Reset" contact, if closed momentarily, performs the function of erasing the Gateway's alarms and trips, also erasing the Arc Flash occurrence sequence data.

### DIGITAL GATEWAY OUTPUTS

The Gateway has 3 digital outputs, 1 for TRIP and 2 programmable by the relay or by the PC software. The trip output has an ultra-fast acting solid state relay and another N.A. dry contact in parallel. The programmable outputs are normally open dry contact type.

### GATEWAY INDICATOR LED

The Gateway has 1 RGB LED, which will be «Green» if the gateway is programmed, configured and without alarms or trips. It will be «Yellow» in case of occurrence of alarms or trips that have not been reset or will be «Red» in case of a Trip that has not been reset.

**NOTE:** An alarm condition due to "Sensor not responding" or any other occurrence does not deactivate the "Armed" condition and the consequent detection in the event of an arc flash. For safety reasons, the system will be active for Arc Flash detection even in alarm.

### MINI USB MULTI-FUNCTION SENSOR CONNECTOR

The mini-USB connectors on the sensor are used for both parameterization, using a standard mini USB / USB cable (supplied separately) and a PC, and for communication with the Gateway via the network cable (supplied separately). The sensor's mini USB ports are parallel, so there is no difference between which port to connect the cable to. The dual mini-USB ports make it easy to set up the network. For details on how to parameterize the sensor, see the programming section.

### CAUTION

Do not connect the sensor to the computer with the other end of the sensor connected to the sensor network. This may damage the sensor and the computer!  
For parameterization, one sensor per month must be connected to the computer.



Gateway

# SYSTEM DETAILS RELATING TO THE ARC SYSTEM

## CABLE LENGTH SELECTION OF EACH SENSOR AND THE NEXT

The sensors are connected to the network using a shielded sleeve-type cable, without the need for any tools. These cables, which already have a mini USB connector on both ends, are supplied by Varixx in various lengths.

Below are the available codes and sizes.

CODE	CABLE LENGHT
ZCB/4/2U/030	CONNECTION CABLE WITH 0.3 M
ZCB/4/2U/050	CONNECTION CABLE WITH 0.5 M
ZCB/4/2U/100	CONNECTION CABLE WITH 1 M
ZCB/4/2U/200	CONNECTION CABLE WITH 2 M
ZCB/4/2U/400	CONNECTION CABLE WITH 4 M
ZCB/4/2U/600	CONNECTION CABLE WITH 6 M
ZCB/4/2U/800	CONNECTION CABLE WITH 8 M

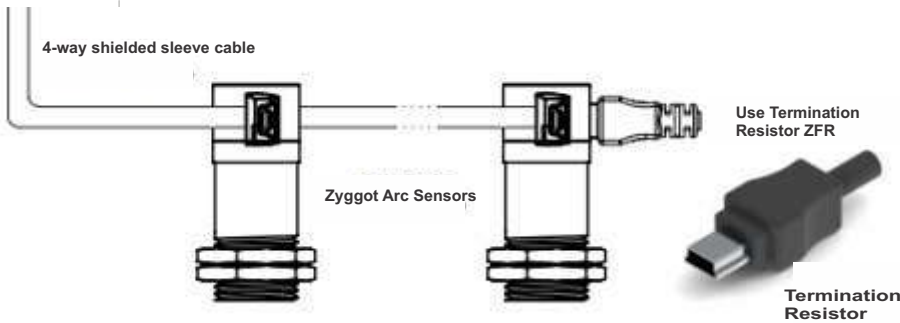

## TRANSIENT SUPPRESSOR IN THE GATEWAY TRIP CONNECTION

It is mandatory to use a type of transient suppressor compatible with the type of load. For trip coils (highly inductive), it is recommended to use a Varistor with appropriate characteristics. Possible variations for this circuit are "Free Wheeling Diode" (for DC power) and "Snubber" circuit composed of Resistor and Capacitor. This minimizes the generation of arcs in the 52a contact of CB1 and noise, increasing the useful life of the system and avoiding interference and improper operation of other equipment. If in doubt between the types of circuit, use the varistor. Consult the Circuit Breaker Manual.

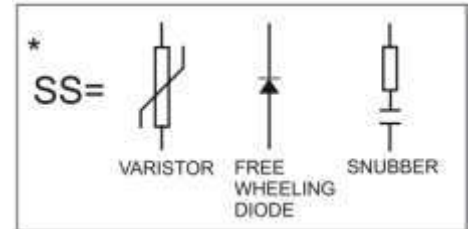

Reliability in the presence of strong electromagnetic fields. Stainless steel body and Faradex® polycarbonate with steel particles. Electromagnetic compatibility certification by the CPQD laboratory \* Sabc Trade Mark

ZYGGOT SPECIFICATIONS	
Arcing Sensors	(No Contact)
Tightening	2 x Nuts
Power Supply Types	By CAN Network
UV Wavelength	200 to 320 nm
Case Type	Stainless Steel
Sensor Measurement Angle	90°
Radiation Rages	UVA and UVB Insensible to visible and IR
Sensor Transmission Type	High Speed CAN
Temperature Operation	-20 to 89 °C
Temperature Storage	-40 to 125 °C
Maximum Measurement Rage (distance from sensor to target)	30 m depending on the Arc Power
Max. CAN Cable Lenght	500 m
Configuration (Address, Sensivity)	By Computer with Free Program
Indication	Led at rear face
Max. Sensors per Relay	100
CE	Compliant

## EXAMPLE OF TYPICAL APPLICATION WITH 115 VAC / 125 VDC TRIP COIL

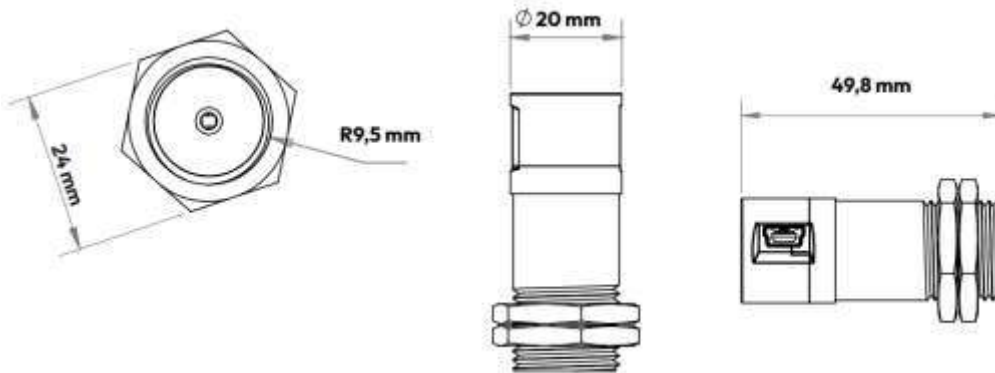
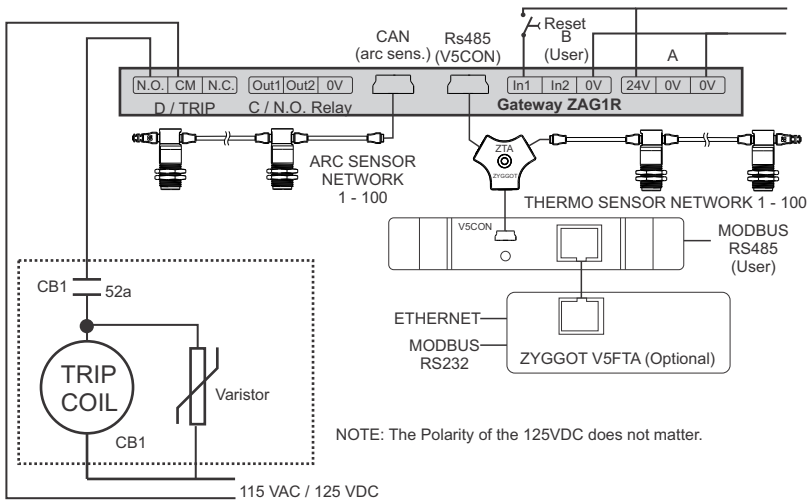

### PROGRAMMING THE SENSORS

- 1 - Download and install the free software "Zyggot Arco Configurador" from the Varixx website (<http://www.varixx.com.br>).
- 2 - Open the configuration program.
- 3 - Connect the sensor to the computer's USB port using a mini USB / USB cable (connect one sensor at a time). When the sensor is connected, its back light will turn on. The program automatically detects the sensor. If this does not happen, you can choose manual connection, choose the serial port corresponding to the USB to which the sensor cable is connected and press the Connect key to attempt a connection. When connecting (in both manual and automatic mode), a green light will turn on in the program indicating that the connection was successful.
- 4 - Program the sensor address (from 1 to 100) in the corresponding window and press Send to save the information to the sensor. Disconnect the sensor by simply removing it from the cable.
- 5 - It is advisable to label the sensor with its programmed address to make it easier to assemble in the field. If you wish to configure another sensor, return to step 3. Then check that there are no duplicate addresses between the sensors.
- 6 - Once all the sensors have been programmed with the addresses, fix the sensors in the defined positions using the two nuts on the front of the sensor. As a suggested assembly, we recommend using our metal "adjustable fixing bracket" (REF. ZSF2), with adjustable angle, which allows the use of just one Boelhoff rivet or similar in the chosen location, to fix the sensor and direct it.



**Ultraviolet Arc Sensor**  
**Wide Detection Area (90°)**  
**Detects at long distances (>7 meters**  
**with 200 A / 1 cm arc)**

### IDENTIFICATION OF ARC SENSORS

When the sensors are powered on, each sensor will flash its rear LED indefinitely until the first communication with the relay occurs. This allows for a quick check of communication with the relay and sensor integrity. If in doubt, disconnect the sensor and then reconnect it. The LED should flash for a very short time and then remain on continuously. If it continues to flash, it is because it is not communicating. Check the cables, programming the sensor address and programming the number of sensors in the relay. Obviously, if the sensor is not communicating, the relay will also indicate the lack of communication.

# EXAMPLE OF A TYPICAL APPLICATION USING MULTIPLE GATEWAYS AND A SINGLE RELAY

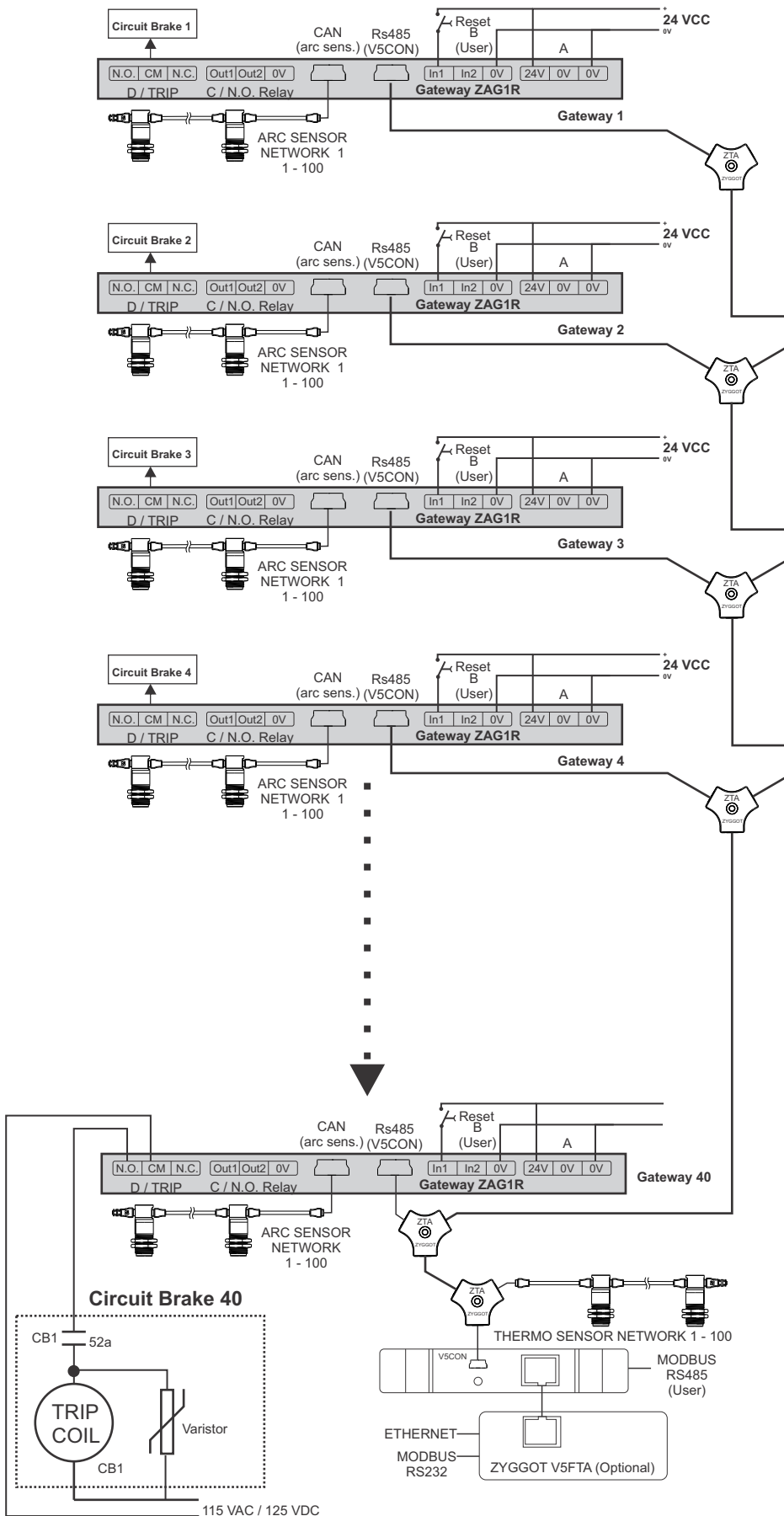

NOTE: The Polarity of the 125VDC does not matter.

In cases where high selectivity is required, such as in cases of distribution branches with one circuit breaker per branch, the side topology can be used with multiple triggering Gateways, each one triggering its own associated circuit breaker and using the relay to page information from up to 40 Gateways, each with up to 100 arc sensors, i.e. configuring a low-cost, high-efficiency system.

Even if several Gateways are associated with a single Zyggot relay, this relay can still monitor up to 100 target temperatures and up to 100 surrounding air temperatures, since the continuous temperature monitoring system is predictive, not requiring a "TRIP" but rather an "Alarm", unlike the ARC protection system where each Gateway sends the "TRIP" signal to its circuit breaker in less than 300  $\mu$ s.

# EXAMPLE OF A TYPICAL APPLICATION USING ONE OR MORE GATEWAYS WITHOUT RELAY

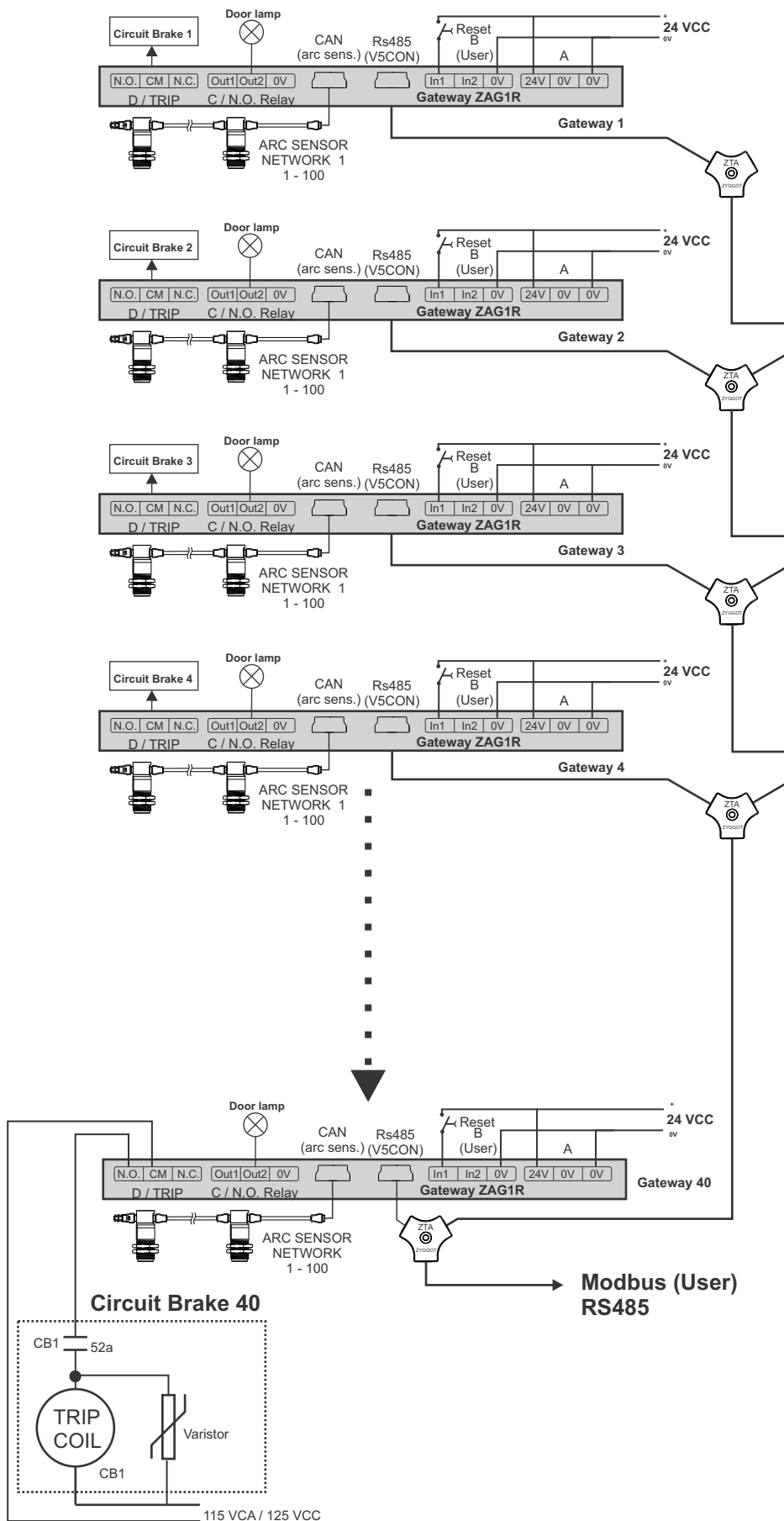

Note that it is possible to use only one Gateway with its sensors, which can be from 1 to 100, Zyggot. Typically, one Gateway per cubicle, associated with its circuit breaker, and 1 or two Zyggot UV Arc sensors would be enough to have each cubicle fully protected against Arc-voltaic.

NOTE: The Polarity of the 125 VDC does not matter.

# PROGRAMMING SENSORS WITH ZYGGOT SUPERGER SOFTWARE

## ZYGGOT ARCH SOFTWARE PROGRAMMING

Zyggot Arco is a configuration software that addresses and tests sensors, as well as parameterizes and configures relays. The software is available for free download from the Varixx website (<http://www.varixx.com.br>). The figure below shows the home screen of the Zyggot Arco software.

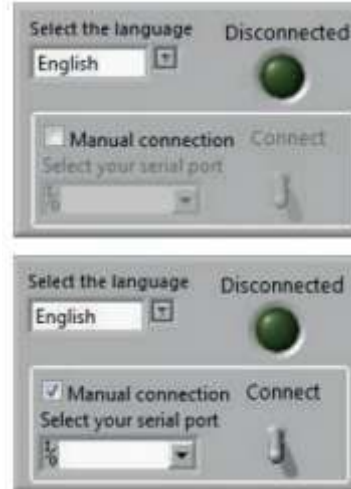

The software automatically recognizes the device and the port to which it is connected to the computer. If the port is not recognized, you can manually select the port using the Manual Connection box. When choosing to connect manually, you must select the serial port to which the device is connected and press the Connect button. When a sensor is connected to the computer, the program screen automatically changes to the image below. When connecting a sensor, the program automatically reads the address settings.

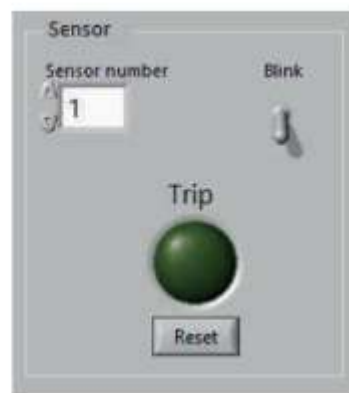
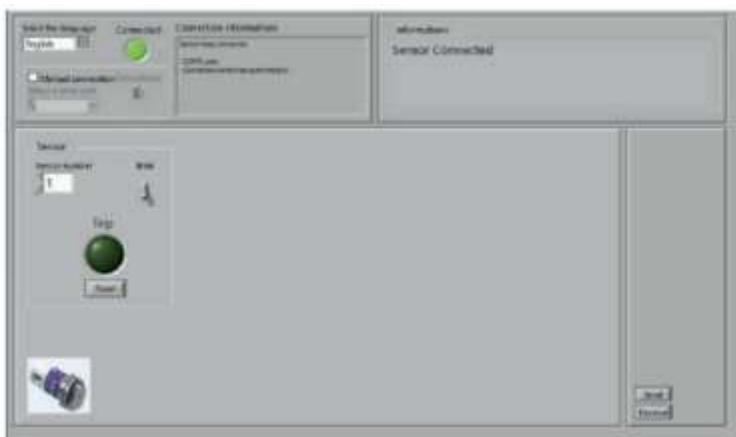

To set a new address for the sensor, you must change the sensor number in the Sensor tab. When you do this, the sensor number will flash red, indicating that the modification has not yet been sent to the sensor. To save the modification, press the Send button. The sensor's Trip indicator is also available on the Sensor tab. Use the ArcSafe tester to generate an arc in front of the sensor. When an arc is detected, the Trip indicator will change to red, and the LED on the back of the sensor will flash for a few moments. To restore the sensor's status, press the Reset button. Use the Blink key to make the LED on the back of the sensor flash indefinitely. Press again to stop. When you want to disconnect the sensor, simply remove it from the mini USB port.

# USING THE ARCSAFE ZSA TESTER

## OPERATION TEST USING ARCSAFE TESTER (ZSA)

The ArcSafe tester generates very low current arcs, which represents a low risk of injury. However, the risk is not zero, and can cause serious muscle damage and even death, especially if the operator is in special conditions such as high places or confined spaces, which can lead to falls or collisions with objects or live parts and involuntary movements in the event of an impact. Use the ZSA with extreme care and attention.

Always turn off the slide switch when it is not in operation. Only turn on the switch just before each test and turn it off immediately afterwards. Each time the switch is turned on, the front light will flash and the LED to indicate that it is on will light up.

The figure on the side shows the ArcSafe Varixx tester (supplied separately) for testing system operation. The ArcSafe is rechargeable in a 110 or 220 VAC outlet. The equipment generates an extra high voltage (3,800,000 Volts) generating small low-energy electric arcs between its electrodes, which are detected by the sensor up to an average distance of 1 meter (UVA sensor) within its viewing angle. You can hold down the trigger button to generate a sequence of arcs (the arc detection by the sensor and relay will always be on the first arc) or quickly press the button to generate a single arc.



## HOW TO RUN SYSTEM TEST WITH ARCSAFE GENERATOR

- Assemble the system completely and make sure that the relay is indicating Armed, that is, monitoring the occurrence of an arc. In this condition, there will be no indication of previous trips.

Note that the condition of sensors not responding only activates the Alarm output, not preventing the Armed condition, since even with some sensors in the network not responding, others may be operational and active. It is highly recommended to use the Alarm output for indication on the DCS system or panel door.

- For each sensor to be tested, position the ZSA arc generator in front of the sensor, within the 90° viewing angle, that is, up to 45° from the straight line extending from the center of the sensor.

Remember to comply with the maximum detection distance of the tester for UVA (1.5 m) and UVB (0.2 m) sensors.

Note: in the case of a real arc, the detection distances are greater due to the large amount of energy released in UV radiation. Real arcs can be detected at a distance of up to 30 m\*.

- Preferably generate a single arc by quickly pressing the ArcSafe trigger button.

- The arc will be detected and the Trip output will be activated, with the Trip LED on the relay and the corresponding sensor indicating the arc. (The rear LED on the sensor will also flash for a few moments).

- After checking that it is operating correctly, reset the relay by pressing and holding the front RESET/ENTER button or the RESET/INHIBIT contact for a few moments.

- Repeat the test operation for each sensor in the system.

\* Maximum detection limit for sensors. The actual detection distance of an arc depends on the intensity at which the arc occurs.

## CAMERA FLASH TEST

Common camera flashes are also a spark gap in an inert gas bulb, and so most flashes emit ultraviolet light in addition to visible light. More modern LED flashes also have a percentage of ultraviolet light.

UVA sensors can detect some of these flashes, while UVB sensors have a lower detection spectrum and are therefore more immune to photographic flashes.

Note: Not all photographic flashes emit UV radiation.

COD: V5FTA/O or V5FTA/M

**RELAY 96 X 125 Touch Screen**

**Technical information**

**FEATURES: V5FTA THM+ARC RELAY**

Power Supply	24 VDC
Humidity	5 to 95%
No. of sensors	up to 100 sensors
Resolution	1°C
Inputs	4 analog 4 digital (12 to 24VDC)
Outputs	2 Alarm and Trip outputs (N.O.) 2 programmable outputs (N.O.) 1 output for connection to sensors
Communication	Modbus RTU Devicenet (optional) Ethernet TCP-IP (optional)
Screen	Color, Touch Screen WVGA

COD: V5CON  
(Comes with each Relay)

**INTERFACE**

COD: ZST/M/7/300/24

**THM TUBULAR THM SENSOR**

**Technical information**

**FEATURES: EBLOCK 88x (x=D or x=R)**

Power Supply	24 VDC (10 - 30 VDC) 2W
Moisture	5 to 95%
Communication	CAN
Temperature	Oper: 0 to 60 °C /// Armaz: -10 to +60 °C
Inputs	8 Digital Inputs (12 - 24 VDC)
Outputs	Model 88D = 8 Digital Outputs (DC) Model 88R = 8 Digital Output (Relay)
Inputs	Imp.: 10K /// Treshold: 8 VDC / 3 VDC
Distance Max	1000 M
Output Current (Model 88D)	2,5 A Max per point /// 10A Total Max (model 88D)
Output (mod 88R)	3,0 A @ 250 VAC Res. Max (mod. 88R)

COD: ZAG1R

**ARC GATEWAY**

COD: ZSB/M/60/120

**THM BT SENSOR**

**Technical information**

**FEATURES: THM TUBULAR SENSOR**

Measurement angle:	7°
Typical read error (*):	+/- 0,5°C (trg: 0-125°C)
Normal Distribution (100 s):	0.48°C at 80°C target
Emissivity:	Programmable (0,95 std)
Resolution:	1°C
Target reading:	0 to 300 °C
Environment reading:	0 to 75 °C
Power:	24 Vcc
Diameter:	19 mm
Length:	53 mm
Communication:	Modbus RTU
Material:	Stainless Steel / Polycarbonate

(\* See test report at the end of this manual)

**Technical information**

**FEATURES: ARC UVA SENSOR**

Measuring angle:	90°
Power Supply:	24 VCC by the NET
Detection range:	UVA (240 to 380 nm)
Test sensitivity:	1 to 1,5 m (w/tester ZSA)
Real Arc Sensitivity:	up to 30 m
LED status indicator:	Included
Settings:	By PC software
Diameter:	19mm
Length:	53mm
Communication:	Rede CAN 512 MBs
Material:	Stainless Steel and Polycarbonate

COD: ZSA/90/24/UVA

**UVA TYPE ARC SENSOR**

**Technical information**

**FEATURES: BT SENSOR**

Measurement angle:	120°
Typical read error (*):	+/- 0,5°C (trg: 0-125°C)
Normal Distribution (125 s):	0.48°C at 80°C target
Emissivity:	Programmable (0,95 std)
Resolution:	1°C
Target reading:	0 to 120 °C
Environment reading:	0 to 75 °C
Power:	24 Vcc
Diameter:	54 mm
Length:	31 mm
Communication:	Modbus RTU
Material:	Polycarbonate

(\* See test report at the end of this manual)

**Technical information**

**FEATURES: ARC UVB SENSOR**

Measuring angle:	90°
Power Supply:	24 VCC by the NET
Detection range:	UVB (220 to 320 nm)
Test sensitivity:	1 to 1,5 m (w/tester ZSA)
Real Arc Sensitivity:	up to 30 m
LED status indicator:	Included
Settings:	By PC software
Diameter:	19mm
Length:	53mm
Communication:	Rede CAN 512 MBs
Material:	Stainless Steel and Polycarbonate

COD: ZSA/90/24/UVB

**UVB TYPE ARC SENSOR**

**Technical information**

**Connectors: EB/88D & EB 88R**

1:	Digital Outputs / Relay Outputs
2:	NET address selection switches
3:	LEDs de status
4:	Inputs
5:	CAN & Power Supply
6:	Ground
7:	CAN RJ45

**Technical information**

**FEATURES: ARC UV SENSOR OCTO**

Measuring angle:	90°
Power Supply:	24 VCC by the NET
Detection range:	UVA (240 to 380 nm)
Test sensitivity:	50 to 80 Cm (w/test. ZSA)
Real Arc Sensitivity:	up to 20 m
LED status indicator:	Included
Settings:	By PC software
Diameter:	19mm
Length:	53mm
Communication:	Rede CAN 512 MBs
Material:	Stainless Steel and Polycarbonate

COD: ZSA/90/24/UV/OCT

**UV TYPE ARC SENSOR OCTO**

# ACCESSORIES

Accessory

COD: VPS6024 ou VPS12024



POWER SUPPLY

Accessory

COD: ZSF2



Support for fixing and sight for tubular

Accessory

COD: VZX/B1/U ou VZX/B1/U/P



SUITCASE WITH LASER SIGHT

Accessory



Y-split Derivator, USB cables and terminating resistor

Accessory

COD: VLP2



Laser sight attachable to tubular sensor for startup

Accessory

COD: ZA232-2



SPLIT RS232

Accessory

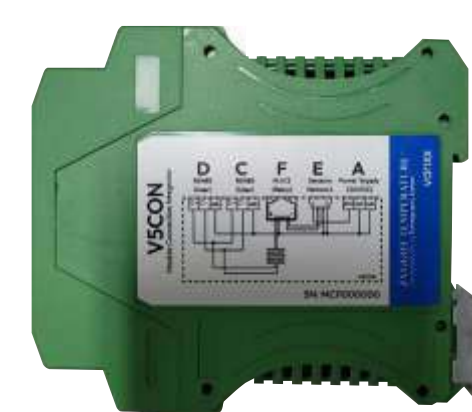

COD: V5CON  
(Comes with each Relay)

INTERFACE

Accessory

COD: RJ45/C2  
(Comes with each V5CON module and each Eblock)



RJ45 CABLE

COD: EB/88D ou EB/88R  
(For use with V5FTA relay)

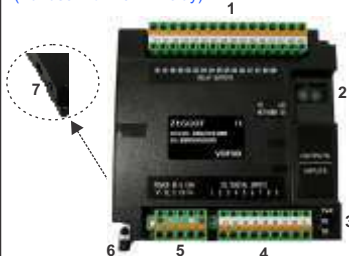

EBLOCK (Optional Use)

Included with every BT sensor

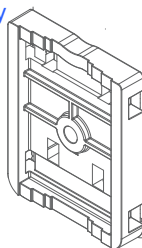

Quick Fixing Bracket for BT Sensor

COD: ZSA



ARCSAFE Arc Tester

# V5CON AND EBLOCK INTERFACE DETAILS



The V5CON interface simplifies the connection of the Zyggot V5FTA relay to the sensor network, power supply and also integrates the sensor network termination resistor at the end of the relay and two RS232C to RS485 converters, more suitable for long distance communication. It must be installed on a quick fixing rail at the base in the same cubicle where the Zyggot relay is installed.

### V5CON INTERFACE CONNECTIONS (All on top)

Port A (Power): Connection for the system's 24 VDC power supply. VPS6024 OR VPS 12024 power supplies.

Port F (Relay): Connection with RJ45 cable between the Interface and the Zyggot relay.

Port E (Sensor Network): Connection with cable and mini USB connector between the Interface and the sensor network.

Port C (Rs485): RS485 serial connection between the relay and the user's DCS system.

Port D (Rs485): RS485 serial connection between the relay and the user's DCS system.



Label

V5CON Interface

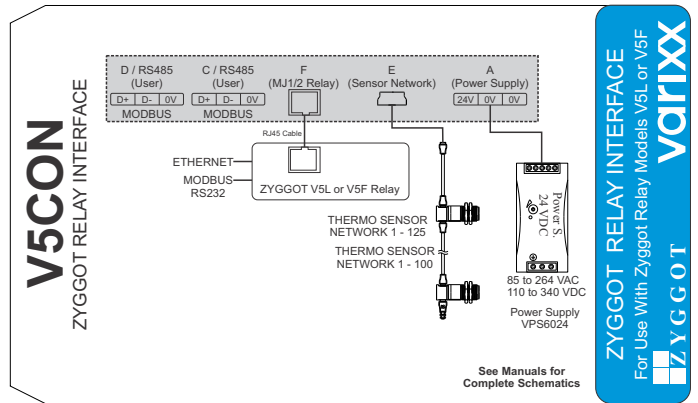
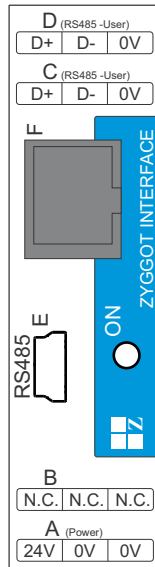

The EBLOCK 88D module adds 8 digital outputs and 8 programmable digital inputs to the Zyggot V5FTA relay. The EBLOCK 88R module adds 8 relay outputs (dry contacts) and 8 programmable digital inputs to the Zyggot V5FTA relay. These modules are optional.



EBLOCK 88R

Digital Outputs		
D. OUT. 1	ALARM	Q1 RELAY
D. OUT. 2	TRIP	Q2 RELAY
D. OUT. 3	D.O. 3	Q3 RELAY
D. OUT. 4	D.O. 4	Q4 RELAY
D. OUT. EB1	AUX 1	Q1 EBLOCK
D. OUT. EB2	AUX 2	Q2 EBLOCK
D. OUT. EB3	AUX 3	Q3 EBLOCK
D. OUT. EB4	AUX 4	Q4 EBLOCK
D. OUT. EB5	AUX 5	Q5 EBLOCK
D. OUT. EB6	AUX 6	Q6 EBLOCK
D. OUT. EB7	AUX 7	Q7 EBLOCK
D. OUT. EB8	AUX 8	Q8 EBLOCK

Digital Inputs		
D. INP. 1	EXT. F. 1	I1 RELAY
D. INP. 2	EXT. F. 2	I2 RELAY
D. INP. 3	MUTE	I3 RELAY
D. INP. 4	RESET	I4 RELAY
D. INP. EB1	AUX 1	I1 EBLOCK
D. INP. EB2	AUX 2	I2 EBLOCK
D. INP. EB3	AUX 3	I3 EBLOCK
D. INP. EB4	AUX 4	I4 EBLOCK
D. INP. EB5	AUX 5	I5 EBLOCK
D. INP. EB6	AUX 6	I6 EBLOCK
D. INP. EB7	AUX 7	I7 EBLOCK
D. INP. EB8	AUX 8	I8 EBLOCK



Detail of the EBLOCK RJ45 connector for communication with the relay (CAN)

# MEASUREMENT AREA, EMISSIVITY, MEASUREMENT ANGLES.

Areas as a function of distance for the 7th sensor  
**Area diameter = Distance / 8**

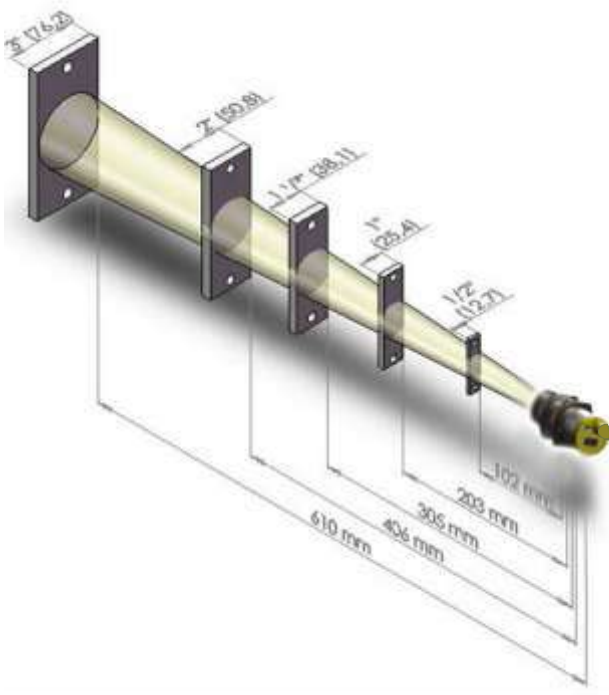

## AVAILABLE READING ANGLES.

The THM Tubular Sensor is supplied with a standard reading angle of 7° (other angles can be supplied on request).  
 The BT Sensor has a measuring angle of 120°

**Perfect aiming of the object is guaranteed with a removable laser sight.**

**You can measure objects up to 10 meters away with automatic compensation.**

Reading errors, which can occur and usually go unnoticed, with measurements using manual guns or even thermographic cameras due to differences in the emissivity of the materials.

With the Zyggot sensor pointing at a Unidex tape or even a copper busbar coated with heat shrinkable (which has an emissivity of 0.95 like the Unidex tape), you get an accurate temperature reading, since the sensor is calibrated to 0.95

In short, it is not possible to rely on manual non-contact measurements when dealing with multiple materials, without calibrating the meter for each type of emissivity.

The Zyggot system solves this problem and also provides real-time measurements.

## SELECTION OF CABLE LENGTH FOR EACH SENSOR.

The tubular sensors are connected by a shielded multi-cable with mini USB connectors at both ends. Each sensor has 2 mini USB connectors, making it easy to chain one sensor to the next and so on up to the relay. The connection cables are supplied in different lengths to facilitate installation. The use of ZTA shunts facilitates installation and can be used freely.

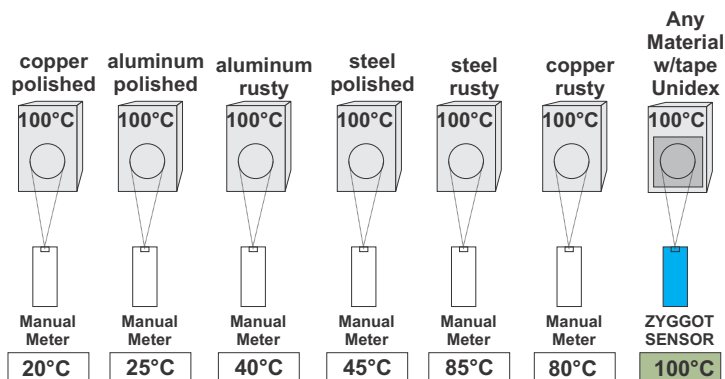

# ONE WIRE DIAGRAM AND MAIN FEATURES

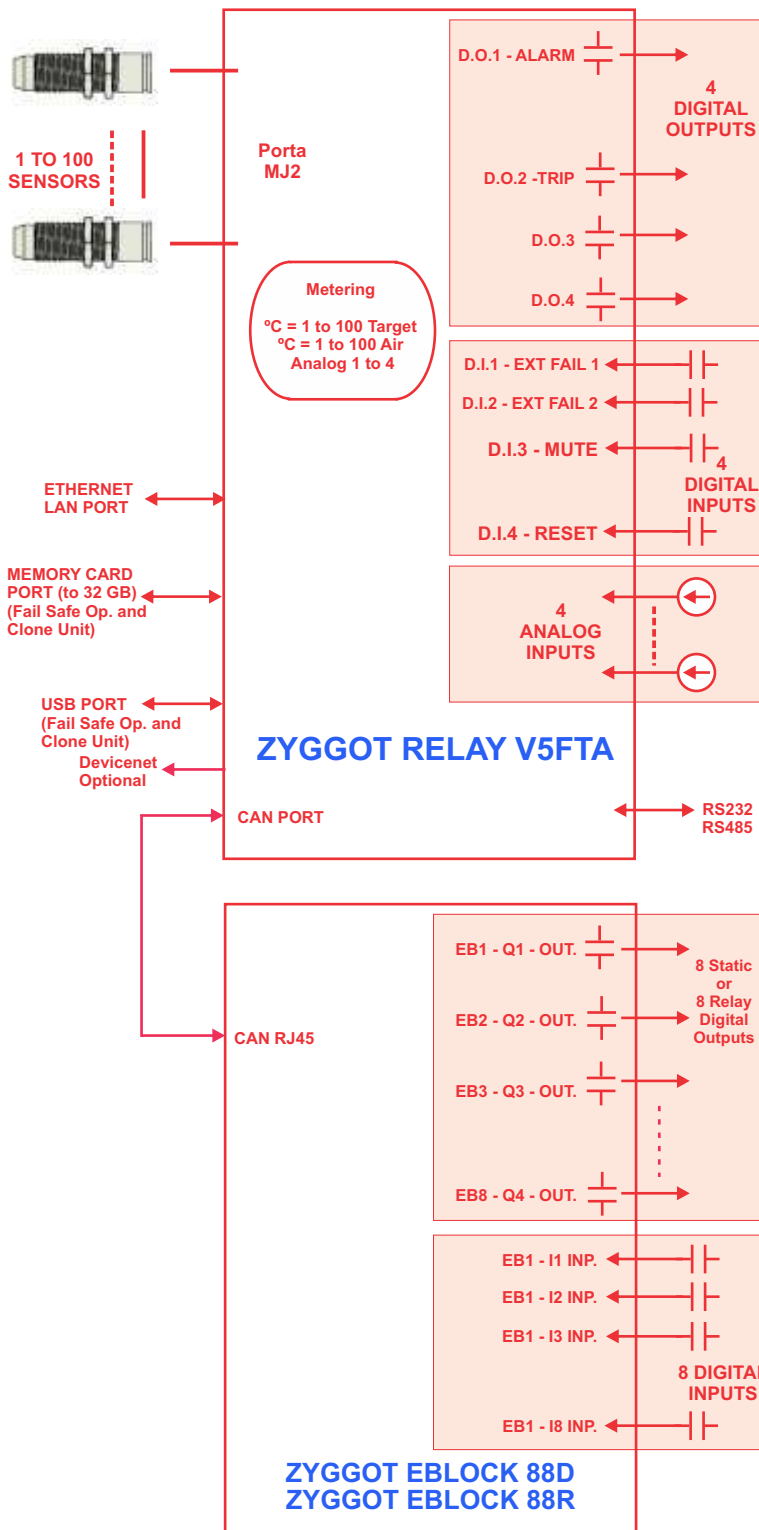

## Measurement

The Zyggot Relay provides accurate measurement of:

- \* Up to 100 target or area temperatures.
- \* Up to 100 air temperatures surrounding the sensor.
- \* 4 12-bit analog inputs for measurement and protection of external variables, such as other temperatures acquired by thermocouples etc.
- \* Operating hours.
- \* Integrity of sensors on the network (Not Responding or OK).

## Display

Touch Screen graphic display, with trending capability. Trending shows in real time in graphs of up to 3 sensors per screen the real behavior of any temperature or analog input. 64k colors.

## Aiming tool

A laser pointer can be screwed onto the front of the sensor body only during installation, allowing quick and safe attachment of the sensors, then being removed. A single pointer is both necessary and sufficient.

## Programming tools

A free program developed with graphical windows is provided free of charge by Varixx to further facilitate the parameterization of the relay. Even without this program, it is very easy to parameterize the relay via the HMI, with interactive and user-friendly menus. Another program tests and parameterizes each sensor (emissivity and address).

You can also clone one relay to another.

## Event memory

The relays allow the memorization and indication of the last 120 faults with date and time of occurrence. These indications are not lost even if the relay is turned off.

## Communication ports

The ZYGGOT V5FTA relay has 1 RS232 or RS485 programmable communication port with converter, which can be used for communication with supervisory systems or PLCs with Modbus RTU communication protocol. Another CAN port with CsCAN or Devicenet protocol (Optional) allows communication and expansion.

There is a USB port and a Memory Card port up to 32 GB. An ETHERNET LAN port is also available.

## Analog Inputs

The Zyggot V5F relay has 4 12-bit analog inputs that can be used for measurement and protection, linked to external temperature and other transducers.

## Digital Inputs

Zyggot V5FTA relays have 4 configurable digital inputs, which can for example be connected to panel door micro switches or ventilation airflow sensors.

## Digital outputs

4 digital static outputs are available on the relay and 8 digital static outputs (model Eblock 88D) or 8 relay outputs (dry contact) (model Eblock 88R), all configurable for alarm or trip, to indicate any of the faults. Digital outputs are available to indicate any of the faults.

## Topology

Tubular sensors allow quick and easy installation and parameterization.

# PROTECTIONS AND COMPENSATION OF EMISSIVITY WITH UNIDEX TAPE

## FACTORS THAT INFLUENCE THE ACCURACY OF TEMPERATURE READINGS AND ZYGGOT SYSTEM

- \* Wave-length → ✓ Sensor calibrated in the optimal range
- \* object surface → ✓ Automatic emissivity correction
- \* Sight angle → ✓ Up to 60° without error introduction
- \* sensor temperature → ✓ Readed and corrected internally

## FUNCTION TABLE

### PROTECTIONS AND FUNCTIONS

ANSI	DESCRIPTION	TRIP	ALARM	Monitor
94	2 x Assignable External			
49	100 Target Overtemperature			
49	100 Case / Air Overtemp.			
30	Anunciator w/ Time Stamp			
	Several Communication Options			
	Event Recorder			
	Readings 4 External Analog Signal			
	Readings - 100 Target °C			
	Readings - 100 Case / Air °C			
	Trendings - Real time curves			



#### Unidex adhesive tape

In the photo you can see a roll of Unidex adhesive tape, with known and constant emissivity, from room temperature to 250°C, which can be cut and glued in the areas of interest, guaranteeing accurate readings. If the target material has low emissivity, stick the Unidex tape supplied with the sensor to cover the area to be measured. If you do not use Unidex tape, take into account the emissivity index of the target, according to table 1 or by comparison, when programming each emissivity index in the sensor. The use of Unidex tape is recommended for ease of calibration and better accuracy of readings.

The perfect sight of the object is guaranteed with aim Removable laser.

#### LASER SIGHT

Once the sensors are installed, the pointing direction must be checked, precisely at the target. For this, a laser sight is used, which is supplied as an accessory, in a case that contains the sight and battery power supplies. The Laser sight must be screwed onto the front of the sensor. Once correctly aimed at the target (if using a special bracket supplied as an accessory, this adjustment is very easy). Once the correct sight has been checked, the screw support is removed. If the sensor is relatively close to the target this process can be dispensed with, if the support has been designed correctly to already have a correct position.

#### Briefcase with Laser Sight (used for the Tubular sensor)



# TYPICAL CONNECTIONS (THM ONLY)

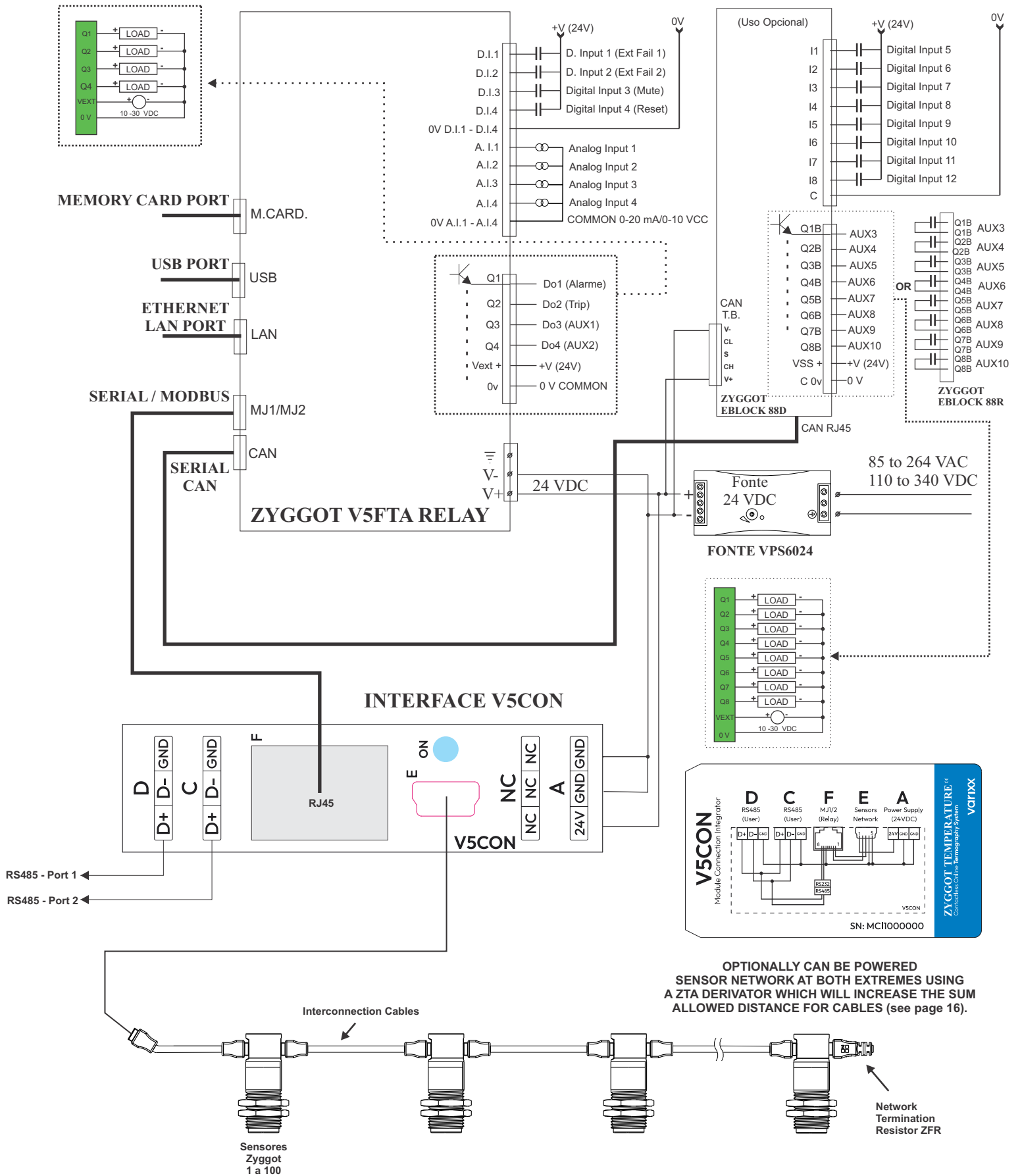

OPTIONALLY CAN BE POWERED SENSOR NETWORK AT BOTH EXTREMES USING A ZTA DERIVATOR WHICH WILL INCREASE THE SUM ALLOWED DISTANCE FOR CABLES (see page 16).

# CONNECTIONS (THM ONLY)

## External Fault Connection Usage Example

ZYGGOT THERMOGRAPHY  
CONTINUOUS TEMPERATURE MONITORING

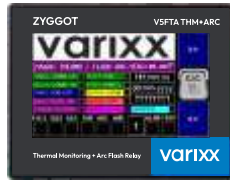

ARC FLASH ZYGGOT RELAY AND SENSORS



### USING NORMAL ZYGGOT V5F RELAY (NOT THM+ARC)

If the normal Zyggot relay (V5F) is used, the normal Zyggot arc relay can also be used connected to the V5F.

One or two Zyggot Arc relays can be connected to protect against electric arcs by detecting ultraviolet radiation, connected to the external fault input 1 and/or 2, for real-time historical purposes. Each Zyggot Arc Relay can monitor up to 50 sensors and, as one sensor is normally used per cubicle, up to 50 cubicles can be protected by each Zyggot arc relay.

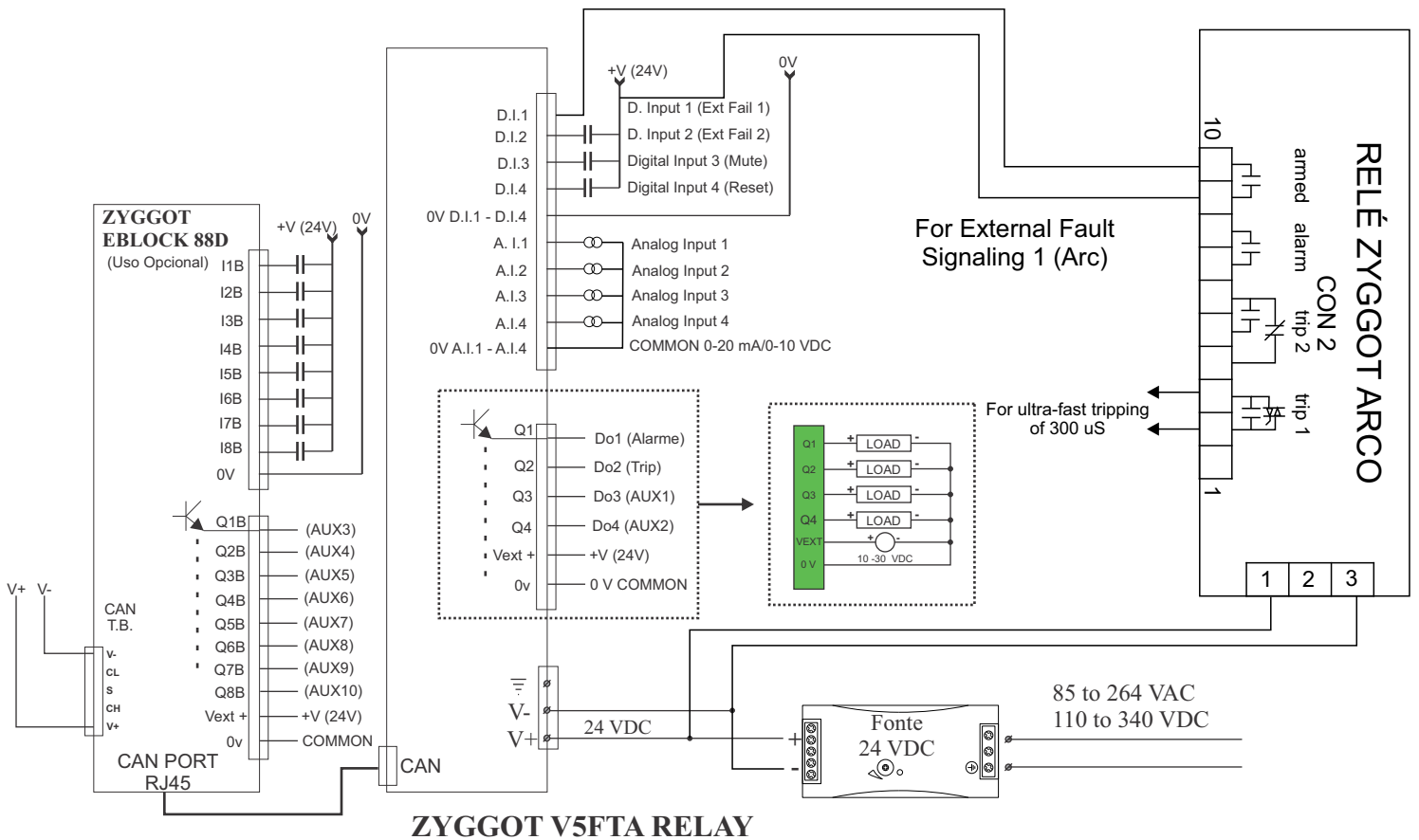

# TYPICAL INTERCONNECTIONS

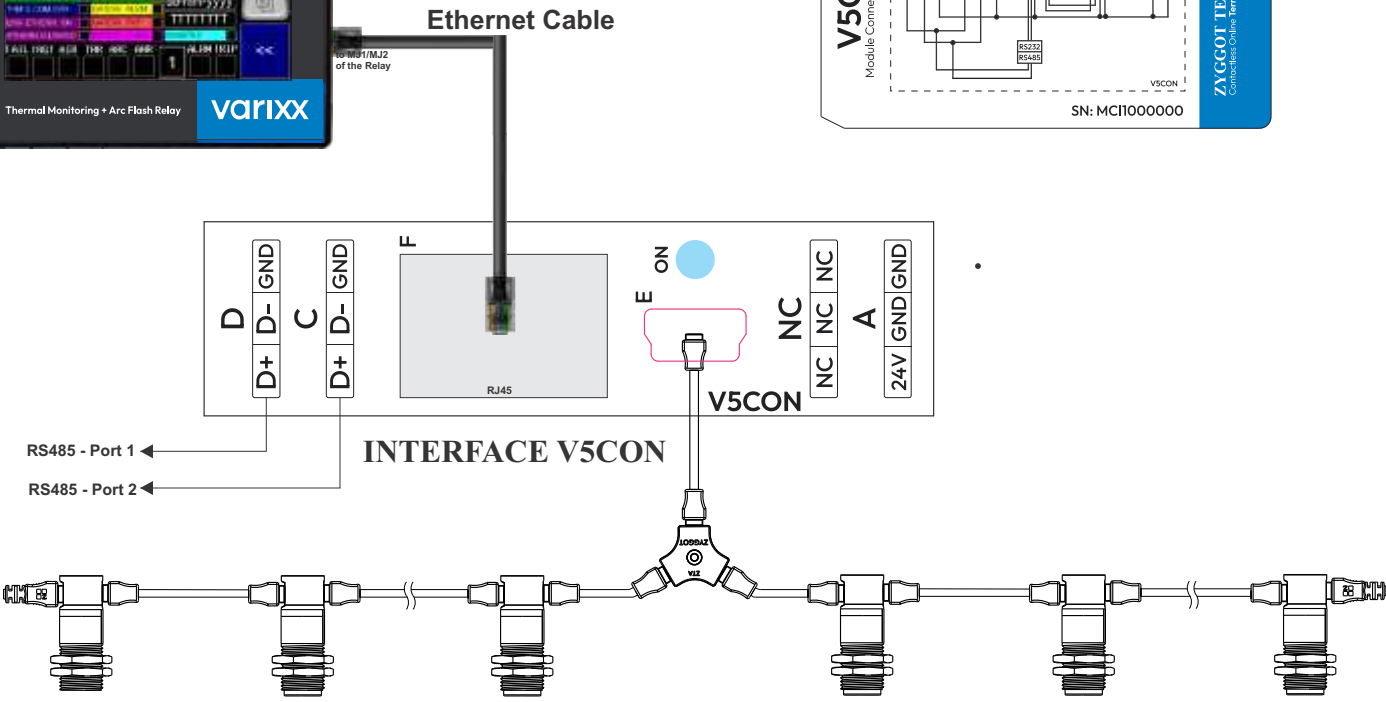
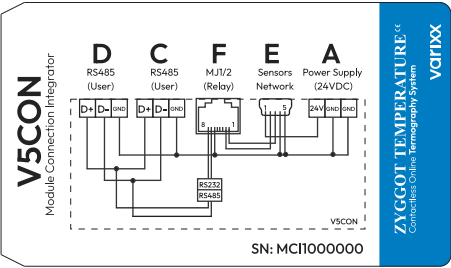

Note: The sum of the distances of the cables must not exceed 80 meters to Maximum 100 sensors or connect by both ends to double the distance (see example below).

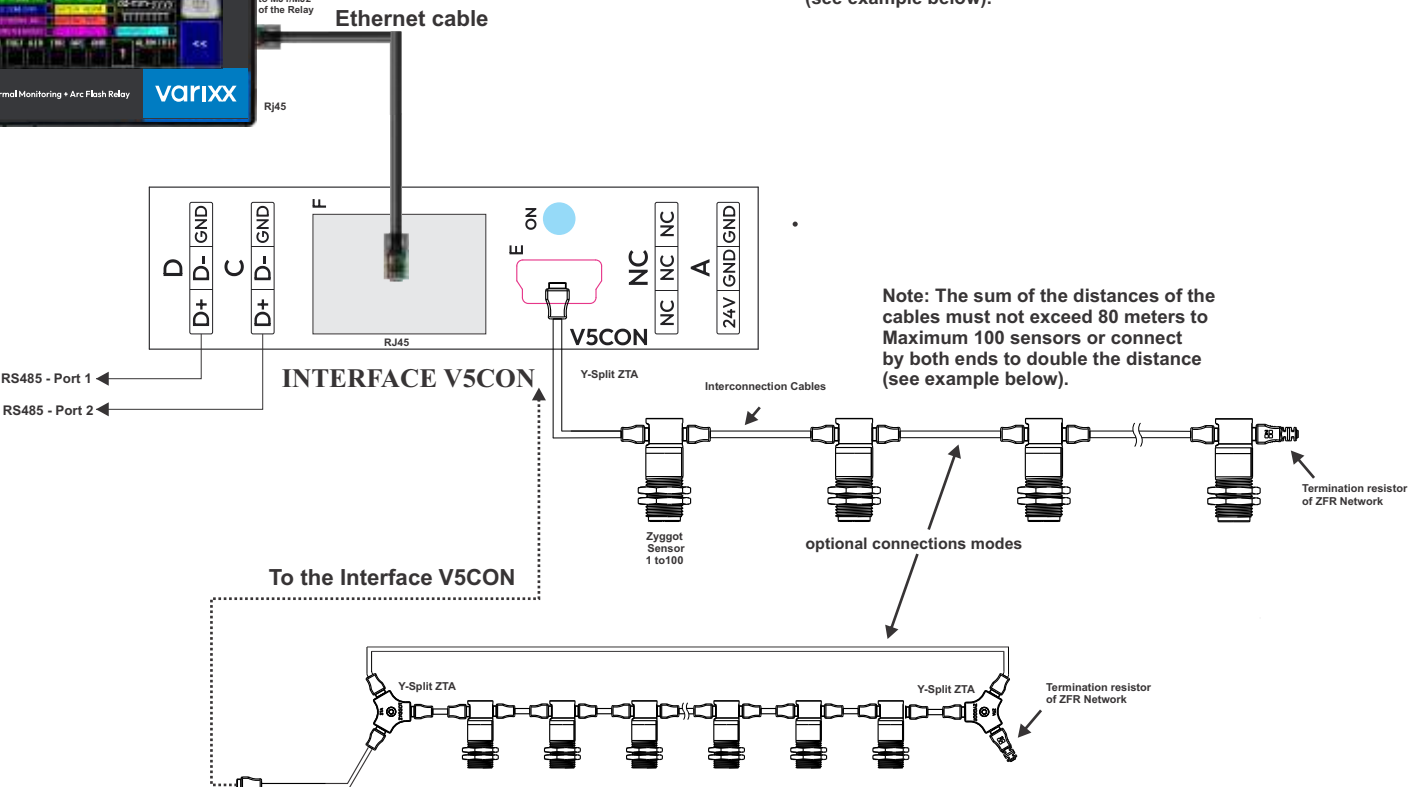

Note: The sum of the distances of the cables must not exceed 80 meters to Maximum 100 sensors or connect by both ends to double the distance (see example below).

Example of power supply/interconnection at both ends in order to increase the distance of the cables to twice what can normally be achieved.

# TYPICAL INTERCONNECTIONS (THM ONLY)

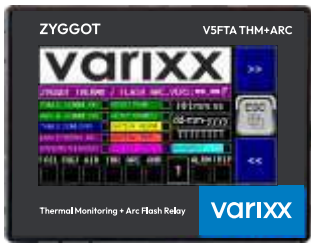

To MJ1/MJ2 of the Relay  
Ethernet Cable  
RJ45

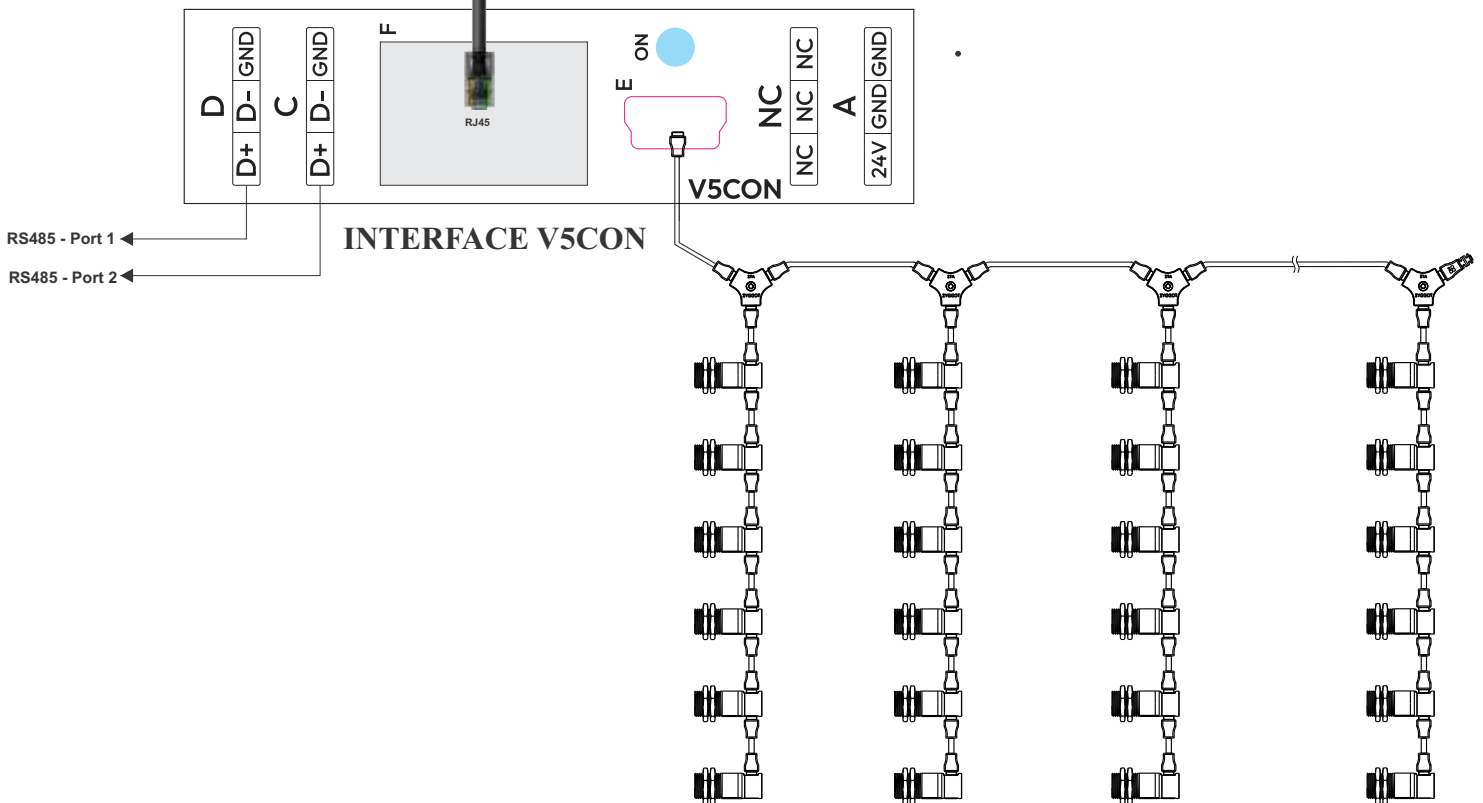
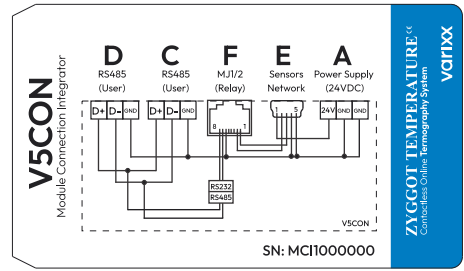

Note: The sum of the cable distances must not exceed 80 meters for a maximum of 100 sensors or supply/interconnect them at both ends using ZTA split to increase the distance (see example at page 16).

# MECHANICS



- 1- POWER 24 VCC
- 2- D.I. / A.I. CONNECTOR
- 3- D.O. / AQO. CONNECTOR
- 4- CAN PORT
- 5- RS232/RS485 SERIAL PORTS
- 6- CONFIGURATION SWITCHES
- 7- ETHERNET LAN PORT
- 8- MICRO SD SLOT
- 9- USB PORT

## Panel Cut Out



## EBLOCK 88R



- 1- DIGITAL DC OUTPUTS
- 2- NETWORK ID SELECTOR SWITCHES
- 3- STATUS LEDs
- 4- DIGITAL DC INPUTS
- 5- CAN and POWER
- 6- EARTH GROUND
- 7- CAN PORT - RJ45

EBLOCK 88D or EBLOCK 88R

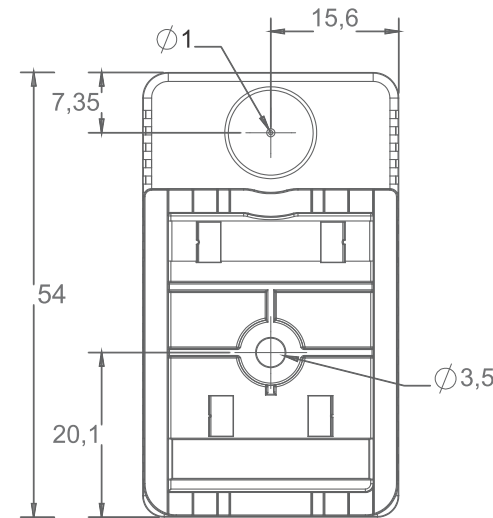
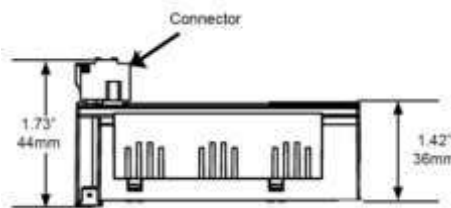
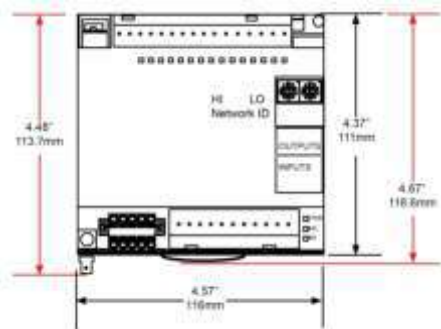

## Sensor BT

DIP SWITCHES			
PIN	NAME	FUNCTION	DEFAULT
1	RS-485 Termination	ON = Terminated	OFF
2	CAN Termination	ON = Terminated	OFF
3	Bootload	Always Off	OFF

DIP Switches at Relay

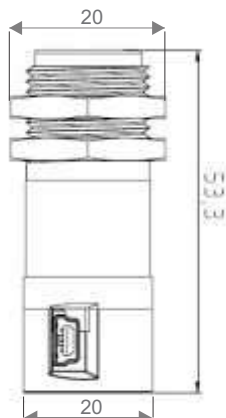

Tubular Sensor



Address Rotary Switches for CAN at Eblock 88x from 1 to 253 (decimal) or 01 to FD (Hexadecimal)

## CHARACTERISTICS RELAY V5F + EBLOCK 88x

Power Supply	24 Vcc, 150 mA
Moisture	5 to 95%
Dimensions Relay	96 mm x 125 mm x 31 mm
Dimensions Eblock	
Connections Relay	1 x RS232 1 x RS485 1 x CAN (125 Kbps - 1 Mbps) 1 x Ethernet (1-10 Mbps/100 Mbps) 1 x USB Mini Program 1 x USB Flash 1 x Micro SD/SDHC
Inputs Relay + Eblock	4 analogue 0-20 mA (50 ohms) 12 Bits, Error: 1,5% FS Max 4 + 8 digital 0-24 VDC Min On= 8VDC. Max Off: 3VDC
Outputs Relay + Eblock	4 + 8 (10 Programmable), Half-Bridge 0.5A max, 10 to 30 VDC, C. Source + Protection: Short and Overvoltage. or 8 Relay 3A @ 250 VAC Resist. Load
Communication Relay	Modbus RTU, CsCAN Ethernet, Devicenet (Optional)
Communication Eblock	CAN
Relay Screen	Color Screen, WVGA (480 x 272) Colors = 64K Resistive Touch Screen 4,3" 450 cd/m²
Certificates	CE / FCC Compliance - Part 15 of FCC
Connectors	3,5 mm - Pluggable
Weight	Relay: 270 g /// Eblock: 340 g
Temperature	Operation: -10°C to 60°C Stored: -30 °C to 70 °C
Battery RTC Relay	Operation: > 10 Years Stored: 5 to 10 years Clock Error: 8 s / month at 25 °C max

## RELAY VZX V5F:

- Ambient Operating Temperature: 0 to 45°C.
- Storage ambient temperature: -40 to 85°C.
- Relative Humidity: 5 to 95% N.C.
- NEMA Rating: NEMA 4X.
- Relay weight: 270 Grams.
- Dimensions: 125 x 96 x 31 mm.
- Noise immunity (EMC Immunity): EN61000-4-2 / EN61000-4-4 / EN61000-4-5 / EN61000-4-12 / ENV50140/50141
- Emissions: EN50081-2 / EN55022 / CISPR11. Class A.

## CAN NETWORK:

- 1: V+
- 2: CAN H
- 3: SHIELD
- 4: CAN L
- 5: V -

## CAN POWER RANGE:

12 to 25 VCC / 75 mA MAXIMUM.

## CONFIGURATION AND TESTING OF SENSORS

A sensor configuration program, free of charge, once installed on a PC, allows correctly configuring each sensor, before installing them in the panels or even after they are installed. The sensor can be reconfigured many times as necessary. More details in the chapter «Sensor Configuration» later in this manual.

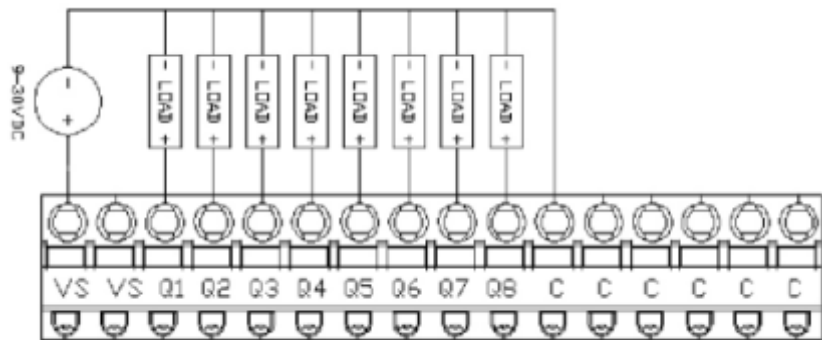

## EBLOCK EB/88D OUTPUTS

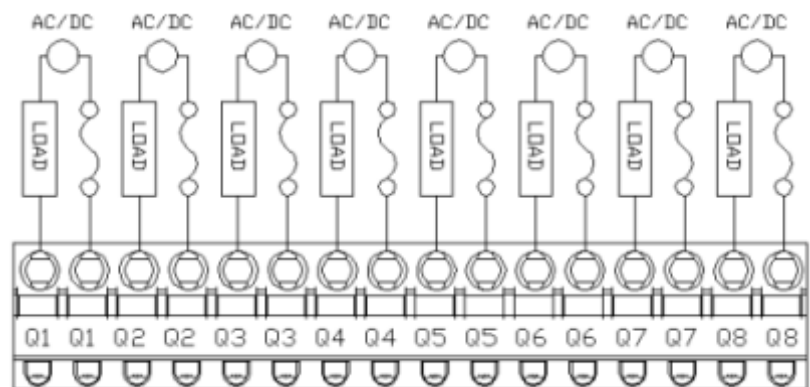

## EBLOCK EB/88R OUTPUTS

ONLINE THERMOGRAPHY WITHOUT CONTACT OF ACTIVE PARTS WITH THE BUS. THE TUBULAR SENSOR TYPE IS POSITIONED AT A DISTANCE, BEING INDICATED FOR MEDIUM AND HIGH VOLTAGE AND THE BT SENSOR IS FIXED ON THE BUS, BUT ONLY THE POLYCARBONATE PLASTIC BOX, RESISTANT TO 200 °C, STAY IN CONTACT. THE MEASUREMENT SENSOR IS NOT IN CONTACT, MEASURING ALSO BY IRRADIATED INFRARED. THE SENSORS ARE POWERED BY THE NETWORK CABLE.

# TECHNICAL SPECIFICATIONS - RELAY V5FTA

## POWER SUPPLY

Signal Pin	Description
V+	Input power supply voltage
V-	Input power supply ground
Gnd	Frame Ground

## GENERAL CHARACTERISTICS

- ! Graphical LCD Touch Screen w/ Backlight.
- ! 24 VDC
- ! RS-232 / RS-485 Serial Ports.
- ! Integrated Bezel.
- ! Real-Time Clock.
- ! Flash Memory for easy field upgrades.
- ! Ethernet LAN Port.
- ! USB port e Memory Card (to 32GB) available.

## CAN or CsCAN (OPT)

Peer-to-peer network. CAN-based network hardware is used in the controllers because of CAN's automatic error detection, ease of configuration, low-cost of design and implementation and ability to operate in harsh environments. Networking abilities are built-in to the control Module and require no external or additional modules.

## CAN Network Baudrate vs. Total Cable Length

Network Data Rate Maximum	Total Cable Length
1Mbit / sec.	40m (131 feet)
500Kbit / sec.	100m (328 feet)
250Kbit / sec.	200m (656 feet)
125Kbit / sec.	500m (1,640 feet)

## Mj1/ MJ2 PORT MODULAR JACK

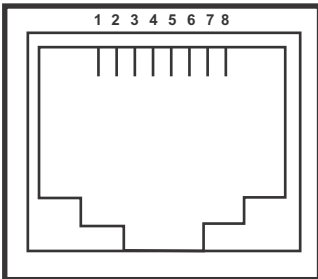

## MJ 1 PORT

PIN	SIGNAL
1	-
2	-
3	CTS
4	RTS
5	+5 V
6	0 V
7	RXD
8	TXD

Output Power Supply Max 150 mA

## Characteristics

Display Type (LCD Touch Screen):	64K Color Touch Screen
Display Size:	4,3"
Display Screen:	480 x 272 pixels
Touch Screen Type:	Resistive
Number of Colors:	64K
Power Current:	150mA @ 24VDC
Inrush Current:	(20A @ 24VDC) for 1ms.
Height:	96.0 mm)
Width:	125 mm)
Mounting Depth:	31 mm)
Weight	270 g)
Keypad Material:	Lexan HP92 by GE Plastics.
Protocols supported Serial Ports:	CsCAN, Modbus Master, Modbus Slave, and ASCII
Read and Write	
CAN Ports:	CsCAN (up to 253 drops)
Serial Ports:	2: RS-232 / RS-485 Ports.
Network Ports:	1: CAN (CsCAN peer)
Temperature & Humidity:	10 - 60°C,
5 to 95% Non-condensing	
CE	Compliant

## CAN PORT PINS

PIN	SIGNAL	DESCRIPTION
1	V-	POWER -
2	CN_L	SIGNAL -
3	NC	NC
4	CN_H	SIGNAL +
5	V+	POWER +

Note: To optimize CAN network reliability in electrically noisy environments, the CAN power supply needs to be isolated (dedicated) from the primary power. The CAN Shield must be attached to the panel as close to the Relay as possible.

## MJ 2 PORT

PIN	SIGNAL
1	RX+/TX+
2	RX-/TX-
3	-
4	-
5	+5 V
6	0 V
7	-
8	-

Output Power Supply Max 150 mA

# MAIN SCREENS FOR OPERATION

## a- MAIN MENU, (ESC) INFO SCREENS



### MAIN MENU:

Screen from which all other system screens are accessed. Depending on whether the system is configured for THM+ARC, THM only or ARC only, one of the 3 screens above will be accessed.

From here, all operating and programming screens are accessed.

Note that, to eventually draw the operator's attention, the «ALARM» field will flash and have a red border to indicate that there is an Acknowledged or Cleared alarm on the Alarm screen. By touching this field, you enter the alarm screen and can acknowledge and reset the alarm.

ATTENTION: THE ZYGGOT V5FTA RELAY LEAVES THE FACTORY WITH A PASSWORD TO ENTER THE PROGRAMMING MENU = «827499»  
CHANGE IT, WITHIN THE «RELAY CONFIG» MENU TO ANY OTHER VALUE (ADVISABLE).



### INFO SCREENS 1 to 5:

There are 5 screens, the one above, and the four below. They are paged through the >> and << keys and accessed through the ESC key on the main menu.

**INFO SCREEN 1:** Contains various information. When the system is powered on, this is the initial screen. Pressing ESC takes you to the main menu above.

**VERS:** Software version

**THM S.COMM OK:** Indicates that the THM sensor network is communicating OK.

**ARC S.COMM OK:** Indicates that the ARC sensor network is communicating OK.

**THM S.COMM ERR:** Indicates that the THM sensor network has a communication error.

**LINK ETHERN.OK:** Indicates that the Ethernet connection is OK.

**ETHERN.n. LINKED:** Indicates that the Ethernet connection is OK.

**GTWY PGM:** Indicates that the ARCO system Gateway is properly configured.

**GTWY ARMED:** Indicates that the ARC system Gateway has no active faults and is ready to "trip" in the event of an Arc or other faults.

**GATEW. ALRM:** Indicates that the ARC system Gateway is in an active Alarm condition (not reset).

**GATEW. TRIP:** Indicates that the ARC system Gateway is in an active Trip condition (not reset).

**GATEW. CHAIN:** Indicates that the ARC system Gateway has the Chain input active and a Chain trip has probably occurred (it depends on the Gateway configuration).

**INHIBITED:** Indicates that the ARC system Gateway has the INHIBIT input active and cannot trip even in the event of an ARC FLASH (it depends on the Gateway configuration).

**DATE, TIME and DAY OF THE WEEK:** from the internal real time clock.

**FAIL:** Indicates a fault that has not been reset.

**TRGT:** Indicates a fault related to Targets.

**AIR:** Indicates air-related fault (sensor bodies).

**TNR:** Indicates the existence of 1 or more THM sensors not responding on the network.

**ARC:** Indicates that there is an active arc occurrence (not reset).

**ANR:** Indicates the existence of 1 or more ARC sensors not responding on the network.

**ALRM:** Indicates the alarm condition not silenced (without Mute) and the alarm output active.

**TRIP:** Indicates the Trip failure condition (Trip output active, not reset)

# MAIN SCREENS FOR OPERATION

## a- MAIN MENU, (ESC) INFO SCREENS

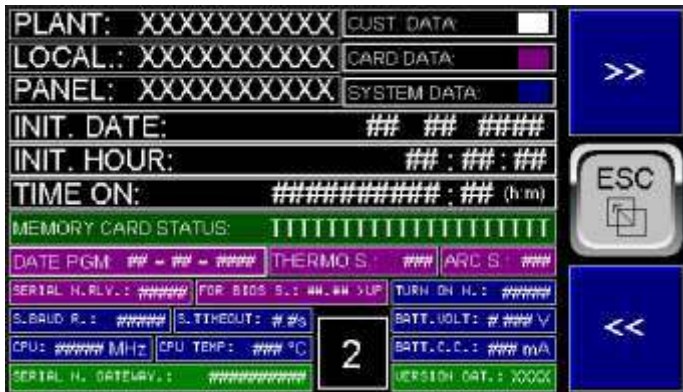

**INFO SCREEN 2:** It shows information about the plant, location and panel names, date and time of start of operation, total system operation time, relay serial number, software serial number, number of times the relay was turned on, baud rate and timeout of the sensor communication network, number of programmed sensors and finally it also shows some hardware information.

Other fields as described in Info Screen 1.



**INFO SCREEN 3: Mute Alarm and Reset Fail Buttons.**

When the alarm is active, the Mute button silences it (turns off the Alarm Output).

When the Mute condition is active (Mute has already been executed), the Reset button clears the fault and turns off the Trip Output.

**Fail Active:** Indicates that there is an active fault.

**Alarm Unacknowledged:** Indicates that there is an alarm that has not yet been acknowledged by the operator on the alarm screen and, depending on what is programmed in the **Reset on Fail Unacknowledge** parameter, it will not be possible to reset the faults and cancel the trip output.

**Alarm Uncleared:** Indicates that there is an alarm that has not yet been cleared by the operator on the alarm screen and, depending on what is programmed in the **Reset on Fail Active** parameter, it will not be possible to reset the faults and cancel the trip output.

Software interface and Autoload Fail indicate whether there was a restoration failure.

Other fields as described in Info Screen 1.



**INFO SCREEN 4:** «Fail Safe» system information such as Autoload Enabled, Autorun Enabled, Flash Backup Done (these 3 fields must be active, in green for the «Fail Safe» system to operate correctly if necessary). Flash Backup Cleared: It will indicate in yellow if there is no Backup file in the Flash memory. To create the backup file, enter the programming menu and create it after having all the parameters programmed and with the relay operating correctly.

Auto Restore Done, Indicates whether there was an automatic software restoration and Autoload Fail indicates whether there was a restoration failure.



**INFO SCREEN 5:**

On this screen, you can control the write and read protection on the memory card for safe removal and insertion of the card, with the relay in operation, preventing it from being manipulated during writing operations that could corrupt it.

**Remove/Insert:** This button is invisible if the relay is in writing or reading operation so that the Remove/Insert command is not entered at an inappropriate time.

**Wait:** If active, it indicates that the relay is in writing or reading operation.

**No Card:** It is active if the relay does not have a memory card inserted.

**Card OK:** Indicates that the card is inserted and operating properly.

**Ready to Remove/Insert:** After the Remove/Insert command is selected in the «Yes» option, this indication becomes active, indicating that the card can now be removed or inserted.

Memory Card Status: May display one of the following messages depending on the current system condition:

- 1- Card OK - Operational
- 2- Unknow Format
- 3- No card in slot
- 4- Card Not Supported
- 5- Illegal Swapped
- 6- Unknow Error
- 7- Access Protected

After the Insert/Remove command is selected as «Yes», the message will be 6- Access Protected.

**Attention:** Removing the card without the Insert/Remove command inserts the Alarm condition in the alarm and history screen if the action for this fault is selected as «Log» in the programming menu. If the action is selected as «None», this alarm will not be logged.

If the card is removed after the Insert/Remove command, the alarm will not be triggered even if programmed for «Log»

# MAIN SCREENS FOR OPERATION

## 1a- MAIN SCREEN

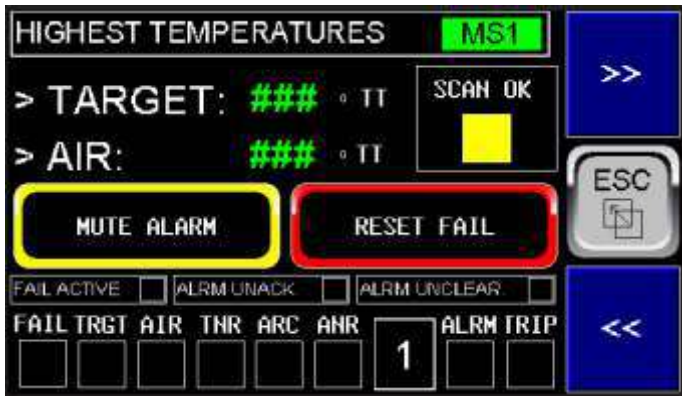

### MAIN SCREEN MS1 to MS12:

Ms1:  
 > **TARGET:** Shows the highest target temperature measured among all sensors.  
 > **AIR:** Shows the highest air/sensor body temperature measured among all sensors.  
 Fail Active: Indicates that there is an active failure.  
**Alarm Unacknowledged and Alarm Uncleared:** Indicate that there is an alarm acknowledged (Ack) and not cleared (cleared) respectively, still by the operator on the alarm screen and depending on what is programmed in the Reset on Fail Unack or Reset on fail Active parameters, it will not be possible to reset the failures and cancel the trip output.  
 SCAN OK: Indicates each Scan of all THM sensors.  
**MUTE ALARM:** As the name indicates, it silences an active alarm, that is, it turns off the alarm output that normally goes to an external Buzzer or other device.  
**RESET FAIL:** As the name indicates, it turns off active failures and turns off the Trip output that normally goes to an external device.  
 Other fields as described in Info Screen 1.

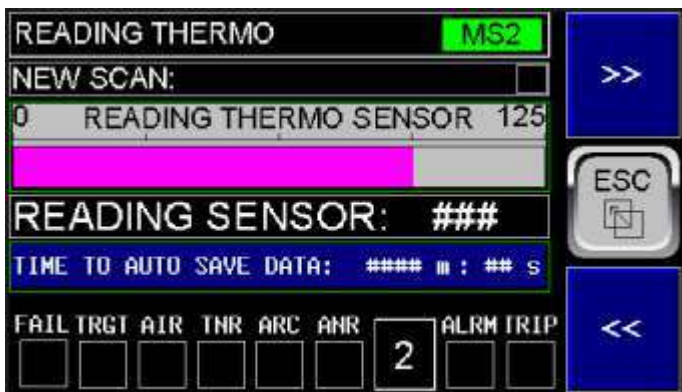

### MS2: READING THERMO

**NEW SCAN:** Indicates new reading scan of THM sensors in the network. This is done continuously.  
**READING SENSOR:** Shows the number of the sensor being read and a bar graph corresponding to the number of the sensor currently being read. It serves to show activity and generate confidence that the sensors are being read continuously. It also shows the time remaining for new saving of target and air temperature data for all sensors if programmed to perform this action. If not programmed, it will always show zero.  
**TIME TO AUTO SAVE DATA:** Shows the time for automatic data saving, depending on the programming in the corresponding parameters.  
 Other fields as described in Info Screen 1.

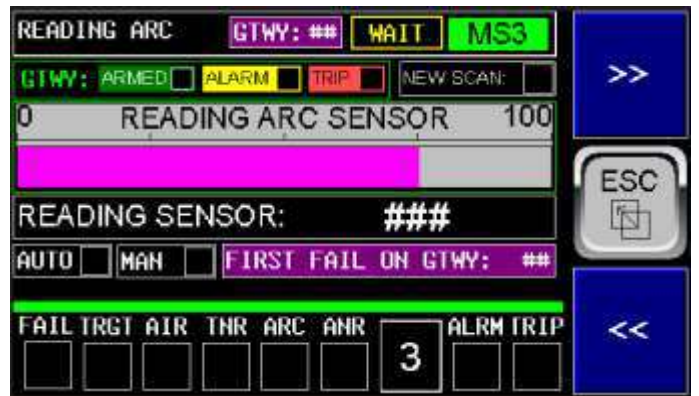

### MS3: READING ARC GATEWAY (Mono and Multi-Gateways Version Screens)

**GTWY:** Shows the number of the gateway currently being read  
**READING SENSOR:** Bargraph with the number of the sensor read.  
**AUTO and MAN:** Indicates the gateway scanning condition.  
**FIRST FAIL ON GTWY:** Shows which gateway detected the first failure.  
**ARMED, ALARM, TRIP:** Indicates the conditions of at least one of the system gateways. If all Gateways are OK, there will be no ALARM or TRIP indication and there will be an ARMED indication.  
 Other indications: as described in INFO SCREEN 01.



### MS4: STATISC THERMO

**PROGRAMMED:** Shows the total number of THM sensors in the network.  
**RESPONDING:** Shows the number of THM sensors responding in the network.  
**NOT RESPONDING:** Shows the number of THM sensors not responding in the network.  
**TOTAL ALARMS:** Shows the total number of alarms in the system, both THM and ARC, that have occurred since the last action to reset this number from the programming menu.  
**TOTAL TRIPS:** Same as number of trips that have occurred.  
**WAIT:** Indicates that the readings are not yet reliable until a new Scan is completed.  
 Other fields as described in Info Screen 1.

# MAIN SCREENS FOR OPERATION

## 1b- MAIN SCREEN



**MS5: STATISTIC ARC (Multi and Mono Gateway versions screens)**  
**PROGRAMMED:** Shows the total number of ARC sensors in the network.  
**RESPONDING:** Shows the number of ARC sensors responding in the network.  
**TOTAL SENSORS NOT RESPONDING:** Shows the number of ARC sensors not responding in the network.  
**TOTAL ARC FLASH NOT CLEARED:** Shows the total number of sensors that detected Arc Flash in all gateways and that are still memorized in the gateways before the reset command, which will clear the events from the gateways.  
**FIRST SENSOR WITH ARC FLASH:** Indicates the number of the first sensor to detect Arc Flash (only in the mono gateway version)  
 Other indications: as described in INFO SCREEN 01.



**MS6:**  
**DIGITAL INP.1 a 4:** Indicates the status of the digital inputs of the V5FTA relay.  
**DIGITAL OUT 1 to 4:** Indicates the status of the digital outputs of the V5FTA relay



**MS7: DIGITAL I/O and BLOCK / ARC GATEWAY**  
**Digital Input EB1 (Aux 1) to EB8 (Aux 8):** Indicates the status of the digital inputs of the EBLOCK module, if used.  
**Digital Output EB1 (Aux 1) to EB8 (Aux 8):** Indicates the status of the digital outputs of the EBLOCK module, if used.  
 Other fields as described in Info Screen 1.

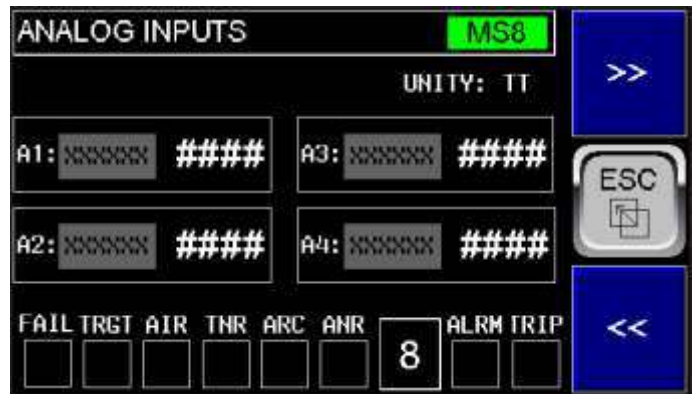

**MS8: ANALOG INPUTS**  
**ANALOG INP.1 to 4:** Shows the values of Analog inputs 1 to 4 if used. It also shows the name assigned by the user to each input to facilitate identification.  
 Other fields as described in Info Screen 1.



**MS9: THERMO SENSOR COMMUNICATION**  
**SENSOR COMM OK:** THM sensor communication status.  
**S. COMM ERROR:** Indicates a communication error in the THM sensor network.  
**TIMEOUT:** Indicates whether there is a Timeout error with the sensors.  
**FRAME/PARITY:** Indicates if there is a Frame or Parity error.  
**RESP FORM:** Indicates if there is an error due to an unexpected response.  
**ADDR REJECTION:** Indicates whether there is an error due to address rejection in the THM sensor network.  
**REJECTION COMM.:** Indicates whether there is an error due to communication rejection in the THM sensor network.  
 Other indications: as described in the INFO SCREEN 01 screen

# MAIN SCREENS FOR OPERATION

## 1c- MAIN SCREEN



### MS10: ARC SENSOR COMMUNICATION.

**SENSOR COMM OK:** Indicates whether communication with the Gateway is OK.

**S. COMM ERROR:** Indicates whether there is a communication error with the Gateway.

**TIMEOUT:** Indicates whether there is a Timeout error with the Gateway.

**FRAME/PARITY:** Indicates whether there is a Frame or Parity error.

**RESP FORM:** Indicates whether there is an error due to an unexpected response.

**ADDR REJECTION:** Indicates whether there is an error due to address rejection in the THM sensor network.

**S. COMM ERROR:** All sensor not responding. Communication error.

**Frame/Parity:** Error of Frame/Parity parameter.

**CRC /CHECKSUM:** Cyclic Redundance Test or Checksum error.

**COMM REJECTION:** Indicates whether there is an error due to communication rejection in the THM sensor network.

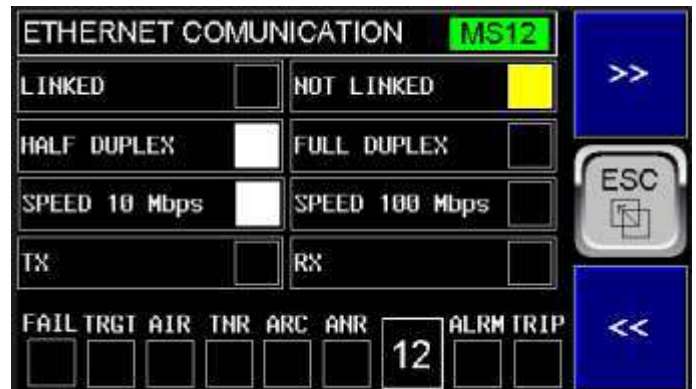

### MS12: ETHERNET COMMUNICATION

**LINKED:** Indicates that the Ethernet cable is connected.

**NOT LINKED:** Indicates that the Ethernet cable is disconnected.

**HALF DUPLEX and FULL DUPLEX:** Indicates the current communication mode.

**SPEED 10 Mbps and SPEED 100 Mbps:** Indicates the current communication speed.

**RX:** Indicates that data is being received.

**TX:** Indicates that data is being transmitted.

Other fields as described in Info Screen 1.



### MS11: MODBUS SERIAL RS232

**MODB ACTIVE:** Indicates whether MODBUS is active.

**MODBUS INACTIVE:** Indicates whether MODBUS is inactive.

**MODBUS OK:** Indicates whether MODBUS is OK, without error.

**MODBUS ERROR:** Indicates if there is an error in Modbus.

**MODBUS STATUS:** (TIMEOUT, VALID MESSAGE, PARITY ERROR, FRAME ERROR, OVERRUN ERROR, CHECKSUM ERROR)

Other fields as described in Info Screen 1.



### MS13: ACTIVE FAILS

Active Fails (Not memorized and still in fault condition at the moment).

**TARGET ALARM:** Indicates if there is any THM target in alarm condition.

**TARGET TRIP:** Indicates if there is any THM target in Trip condition.

**AIR ALARM:** Indicates if there is any THM air (body) in alarm condition.

**AIR TRIP:** Indicates if there is any THM air (body) in Trip condition.

**DIFF ALRM:** Indicates if there is any target in differential alarm condition.

**THM COMM. FAIL:** Indicates if there is a communication failure with the THM network.

**MODBUS FAIL:** Indicates a communication failure with the external device connected to the relay's Modbus network.

**THM S. NOT RESP:** Indicates a Not Responding failure in the THM sensor network.

**DIFFERENTIAL:** Indicates if there is any target in differential Trip condition, if programmed to use this condition.

**AIR ALARM:** Indicates if there is any THM sensor with AIR (Body) temperature higher than the level programmed for Alarm

**AIR TRIP:** Indicates if there is any THM sensor with AIR (Body) temperature higher than the level programmed for Trip.

**ARC FLASH:** Indicates if there is an ARC FLASH occurrence not reset on the Gateway.

**GTWY COMM. FAIL:** Indicates communication failure with the Gateway.

**ARC S. NOT RESP:** Indicates if there is one or more Arc sensors not responding (note that this is different from a general communication failure with the Gateway).

**ARC CHAIN:** If programmed to be used, indicates Trip by CHAIN input on the Gateway.

**GTWY NOT PROG:** Indicates that the Gateway has not been configured correctly yet.

Other fields as described in Info Screen 1.

# MAIN SCREENS FOR OPERATION

## 1d- MAIN SCREEN



### MS14: MUTE / RESET

**MUTE ALARM / RESET FAIL:** Buttons that allow you to silence (Mute Alarm) the alarm or reset (Reset Fail) the fault condition. Reset Fail will only act if it is already silenced (Mute) and if 'Reset on Fail' is programmed if there is still an existing fault.

Other fields as described in Info Screen 1.



### MS16: GATEWAY SCAN (Only in the Multi-Gateways Version)

Allows you to select between Automatic or Manual Scan for the gateways connected to the relay, if more than one is used.

**AUTO:** When pressed, it will select the «Automatic» mode.

**MAN:** When pressed, it will select the «Manual» mode.

**Time to Return to Auto:** Indicates the countdown time from 600 to 0 seconds to return to automatic mode. Manual mode allows the operator to quickly check the conditions, status and readings of arc occurrence and arc sequence in a given gateway of the system. Note that in Automatic mode, if a fault is detected in any gateway, the Scan may stop or continue depending on what was selected in the parameters. If selected to continue, the fault indication in each gateway is shown on the Gateway Status screens and in this case the operator can manually select the appropriate gateway to check the detected faults and other readings related to that gateway. Note that the occurrence of the trip related to any gateway does not depend on the relay readings but has already been performed by the triggering gateway in less than 250 µs. [Displayed only if in «Manual»]

**Gateway:** This key must be used to enter the number of the Gateway to be monitored in the Manual Scan condition. Displayed only if in «Manual».]

**First Fails On Gateway:** Displays the number of the Gateway that detected the first failure.

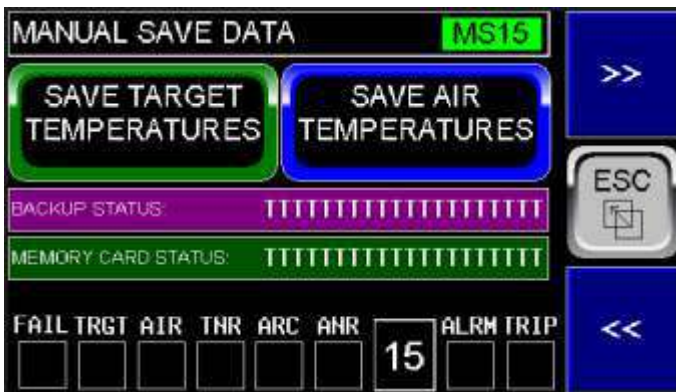

### MS15: MANUAL SAVE DATA (THM)

On this screen, you can save the target and air temperature data from all sensors to the memory card, by manual command, at any time.

These files are in Excel CSV format with data separated by commas and can be opened in Excel and generated into tables or graphs.

**SAVE TARGET TEMPERATURES:** When pressed, it turns green while the target temperature data is added to the corresponding file on the memory card.

This file is located in the **DATAMAN** directory and in the **TRGTDATA** file and the data is added to the existing data in the following sequence: dd, mm, yyyy, hh, mm, ss, 0, NS, SR, 0, T1, T2, T3,.....Tn. (zero serves as a separator).

**SAVE AIR TEMPERATURES:** When pressed, it turns green while the air temperature data is added to the corresponding file on the memory card. This file is located in the **DATAMAN** directory and in the **AIRDATA** file and the data is added to the existing data in the following sequence: dd, mm, yyyy, hh, mm, ss, NS, SR, 0, T1, T2, T3,.....Tn. (zero is used as a separator).

The above buttons are invisible if the moment is not suitable for saving data, for example if another instance of writing or reading the card is in progress.

**MEMORY CARD STATUS:** displays one of the statements as described in Info Screen 4 above.

**BACKUP STATUS:** Displays one of the following statements depending on the current status:

1- STANDBY / 2- OK - PROCEED / 3- ERROR - CHECK CARD / 4- DONT BACKUP ON FAIL / 5- OK - DONE / 6- WRITING / 7- READING / 8- BUSY.

In the example below, target temperatures, with 10 sensors, 10 responding. The same applies to the **AIRDATA** file.

# MAIN SCREENS FOR OPERATION

## 2-TARGET, 3- AIR, 4- SELECTED



### TARGET T01 to T17:

There are 17 screens, scrolled by the >> and << keys.  
**T01 to T21:** Screen Index. Flashes if any of the Target values is above the set alarm value.  
 °TT: Indicates °C (degrees Centigrade) or °F (degrees Fahrenheit), as programmed.  
**T001 to T100** (screens 1 to 17): Shows the current temperature of each target. The color will be white if within the normal range, yellow if above the programmed Alarm point and red if above the programmed Trip point. If yellow or red, it will also flash.



### AIR T01 to T17:

There are 17 screens scrolled by the >> and << keys  
**A01 to A17:** Screen Index. Flashes if any of the Air (Sensor Body) values are above the stipulated alarm value.  
 °TT: Indicates °C (degrees Centigrade) or °F (degrees Fahrenheit), as programmed.  
**A001 to A100** (from screens 1 to 21): Shows the current temperature of each target. The color will be white if within the normal range, yellow if above the programmed Alarm point and red if above the programmed Trip point. If yellow or red, it will also flash.



### SELECT TARGET ST01 to ST4: SELECT AIR SA1 to SA4:

There are 8 screens, scrolled by the >> and << keys.

**St01 to ST4:** Screen Index. Flashes if any of the Target values, even if not selected, is above the stipulated alarm value.  
**T###:** Sensor index, from 1 to 100, which the operator can enter by touching this key to monitor the Target Temperature. Flashes if this temperature is above the alarm level programmed for it.  
**####:** Shows the current temperature of the selected target. The color will be white if within the normal range, yellow if above the programmed Alarm point and red if above the programmed Trip point. If yellow or red, it will also flash.  
**Sa01 to SA4:** Screen Index. Flashes if any of the Air (Body) values, even if not selected, is above the stipulated alarm value.  
**A###:** Sensor index, from 1 to 100, which the operator can enter by touching this key to monitor the Air (Body) Temperature. It flashes if this temperature is above the alarm level programmed for it.  
**####:** Shows the current temperature of the selected air. The color will be white if within the normal range, yellow if above the programmed Alarm point and red if above the programmed Trip point. If yellow or red, it will also flash.  
 °TT: Indicates °C (degrees Centigrade) or °F (degrees Fahrenheit), as programmed.

# MAIN SCREENS FOR OPERATION

## 5-FAILS



### FAILS AF1 to AF8:

There are 8 screens scrolled by the >> and << keys.

They indicate the memorized faults (active or not at the moment) if selected in the programming menu for LOG, ALARM or TRIP. They are self-explanatory.

The Mute Alarm and Reset Fail buttons on each screen allow you to silence the alarm (digital alarm output) or Reset the fault, respectively. Note that to reset the fault you must first perform the Mute and also that the fault no longer exists if the 'Reset On Fail' parameter is not enabled in the Programming menu.

They also show the conditions: Alarm State Active and Trip State Output.

Fail Active, Alarm Unacknowledged and Alarm Uncleared: as detailed in screen Ms1.

# MAIN SCREENS FOR OPERATION

## 6a- TRENDSINGS (THM)

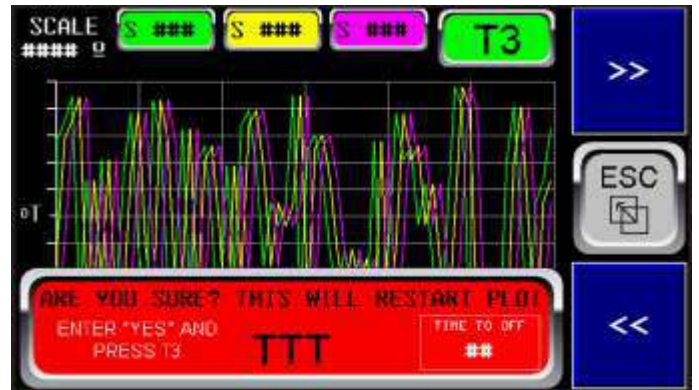
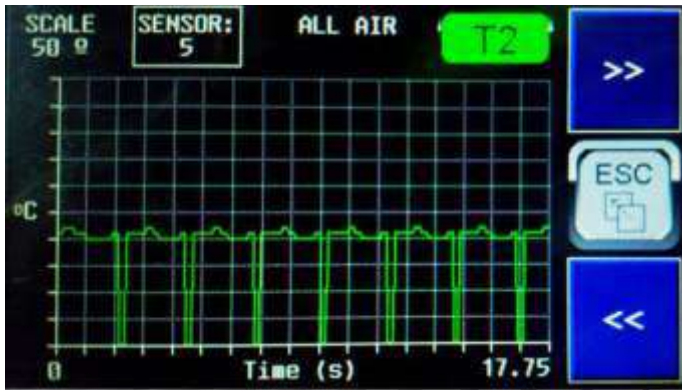
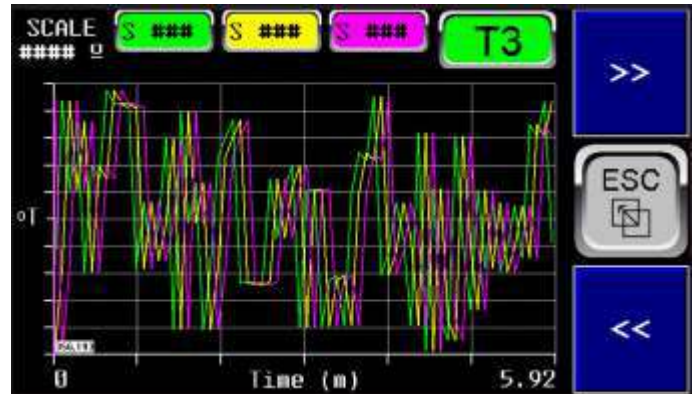
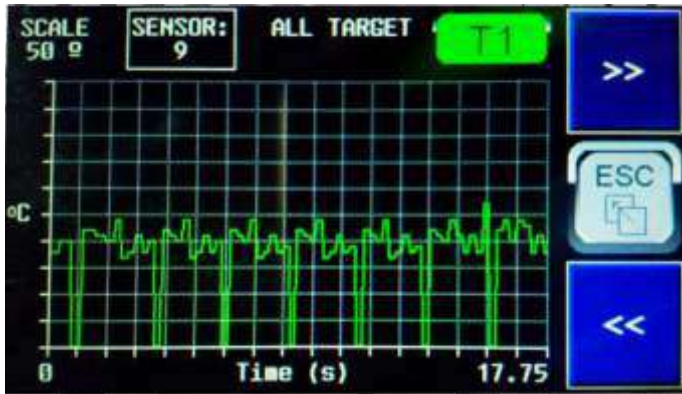

### TRENDING PLOT T1 and T2 (Continuous Scope):

There are 18 screens, scrolled by the >> and << keys. These are the first two.  
 T1 and T2: Screen Index and curve reset button (Plot restart) if programmed to be active in the programming menu.  
 The first two show all the Target and Air temperatures respectively, of the sensors programmed in the network. With each 'scan' of all the temperatures, the curve goes down to zero and repeats this continuously as if it were an electrocardiogram. The 'scan' never stops and the curve is continuously shifted to the left.  
 The sampling time is 50 ms and each screen can show 17.75 seconds. When leaving this screen and returning to it, the curves restart, unlike the curves from T4 to T18.

### TRENDINGPLOT T3 (Continuous Scope):

This is the third screen of the 18 plot screens, scrolled by the >> and << keys.  
 T3: Screen Index and curve reset button (Plot restart) if programmed to be active in the programming menu.  
 On this screen, you can enter the indexes of 3 sensors, from 1 to 100, and if you enter «0» (Zero), the trace remains at zero. With each 'scan', the curve goes down to zero and repeats this continuously as if it were an electrocardiogram. The «scan» never stops and the curve is continually shifted to the left.  
 The sampling time is 1000 ms, and each screen can show 5.92 minutes in total. When you leave this screen and return to it, the curves restart, unlike the curves from T4 to T18.  
 When you press the T3 key, the button appears in red, asking if you are sure you want to restart the curves on this screen. If yes, the operator will have 10 seconds to enter the answer "Yes" on the button and touch T3 again. Otherwise, the red button disappears and the curves are not reset.

# MAIN SCREENS FOR OPERATION

## 6b- TRENDSINGS (THM)

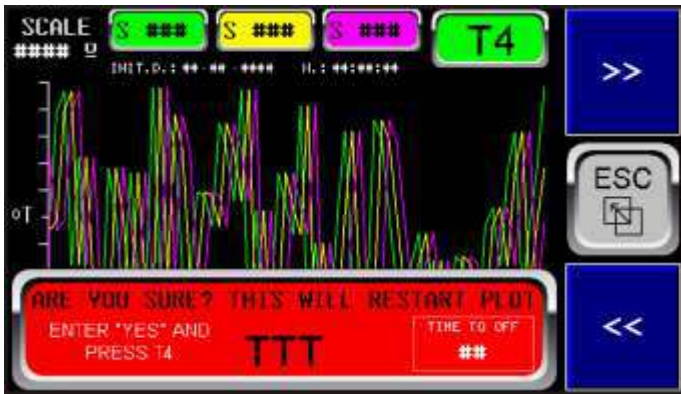
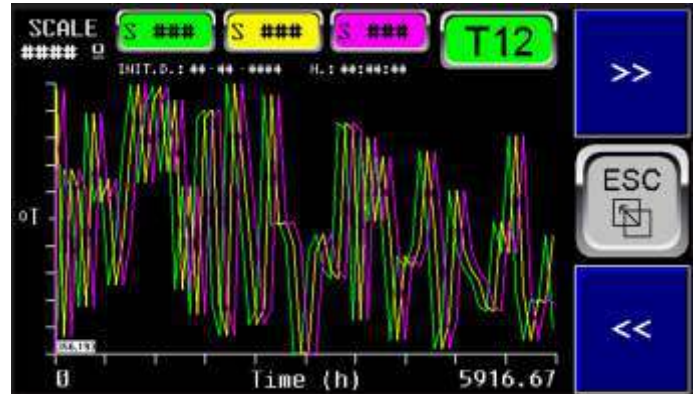
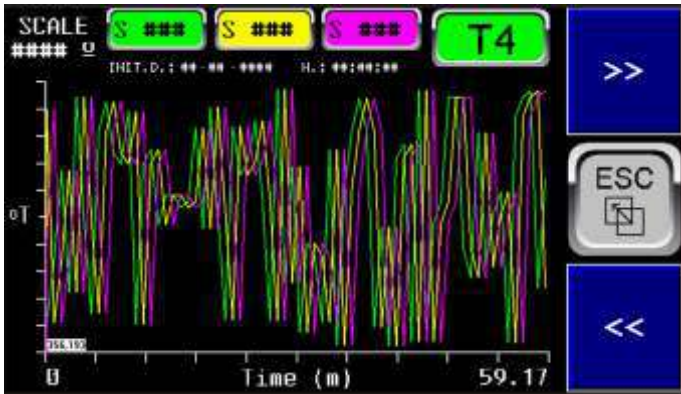

TRENDING PLOT T4 to T12 (Trending Plot):

These are screens 4 to 12 of the 18 screens paged by the >> and << keys.

T4 to T12: Screen Index and curve reset button (Plot restart) if programmed to be active in the programming menu.

Screens T4 to T12 show 3 sensors each, selected on the screen itself using the S keys (or in the programming menu) and each screen has different reading time bases (See Table). These Screens do not restart the reading automatically when exiting them, they are functional even if they are not displayed and show the curves when you vote for them.

However, when the screen is finished, the plot does not remain inactive but always shows the memorized traces even if the relay is turned off and on again.

The date and time of the start of the plot is shown in the upper part of each screen independently of the others.

To restart, touch the buttons T4 to T12.

When pressing keys T4 to T12, a red button appears, asking if you are sure you want to reset the curves on this screen. If so, the operator will have 10 seconds to enter the answer "Yes" on the button and touch T4 to T12 again. Otherwise, the red button disappears and the curves are not reset.

If the red button is counting down from 10 seconds and you exit the screen, it will also be automatically extinguished.

Screen	Sampling Time	Screen Cycle
1 e 2	50 ms	17,75 s
3 e 8	1000 ms	5,92 m
4 e 9	10 s	59,17 m
5 e 10	100 s	591,67 m
6 e 11	1000 s	5916,67 m
7 e 12	1000 m	5916,67 h
13	50 ms	17,75 s
14	1 s	355 s
15	10 s	59,17 m
16	100 m	591,67 h
17	1000 m	5916,67 h
18	10 s	59,17 m

# MAIN SCREENS FOR OPERATION

## 6c- TRENDSINGS (THM)

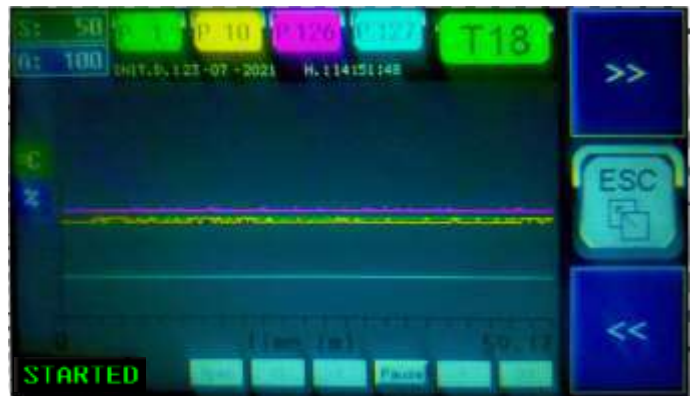
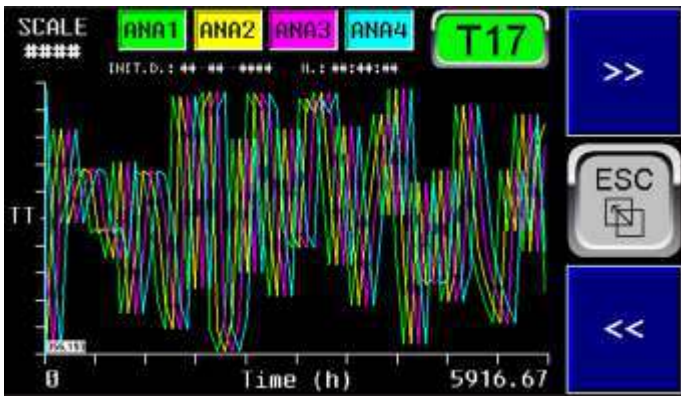

### TRENDING PLOT T13 to T17 (Trending Plot):

These are screens 13 to 17 of the 18 screens paged by the >> and << keys.

**T13 to T17:** Screen Index and curve Reset button (Plot restart) if programmed to be active in the programming menu. Screens T13 to T17 show 4 curves each, corresponding to the 4 analog inputs, with different sampling times (See Table). The X axis shows whether the scale is in temperature (°C or °F) or percentage (%) and the scale value is shown in the upper left.

These screens do not automatically restart the reading when exiting them, they are functional even if they are not displayed and show the curves when voting on them. However, when the screen is finished, the plot does not remain inactive but always shows the memorized lines even if the relay is turned off and on again.

The date and time of the start of the plot is shown in each screen independently of the others.

If the relay is turned off and on again, the previous sampling is not lost and the new sampling is separated by a vertical black line.

To restart, touch buttons T13 to T17.

When pressing keys T13 to T17, a red button appears, asking if you are sure you want to restart the curves on this screen. If so, the operator will have 10 seconds to enter the answer "Yes" in the button and touch T13 to T17 again. Otherwise, the red button disappears and the curves are not reset.

If the red button is counting down for 10 seconds and you leave the screen, it will also be automatically extinguished.

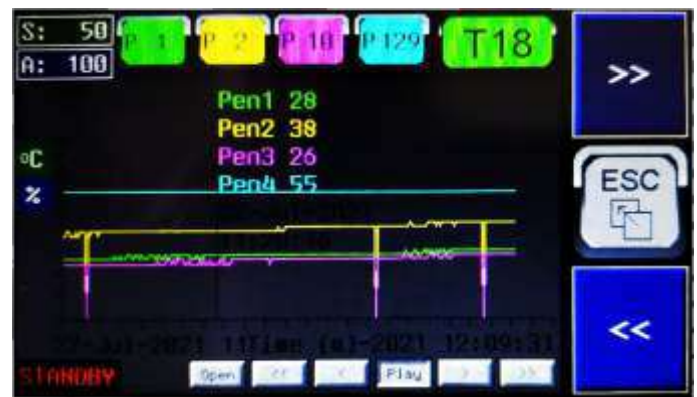

### TRENDING PLOT T18 (Retentive Trending Plot):

This is screen 18 of the 18 screens that are paged by the >> and << keys.

This feature allows the recording of the curves and data plotted on it on the memory card of up to 32 Gb inserted in the appropriate slot in the relay.

When initialized in the programming menu, the screen will display in the lower left corner the information in green letters «STARTED» and a file folder will be automatically created on the card with the name **Plotzxx** where xx is the end of the current node. If it is not started, the message will be «STANDBY».

When in «Started», every hour a new file with the csv extension will be created within this file, with the name consisting of the day, month and full hour, without the minutes. Each file contains data separated by commas, which can be opened in Excel using the «Get data» function in the «Data» tab and graphs can be generated. Each file is automatically saved every hour and will contain 360 readings of each of the 4 variables (4 traces). Each reading is taken every 10 seconds. They are light files of approximately 18 Kb each. Even if you exit the screen, the recordings continue and if the recording is interrupted by turning the power off and on again, a vertical black line appears at this point and the recording continues.

On the screen, you can directly enter the plotted variables read and recorded, one on each upper button with the colors corresponding to the trace. You can enter from 1 to 100, corresponding to targets 1 to 100 sensors or from 126 to 129 corresponding to analog inputs 1 to 4 (101 = A1, 102 = A2, 103 = A3 and 104 = 4). If you enter 0 «zero», the trace will remain zeroed all the time. In the upper left corner the two scales are shown, for target temperatures of the sensors in Green and analog inputs in Blue.

# MAIN SCREENS FOR OPERATION

## 6d- TRENDS (THM)

The top left corner shows the two scales, for sensor target temperatures in green and analog inputs in blue.

The two corresponding units are shown on the vertical Y axis, with °C in green for sensors and % or ° for analog inputs, depending on what is programmed in the programming menu for them.

The screen index (T18) is located in the top right corner. This button does not allow for resetting or restarting the curve and, if pressed, indicates with a sentence to enter the programming menu, turn this feature off and on again to restart the curves. This is done for safety reasons so that the memorization is not inadvertently lost.

The recorded curves can also be redone on the screen by the relay itself, for examination. While they are being re-displayed, the user can move their finger on the screen and move the cursor (a vertical black line). Then, for each point, the index of each line and the corresponding value are displayed, with the corresponding colors corresponding to the lines, in addition to the date and time of recording.

At the bottom are the playback control keys, namely:

«Pause» or «Play» If it is showing «Pause», the operation is effectively in Play and the curves are being generated and plotted in real time. When pressed, it changes to «Play» and the operation is effectively in Pause and the curves shown are previously recorded, obtained from the memory card. In other words, the button actually shows the state that will be entered when pressed.

«<<» This button allows you to search for the first recorded curve of the file within the date and time range selected in the Open button.

«>>» Same as above. This button allows you to search for the last recorded curve of the file.

«<» and «>» same as above, allow you to search one by one in the sequence for the sequential recorded curves. «Open» button that allows you to select a time interval for the curves to be retrieved, by date and time, by entering the start date and time and end date and time of the period of interest in the window that opens, to restrict the number of curves to be paged through using the search keys above and to make their location easier.

Below we see an example of the structure of Plot files on the card.



Nome	Data de modificação	Tipo	Tamanho
081809.CSV	18/08/2021 09:55	Arquivo de Valo...	11 KB
081213.CSV	12/08/2021 13:57	Arquivo de Valo...	16 KB
081212.CSV	12/08/2021 12:59	Arquivo de Valo...	18 KB
081211.CSV	12/08/2021 11:59	Arquivo de Valo...	18 KB
081210.CSV	12/08/2021 10:59	Arquivo de Valo...	16 KB
081209.CSV	12/08/2021 09:50	Arquivo de Valo...	14 KB

	A
1	Date,Time,Pen1,Pen2,Pen3,Pen4
2	19-08-2021,10:00:03 AM,000052,000056,000000,000000
3	19-08-2021,10:00:13 AM,000052,000056,000000,000000
4	19-08-2021,10:00:23 AM,000052,000056,000000,000000
5	19-08-2021,10:00:33 AM,000052,000056,000000,000000
6	19-08-2021,10:00:43 AM,000052,000056,000000,000000
7	19-08-2021,10:00:53 AM,000052,000056,000000,000000
8	19-08-2021,10:01:03 AM,000052,000056,000000,000000
9	19-08-2021,10:01:13 AM,000052,000056,000000,000000
10	19-08-2021,10:01:23 AM,000052,000056,000000,000000
11	19-08-2021,10:01:33 AM,000052,000056,000000,000000

# MAIN SCREENS FOR OPERATION

## 7- IDENTIFY / TEST SENSORS



### ON OFF FLASH SENSOR SCREEN THM and ARC:

There are two screens where you can control the change in the pattern between continuous on and flashing of the LED on the back of each sensor to facilitate its identification in the network and also to check communication with it.

In the current system configuration, each sensor has an LED on the back that flashes continuously in the case of the THM network or remains constantly on in the case of the ARC network, while it is active and communicating with the relay.

Although it is identified as Flash, in the current system, when this ON action is commanded, in a THM sensor it stops flashing and in an ARC sensor it starts flashing. Since the sensors can be distributed close together, this also serves to differentiate THM and ARC sensors. When the OFF action is commanded, it returns to the normal state, flashing continuously or remaining on as explained above.

This command can be executed with the system operating normally.

Each sensor in the network has an address from 1 to 100 for THM and 1 to 100 for ARC as programmed at startup by a computer with the Zyggot management system installed (Free).

**ON:** Flash On button.

**OFF:** Flash Off button.

**GATEWAY:** Selects the Gateway to be triggered for flash in the Multi-Gateways version.

**SENSOR:** Button where you can enter the sensor number from 1 to 100. If 0 is entered, all sensors in the network will execute the Flash command (this is used to check if all sensors responded and recognized the command, and are therefore intact).

ON: Indicates that one or all sensors have the Flash command active.

OFF: Indicates that no sensor has the Flash command active.

The «ESC» button will not be visible if any sensor has the Flash command active to avoid forgetting to turn off the command before exiting the screen.

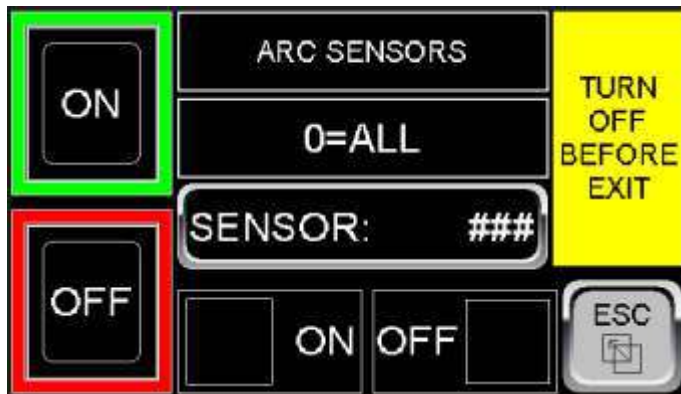
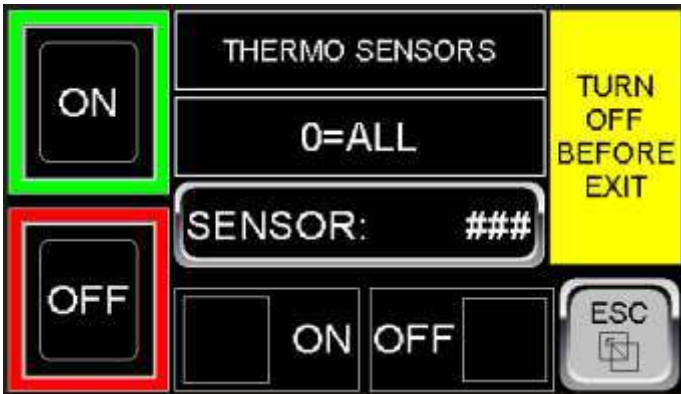

Tela <Arc Sensors> da versão Mono Gateway

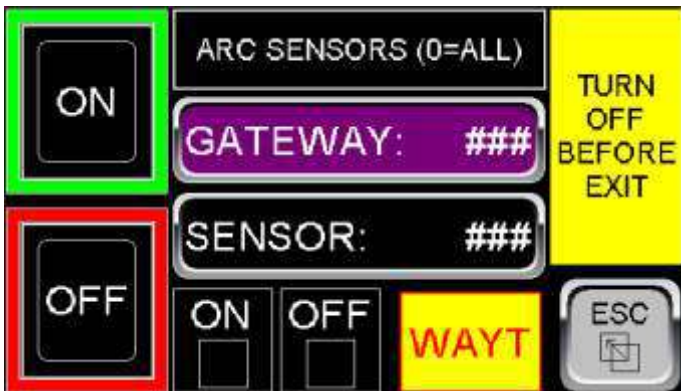

Tela <Arc Sensors> da versão Multi Gateway

# MAIN SCREENS FOR OPERATION

## 8-TARGET ALRM, 9- TARGET TRIP, 10- AIR ALARM, 11- AIR TRIP

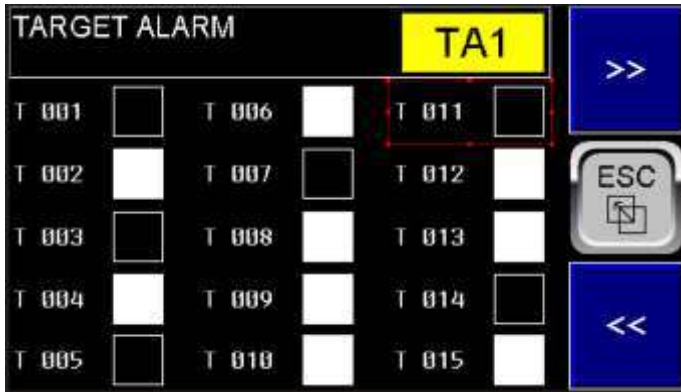

### TARGET ALARM TA1 to TA9:

There are 7 screens, scrolled by the >> and << keys.  
 Ta1 to TA7: Screen Index. Flashes if any of the Target values is above the programmed alarm value.  
 T001 to T100 (from screens TA1 to TA7): Indicates whether the temperature of each Target is above the programmed alarm value.



### TARGET TRIP TT1 to TT9:

There are 7 screens scrolled by the >> and << keys.  
 Tt1 to TT7: Screen Index. Flashes if any of the Target values is above the value programmed for Trip.  
 T001 to T100 (from screens TA1 to TA7): Indicates whether the temperature of each Target is above the value programmed for Trip.

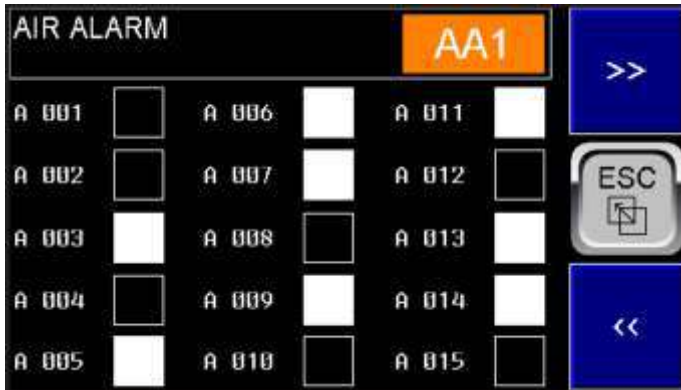

### AIR ALARM AA1 to AA9:

There are 7 screens scrolled by the >> and << keys.  
 Aa1 to AA7: Screen Index. Flashes if any of the Air (Body) values is above the value programmed for the alarm.  
 A001 to A100 (from screens AA1 to AA7): Indicates whether the temperature of each Air (Body) is above the value programmed for the alarm.

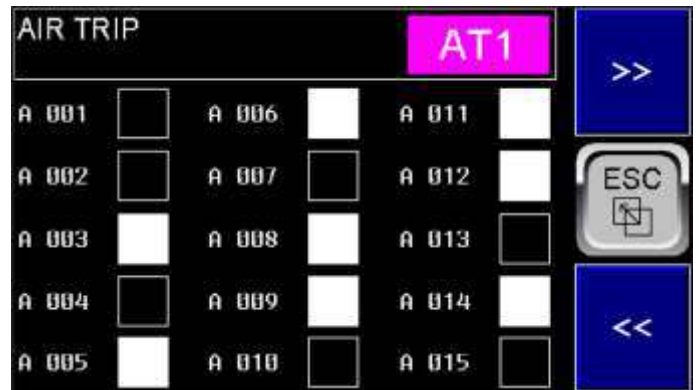

### AIR TRIP AT1 to AT7:

There are 7 screens scrolled by the >> and << keys.  
 AT1 to AT7: Screen Index. Flashes if any of the Air (Body) values is above the value programmed for Trip.  
 A001 to A100 (from screens AT1 to AT7): Indicates whether the temperature of each Air (Body) is above the value programmed for Trip.

# MAIN SCREENS FOR OPERATION

## 12- THM STATUS

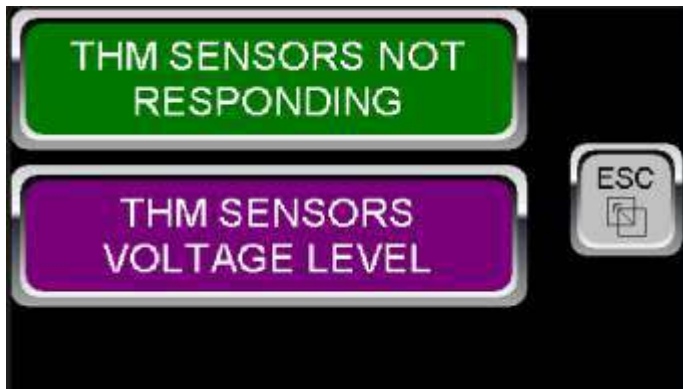

THM SENSOR VOLTAGE (V)			WAIT	TV01
GOOD	ACCEPTABLE	MARGINAL	NR	
V001: ##.##	V011: ##.##	V021: ##.##	>>	
V002: ##.##	V012: ##.##	V022: ##.##		
V003: ##.##	V013: ##.##	V023: ##.##		
V004: ##.##	V014: ##.##	V024: ##.##		
V005: ##.##	V015: ##.##	V025: ##.##		
V006: ##.##	V016: ##.##	V026: ##.##		
V007: ##.##	V017: ##.##	V027: ##.##		
V008: ##.##	V018: ##.##	V028: ##.##		
V009: ##.##	V019: ##.##	V029: ##.##		
V010: ##.##	V020: ##.##	V030: ##.##	<<	

THM SENSORS STATUS			WAIT	NRT1
RESPONDING	NOT RESPONDING			
S 001	S 006	S 011	>>	
S 002	S 007	S 012		
S 003	S 008	S 013		
S 004	S 009	S 014		
S 005	S 010	S 015		
			ESC	
				<<

### NOT RESPONDING NRT1 to NRT7:

There are 7 screens that are scrolled by the >> and << keys. S001 to S100 (from screens NR1 to Nr7): Indicates whether the respective THM sensor has stopped responding to the relay on the network. The indication only occurs after 2, 3 or 4 scans of all sensors, so that a reliable indication is obtained. Note that the correct indication may take some time depending on the number of sensors in the THM and ARC networks and the number of scans, which is why there is the "WAIT" indication, which informs that it must be waited for to turn off in order to obtain a correct indication. Sensors that are responding correctly are indicated in Green and if a sensor does not respond, its indication will be in red on the network. NOTE: Once the system is correctly configured and operating, the possibility of a sensor not responding is extremely remote. This is evidenced by thousands of systems operating worldwide with zero reported THM sensor failures.

### NOT RESPONDING TV01 to Tv04:

There are 4 screens that are scrolled by the >> and << keys. V001 to V100 (from screens TV01 to Tv04): Shows the power supply voltage reaching each THM sensor via the communication network with shielded sleeved cables and mini USB connectors. Note that there are 3 factory-set voltage levels, which are shown in 3 different colors: Green if it is within the optimal range (Nominal is 24 VDC, but much lower voltages are allowed), Yellow if it is within an acceptable range in which stable operation is safe or Red if the voltage is below a safe level for operation. Note that since the communication network can have different lengths, depending on the cabling used by each user, the sensors that are further away from the V5CON device (Interface) and therefore from the power supply may have a greater voltage drop in the wiring. In this case, the user simply needs to divide the network into more than one branch, since this is possible because the sensors are in parallel and as many branches as necessary can be used for better distribution in the cubicles of each MCC or Switchgear, using the accessory device code ZTA. It is also possible to supply power from both ends of the network. See wiring suggestions in the chapter "Typical Interconnections" earlier in this manual. In this way, by observing the voltage at each sensor, the user can be sure that the network is operating under safe conditions and it also serves to demonstrate that the sensor is communicating correctly, since it transmits voltages in the same way that it transmits temperature information (and arc-flash, depending on the type). A fourth color, Violet, shows that the sensor is not responding and the voltage indicated in the sensor voltage field will be 0.00.

# MAIN SCREENS FOR OPERATION

## 14- DIFFERENTIAL

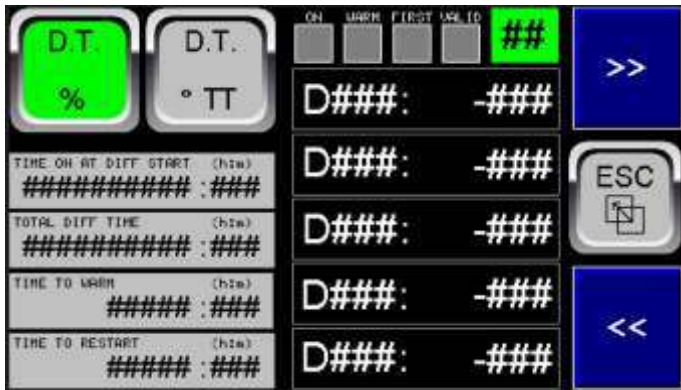

### DIFFERENTIAL 1 to 20:

There are 17 screens that are paged by the >> and << keys.

When activated, the sensor indexes are paged 5 by 5 from D1 to D100 and the other fields remain on the screen.

## (1) to ## (7): Screen index.

**DT%**: Button that selects to show the values as a percentage of variation in the programmed time. When selected, it changes from gray to green.

**TEMP (°TT)**: Button that selects the option to show the values as a differential of temperature variation in the programmed time. When selected, it changes from gray to green. °TT shows whether it is in Celsius or Fahrenheit.

**ON**: Indicator that the system has started the differential function (if programmed for this in the programming menu).

**WARM**: Indicates that the programmed heating period has passed, during which the system ignores the readings for calculating the differential variation, waiting for the system to stabilize in a normal operating temperature condition.

**FIRST**: Indicates that the first reading was performed after the 'Warm' period, on which the differential variations will be calculated for each new reading.

**VALID**: Indicates that the new reading is valid for differential calculations.

**TIME ON AT DIFF. START**: Shows for information purposes the 'On' time in hours and minutes since the system was started, as per screen 2 of the information screens.

**TOTAL DIFF. TIME**: Shows the total time since the first valid reading was performed and on which the differential is calculated.

**TIME TO WARM**: Shows a retroactive counter to zero of the remaining time to complete the 'Warm' period as programmed.

**TIME TO RESTART**: (only appears if set to 'Valid') Shows a retroactive counter to zero of the remaining time in hours and minutes, for automatic restart of a new differential period, if programmed for this in the programming menu. If not programmed for automatic restart, the system remains indefinitely considering the first reading performed after Warm. If restarted, manually or automatically, and the system is already in stable condition (after Warm), no new Warm period is expected and a new initial reading is performed for future differential calculations. Until the differential calculation begins, after Warm, this field is displayed as 0:0

**D### to D###**: Sensor indexes from 1 to 100 if the system is operating with an active and valid differential; otherwise, D0 is displayed in all 5 fields.

**###**: Differential value in % or temperature (°C or °F) for each index from D1 to D100, according to the selection in the % or Temp. selection buttons described above. This value is white if it is below the differential value programmed for alarm, yellow if it is above the differential level programmed for alarm, or red if it is above the differential level programmed for Trip. In both cases, it also flashes and changes color.

# MAIN SCREENS FOR OPERATION

## 15a- PROGRAMM REPORT.

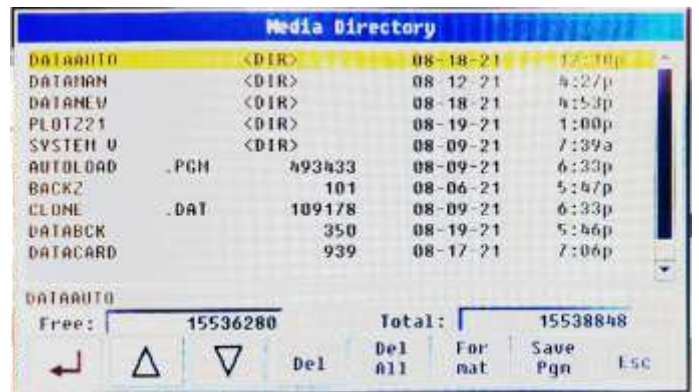
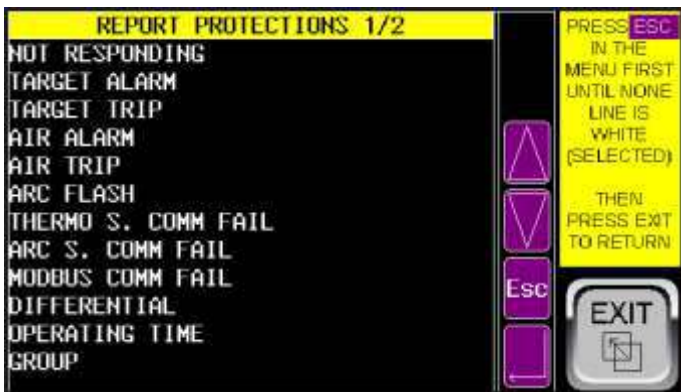
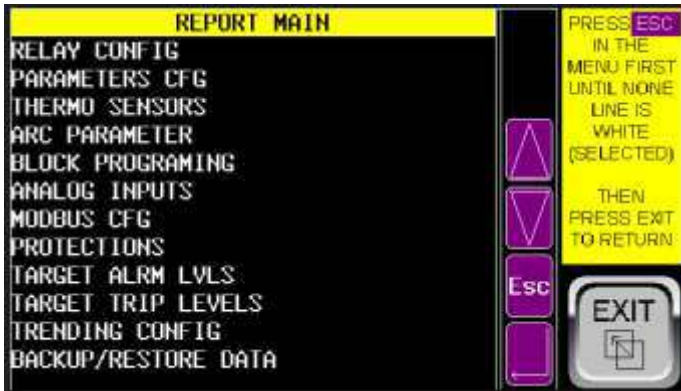

### REPORT SCREEN 1 to 5:

There are 5 screens that reproduce the Programming Menu and two more screens with system information, where you can check the various programming conditions without accidentally changing the programming. Note that the two system screens do not allow any data changes since they are only for viewing existing files and not for programming. The screen that shows the directories, although it presents change commands, will not work for security reasons. The user can, however, open the files on the computer and read and change them, but should refrain from changing the files in the root as this may compromise the operation. The files within the directories can be freely changed or deleted without risk. See details of the following parameters in the Programming Menu screens.

# MAIN SCREENS FOR OPERATION

## 15b- ETHERNET REPORT

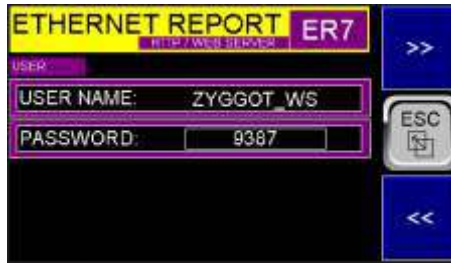
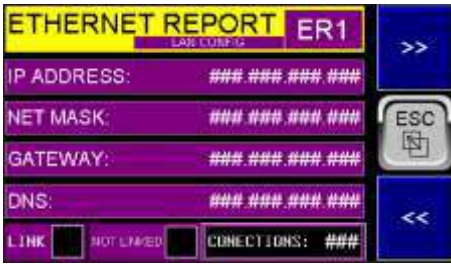

**ETHERNET REPORT SCREEN 1 to 9:**

There are 9 screens that reproduce the Ethernet Programming Menu, where you can check the various programming conditions without being able to change the programming inadvertently. None of the screens allows commands or changes, with the exception of screen ER3, where you can choose an address and command a PING action to check if a certain device on the network is responding.

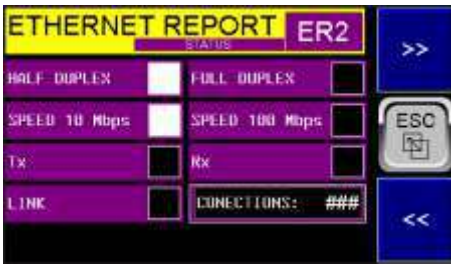

The fields on all these screens will be detailed later. Here we will only comment on the function of each one.

Screens ER1 and ER2 refer to the main Ethernet configuration parameters. Screen ER1 shows the parameters and screen ER2 shows the connection status.



Screen ER3 refers to the **ICMP - Internet Control Message Protocol** protocol and it is possible to PING the address of a certain device.

Screen ER4 refers to the **TCP/IP - Transmission Control Protocol (Modbus TCP Server or Modbus Slave)**. Through this protocol, Modbus Over Ethernet communication can be performed, using all the parameters and addresses described in the Modbus Map at the end of this manual.



Screen ER4 refers to the **TCP/IP - Transmission Control Protocol (Modbus TCP Server or Modbus Slave)**. This protocol allows Modbus Over Ethernet communication, using all the parameters and addresses described in the Modbus Map at the end of this manual.



Screen ER4 refers to the **TCP/IP - Transmission Control Protocol (Modbus TCP Server or Modbus Slave)**. The ER5 screen refers to the **IP protocol - Internet Protocol (Ethernet IP Server)**.

The ER6 screen refers to the **FTP protocol - File Transfer Protocol**. Through which you can read and access the files on the memory card inserted in the respective slot of the relay and where the temperature readings etc. are recorded using a browser.

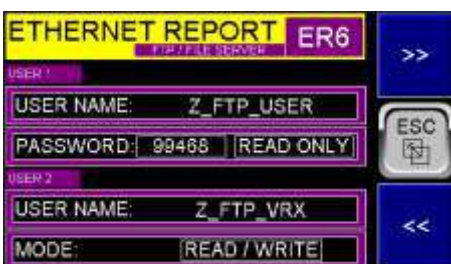

The ER7 screen refers to the **HTTP protocol - Hypertext Transfer Protocol**.

The ER8 screen refers to the **ASCII Over TCP/IP protocol - ASCII Transmission Control Protocol**.

The ER9 screen refers to the **NTP protocol - Network Time Protocol** through which you can obtain precise times from predefined NTP servers.

# MAIN SCREENS FOR OPERATION

## 16- ARC FLASH, 17- ARC SEQUENCE



Tela <Arc Flash> da versão Mono Gateway



Telas A e B <Arc Flash> da versão Multi Gateway

### ARC FLASH - OCCURRENCE INDICATION AF1 to Af7:

There are 7 screens that indicate whether an ARC FLASH has occurred. The indication is by color and the indicated color will be white if an ARC FLASH has occurred and will remain in this condition until it is reset by the relay reset keys, or by the Gateway reset input or by Modbus communication. Note that if a Flash has occurred, the circuit breaker connected to the Gateway/Trigger will have already tripped instantly and on the Menu screen (Main) the «ARC FLASH» key and also the «ALARM» key will be flashing to draw the operator's attention. If programmed in the corresponding protection menus and an alarm output connected to a buzzer is used, the buzzer will be active and the sound can be silenced by the «MUTE» key present on several relay screens, before a possible «RESET» command. If a «RESET» is commanded before checking for the occurrence of ARC FLASH on the screens above or the sequence of arc occurrences on the screens further ahead, the indication of which sensor was activated will be lost, leaving only that there was an activation in the History, therefore, care must be taken when checking for a possible occurrence.

The screens also indicate the Gateway currently being scanned, updating the fault indications for each of them with each complete scan in the case of the multi-gateway version and if the scanning mode is in «Automatic», in

which case a message will be displayed warning that if you want to observe one gateway at a time, you must change to manual scanning mode.

Once changed to manual scanning mode, the screen will show two buttons to increase «Up» or decrease «Down» the number of the gateway being displayed. This allows for easier observation of the sensors with fault detection.



### ARC FLASH SEQUENCE - (ORDER OF OCCURRENCE) - AFS1 to AFS3

There are 3 screens that indicate the sequence of occurrence in case of an ARC FLASH occurrence. The first sensor to detect the arc will be marked with the indication "1", the second, if any, will be marked with the indication "2" and so on, so it is necessary to page through the 4 screens to check the indexes of all the sensors, to be sure of the order of occurrence. As explained in the previous item, these indications remain until they are reset by the relay's RESET keys or by the Gateway's Reset input or by a command via Modbus.

The same explanations given in the Arc Flash screens apply on this page regarding the scanning mode, phrase to change the mode, etc.

The buttons that appear in the manual scanning mode allow checking the Arc Flash sequence in a stable way since there is no update of the sequences for each gateway in the system. The «Up» and «Down» keys allow you to select the gateway to be checked easily.

# MAIN SCREENS FOR OPERATION

## 18- ARC STATUS / TIMESTAMP

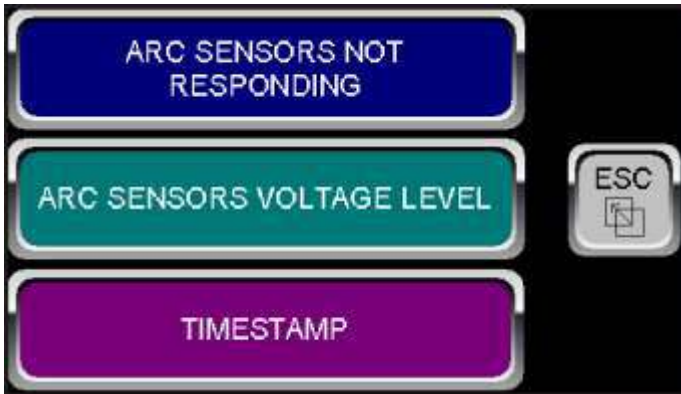

Mono Gateway Version «Arc Status» Screen



Multi Gateway Version «Arc Status» Screen



### NOT RESPONDING NRA1 to NRA7: Accessed by pressing <ARC SENSOR NOT RESPONDING>

There are 7 screens, scrolled by the >> and << keys. S001 to S100 (screens NRA1 to NRA7): Indicates whether the respective arc sensor has stopped responding to the gateway in the network. Note that the valid indication for each gateway is indicated by the change of the word «WAIT» to «VALID» depending on the number of sensors in the THM and ARC networks. The same observations as above apply to the «Up» and «Down» keys to select the gateway in manual scanning mode. Sensors that are responding correctly are indicated in Green and if a sensor does not respond, its indication will be in Red on the network. The «Gateway» field indicates the Gateway currently being scanned, in the Multi Gateway version. With each Scan, the screen will be refreshed with the current conditions of each Gateway if the scanning mode is in «AUTO» or will remain static on the Gateway selected on the screen if it is in «MANUAL» mode.



### ARC SENSORS VOLTAGE LEVEL AV01 to Av04:

There are 4 screens that are scrolled by the >> and << keys. V001 to V100 (screens TV01 to Tv04): Shows the supply voltage reaching each ARC sensor via the communication network. Note that there are 3 factory-set voltage levels, which are shown in 3 different colors: Green if it is within the optimal range (Nominal is 24 VDC, but much lower voltages are allowed), Yellow if it is within an acceptable range in which stable operation is safe, or Red if the voltage is below a safe level for operation but still operating, otherwise the sensor would be in the "Not responding" condition. Note that since the communication network can have different lengths, depending on the cabling used by each user, the sensors that are further away from the V5CON device (Interface) and therefore from the power supply may have a greater voltage drop in the wiring. In this case, the user simply needs to divide the network into more than one branch, since this is possible because the sensors are in parallel and as many branches as necessary can be used for better distribution in the cubicles of each MCC or Switchgear, using the accessory device code ZTA. It is also possible to supply power from both ends of the network. See wiring suggestions in the chapter "Typical Interconnections" earlier in this manual.

This way, the user can be sure that the network is operating under safe conditions.

A fourth color, Violet, shows that the sensor is not responding and the voltage indicated in the sensor voltage field will be 0.00.

The same previous observations apply regarding the scanning mode and the "Up" and "Down" keys.



### GATEWAY STATUS GF1 to GF7:

Accessed by pressing <MULTI GATEWAY STATUS>

There are 7 screens, scrolled by the >> and << keys. G1 to G100: Indicates whether the respective gateway has detected any fault. Note that regardless of the indication on this screen, the Gateway has already activated the corresponding alarm or trip output, according to its programming. In the case of arc tripping, the trip output is activated in less than 300 µs. If the "Scan Mode" parameter has been selected as "On Fail Do Scan", then the scanning of the gateways continues even if a fault has been detected by one of them. In this case, the operator must check on the screens above which gateways are in a fault detected condition and manually select the Gateway to be scanned again and check the faults detected, before activating the Reset and erasing the faults stored by the gateway and relay.

# MAIN SCREENS FOR OPERATION

## 18- ARC STATUS / TIMESTAMP



Mono Gateway Version <Timestamp> Screen



Multi Gateway version <Timestamp> screen

### TIMESTAMP TS1:

Accessed by pressing <TIMESTAMP>

The last 50 ARC FLASH or CHAIN events are memorized by each Gateway in the system and can be scrolled through using the UP or DOWN keys or selected directly by their index entered in the EVENT key. Event number 1 is the last one that occurred and is marked as <Last Event> and event 50 is the oldest and will be marked as <Older Event>.

The events can be deleted in the menu (Screen below). As long as they are not deleted, they will be memorized in the Gateway even if the power is turned off. If more than 50 events occur, the newest events are added and the oldest ones are removed from the event queue.

In the case of the Multi Gateway version, you must first select the <Manual> mode and then select the Gateway to be read.

As a result, the occurrence field will indicate one of two possibilities:

A) ARC FLASH > SENSOR NUMBER: ###

B) CHAIN INPUT

and the date and time each event occurred.

In case of empty event memory, the dates and times will be zero and the cause field will have no indication whatsoever.



### SCAN GS1:

Accessed by pressing <SCAN> (Multi Gateway version only)

On this screen, the operator can select the Scan Mode between «AUTO» and «MANUAL». The system will always be in <AUTO> mode unless the operator selects «MANUAL» on this screen.

The mode will return to «AUTO» if the elapsed time indicated in «Time to Return to Auto» reaches zero. This time starts at 600 seconds.

The «Manual» mode is basically used so that the operator can observe the status of «Not Responding», «Voltage Levels», etc. in more detail, without the indication page being renewed with each scan.

**IMPORTANT NOTE:** Even if the mode is in "Manual" and the scan is stopped on a single Gateway, the Arc Flash, Chain protection, etc., is not disabled on any gateway in the system, since they operate independently of the relay. The relay only shows, non-synchronously, the events and indications stored or current on each gateway. The activation of faults and alarms originated on the relay by reading the conditions and status of the gateways, these may stop acting while the system is scanning a given gateway and an alarm or trip condition programmed on the relay occurs on another gateway. Note that these possible faults, programmed on the relay, are not critical to safety, such as sensors "not responding", or "voltage levels" outside the ideal condition, etc., which can be detected in a complete scan of the system and generate an "Alarm" or "Trip" independent of the "Trip" and "Output 1 or 2" outputs of the Gateways. In this case, it is always preferable to program the faults detected by the relay in "Alarm" and not "Trip" to avoid unnecessary system shutdowns, as these are only predictive conditions and can be managed during the system's normal shutdown time.

# MAIN SCREENS FOR OPERATION

## 19- ALARM, 20- HISTORY

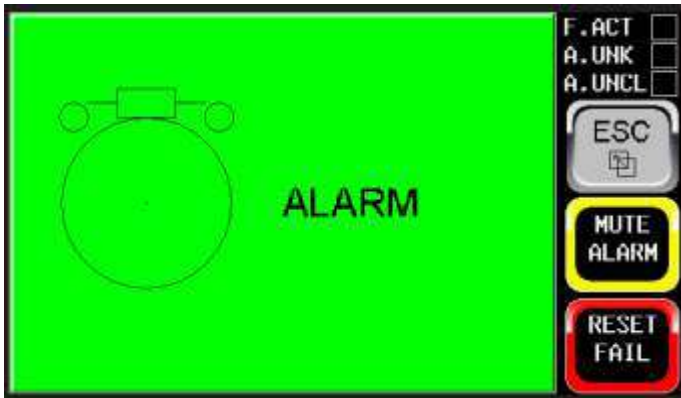

### ALARM SCREEN:

**ALARM:** This is a screen where you can check all Alarms, Faults and events that have occurred, with date and time (Time Stamp), in addition to being able to acknowledge them (Acknowledge) or (ACK) or clear them (Clear). To do this, touch any point on the Alarm screen that is green in the normal condition or red in the condition of activated and unacknowledged (ACK) or cleared (CLR) faults or yellow if there are faults with ACK but not Clear.

**F.ACT:** Indicates that there is an active fault that has not been reset.

**A.UNK:** Indicates that there is an unrecognized fault (Unacknowledge).

**A.UNCL:** Indicates that there is a fault that has not been returned or cleared (Uncleared).

**MUTE:** Alarm mute button. Turns off the alarm output.

**RESET:** Fault reset and tripping shutdown button. Only works after Mute.



### HISTORY SCREEN:

**HISTORY:** This is a screen where you can check all the events that have occurred, with date and time (Time Stamp), but you cannot acknowledge or clear them. For this, there is another screen, accessed from within the programming menu. Tap anywhere on the History screen.

The events stored include the Ack and Clear actions performed on the Alarm Screen above, as well as the deactivation of the fault that occurred (Return).

The other fields are the same as those on the Alarm screen above.

# PROGRAMING

## 21- MENU

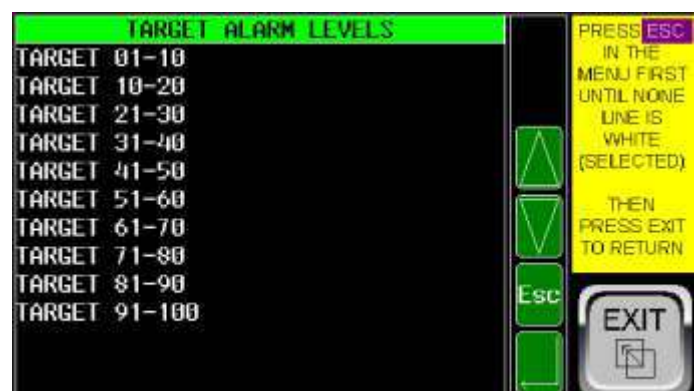

In the MAIN "Programming Menu" there are 13 Sub-items or Submenus available, namely:

- M01: Relay Config.
- M02: Parameters Cfg.
- M03: Thermo Sensors.
- M04: Arc Parameters.
- M05: Block Programming.
- M06: Analog Inputs.
- M07: Modbus Cfg.
- M08: Protections.
- M09: Target Alarm Levels.
- M10: Target Trip Levels.
- M11: Trending Config.
- M12: Clear Data
- M13: Backup/Restore Data
- M14: Ethernet

Sub-item 4 is subdivided as follows:

- M05: Block 1
- M05: Block 2
- M05: Block 1
- M05: Block 2
- M05: Do Block Programm

And sub-item 7 is subdivided into two others, namely:

- M08: Protections 1/2
- M08: Protections 2/2

And sub-item 9 is subdivided into 10

- M9: Target 01-10 to M9: Target 11-120

And sub-item 10 is subdivided into 10

- M10: Target 01-10 to M10: Target 11-120

# PROGRAMING

## 21- MENU

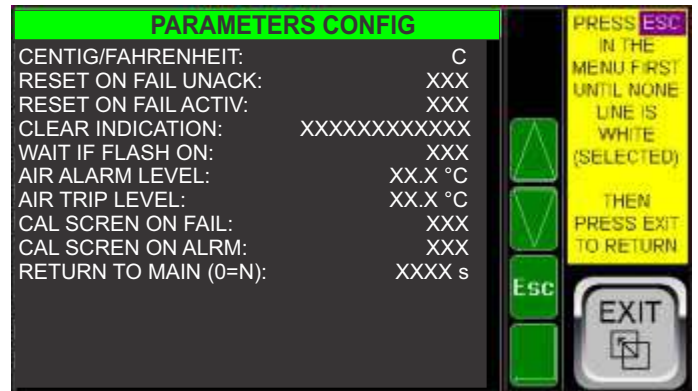

### M01-RELAY CONFIG

- 01.1- Language:** (English, Portuguese, Spanish).
- 01.2- System Type:** (Thermo Only, Arc Flash Only, Thermo + Arc Flash). Select one of the operating modes.
- 01.3- Set Real Time Clock:** Enter the correct date and time, if necessary.
- 01.4- Screen Brightness:** Adjust the screen brightness between 50 and 100% for normal operating conditions.
- 01.5- Save Screen (N. Fail):** Select Yes to start reducing the screen brightness after the time programmed below. No to not perform this action. This action will not be performed if it is in failure. (N. Fail) and if it is in screen saving mode and a failure occurs, the screen will return to its normal brightness until the failures are reset.
- 01.6- Save Screen Time:** Adjust the screen inactivity time so that it has reduced brightness. When the screen is touched, the brightness returns to normal and this time starts counting again.
- 01.7- Saving Brightness:** Adjust the screen brightness between 0 and 50% for the screen saving condition.
- 01.8- Plant:** Enter the description of the Plant with a maximum of 10 letters.
- 01.9- Location:** Enter the description of the installation location with a maximum of 10 letters.
- 01.10- Panel:** Enter the description of the panel with a maximum of 10 letters.
- 01.11- Mem Card Error Act:** (None, Log). Select the options None if you do not want the card error alarm to occur or Log if you want the failure to occur.
- 01.12- Menu Pass:** Enter the new Password if necessary, with a maximum of 5 numbers. If set to zero, the programming menu can be accessed by the operator without a password, which entails a risk and is not advisable.
- 01.13- Clone Pass:** Enter the new Password if necessary, with a maximum of 5 numbers to access the Relay Clone menu.
- 01.14- RST Differ. Pass:** Enter the new Password if necessary, with a maximum of 5 numbers to access the Restart Differential Data menu. This request is made to the operator each time the relay is turned on again with active differential data. A new differential cycle can be started from this moment or the initial readings of the differential system valid at the time can be maintained.

### M02-PARAMETERS CFG

- 02.1- Centigrade/Fahrenheit:** (C or F). Choose the Temperature unit.
- 02.2- Reset On Fail Unacknowledged:** (Yes, No). Choose Yes to allow Reset with an unacknowledged failure (Ack). The failure is acknowledged on the Alarm screen. It flashes if there is a non-Ack alarm.
- 02.3- Reset On Fail Uncleared:** (Yes, No). Choose Yes to allow Reset with an unacknowledged failure cleared or reset (Clr). The failure is reset on the Alarm screen. It flashes if there is a non-Clr alarm.
- 02.4- Clear Indication:** (Auto, After Reset). If «Auto» is chosen, the yellow and red indications on the main temperature screens return to white if the temperature returns to a value below the alarm or trip point, but the squares indicating Alarm or Trip remain on until the «Reset» key is pressed. If «After Reset» is selected, the yellow and red colors continue to indicate an alarm or trip that occurred even if the temperatures have returned to normal, and the indicator squares remain active. The colors and fault indicators only return to normal after «Reset» is activated. This is the factory condition and the safest, to indicate faults that have already returned to normal conditions.
- 02.5- Wait if Flash On:** (Yes, No). Condition to return to the main screen automatically, as explained in the «Return to Main» parameter below. If «Yes» is selected, it does not automatically return to the main screen if Flash is On.
- 02.6- Air Alarm Level:** Alarm level for air or sensor body. Valid for all sensors.
- 02.7- Air Trip Level:** Trip level for air or sensor body. Valid for all sensors.
- 02.8- Cal Screen On Fail:** (Yes, No). If set to «Yes», in the event of a fault with Trip, the alarm screen will be automatically displayed.
- 02.9- Cal Screen On Alarm:** (Yes, No). If set to «Yes», the alarm screen will be automatically displayed in the event of an Alarm.
- 02.10- Return to Main:** Time in seconds after which the relay will automatically display the main screen 1. If set to zero, there will be no automatic return. There will also be no automatic return if the screen is in the programming menu or with Flash activated as per parameter 02.4 above.





# PROGRAMING

## 21- MENU



«Arc Parameters» screen Mono Gateway version

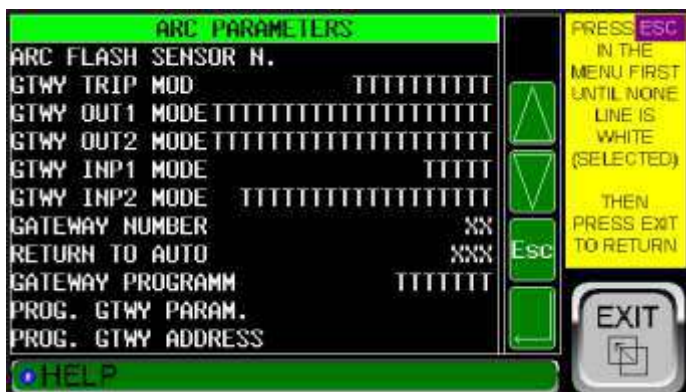

«Arc Parameters» screen Multi Gateway version



### M04-ARC PARAMETERS

**04.1- Arc Flash Sens.N°.**: Enter the number of arc flash sensors in the network between 1 and 100 for each of the up to 40 possible gateways.

**04.2- Gateway Trip Mode:** (Retentive, Pulse 3s). Choose the desired option.

**04.3- Gateway Output 1 Mode:** (Trip, Armed, Alarm, Remote1). The Gateway already has a «Trip» output with static and mechanical contact, but if you want to replicate the Trip output with another mechanical N.O. contact, choose the «Trip» option (Note: this contact is not fast, like the dedicated one that operates at 250 uS). If «Armed» is selected, this output will be active (closed) if the relay is correctly programmed and without a trip that has not been reset. If «Alarm» is selected, this output will be activated in the event of a fault programmed for alarm or trip. If «Remote 1» is selected, this output will be activated, depending on the Zyggot relay programming, also replicating any fault detected by the Zyggot relay.

**04.4- Gateway Output 2 Mode:** (Trip, Armed, Alarm, Remote2): Same details as described above in 05.3.

**04.5- Gateway Input 1 Mode:** (None, Reset). If «Reset» is selected, an

active input (24 VDC) will clear the Gateway's active faults, reverting any normal or programmed output to the normal state, without fault. If «None» is selected, this input will be unused.

**04.6- Gateway Input 2 Mode:** (None, Reset, Inhibit - DSBL Trip, Chain). If «None» is selected, this input will be deactivated. If «Reset» is selected, this input will operate in the same way as described above for input 1. If «Inhibits - Disable Trip» is selected, an active signal will be activated. (24VDC) on this input will inhibit the activation of the Trip due to Arc or any other fault.

**ATTENTION:** Use with extreme caution and only for commissioning tests, normally with temporary wiring or by means of a Yale type switch, since if left closed, it will leave the system without protection. If «Chain» is selected, an active input (24 VDC) will cause the TRIP output to be activated, if the Gateway is programmed for Chain active. It can be used to trip an upstream circuit breaker, for example, in the event of an Arc Flash in another relay downstream.

**04.7- Gateway Number: (1 to 100).** Enter the number of gateways connected to the relay, from 1 to 100. In the case of a single gateway, it is necessary to enter the number 1 in this parameter.

**04.8- Return to Auto (0=No):** (20 to 600 s (up to version V05.70) or (0 to 600 s (version V05.71 onwards): Time that starts when scanning changes to "Manual" and, upon completion, commands the change of scanning to "Automatic" mode. From version V5.71 onwards, there is the option to select (0). In this case, after a command on the screen or via Modbus (%M1301) to change the Scan mode from "Auto" to "Manual", the return to Auto will no longer occur unless there is a command on the display or via Modbus from "Manual" to "Auto" (%M1302). Caution: This use requires care because, in manual mode, the relay only monitors the selected Gateway and no longer sees the others, although the alarms and trips generated in the Gateways themselves remain active and operational, not compromising the system's security. Only the monitoring and alarms and trips generated by Relays related to Gateways not currently being monitored may be inactive. This option to always keep in Manual Scan mode can facilitate monitoring by the DCS without having to periodically command manual mode. Simply select the Gateway and read the values related to it. In Automatic Scan mode, from version V05.71 onwards, it is also possible to read the Arc flags of all gateways and sensors (from 1 to 96 of each Gateway) from Flag %M2001 onwards, up to %M5840 and the trip flag of each Gateway from Flag %M1601 to %M1640.

**04.9- Gateway Programm:** (Disable, Enable): You must select «Enable» so that parameter programming can be performed on the system gateways.

**04.10- GTWY PARAM.:** (Somente na versão Multi Gateways) Este recurso deverá ser acionado após a primeira programação de dados e toda vez que se alterar parâmetros referentes aos gateways de arco. Para efetuar a programação, se deverá selecionar o **Gateway** a ser programado (**0 para programar todos com os mesmos parâmetros**) e teclar «Proceed». **ATENÇÃO:** Em caso de se selecionar «0» todos os gateways selecionados serão programados com os mesmos parâmetros. Caso se deseje usar parâmetros diferentes se deverá alterar os mesmos no menu principal antes de cada grupo de Gateways serem programados com tais parâmetros ou então usar o software Superger para programar previamente cada gateway e não utilizar este recurso no relé.

**04.9- Gateway Programm:** (Disable, Enable): «Enable» must be selected so that parameter programming can be performed on the system gateways.

**04.10- GTWY PARAM.:** (Only in the Multi Gateways version) This feature must be activated after the first data programming and every time parameters related to the arc gateways are changed. To perform programming, select the Gateway to be programmed (0 to program all with the same parameters) and press «Proceed». **ATTENTION:** If «0» is selected, all selected gateways will be programmed with the same parameters. If you wish to use different parameters, you must change them in the main menu before each group of Gateways is programmed with such parameters or use the Superger software to previously program each gateway and not use this feature on the relay.

**04.11- PROG. GTWY ADDRESS:** (Only in the Multi Gateways version). This feature should only be used to change the Modbus address of each gateway, in the case of systems with multiple gateways. In the case of a single Gateway system, it should be at address 200 and in the case of Multiple Gateways, the addresses should be 200, 201, 202, etc. up to a maximum of 239. The gateways are shipped from the factory with the default address 200. Therefore, in the case of more than one gateway on the same relay, their addresses should be changed as described in the relay's «Help» screens. Optionally, you can use the Superger software to previously program each gateway with the correct addresses.

# PROGRAMAÇÃO

## 21- MENU

### IMPORTANT NOTES:

1- Although this feature is present here for convenience when modifying a specific gateway, it is always preferable to leave the programming parameter in "Disable" and use the "Superger" software to program each gateway only once during Startup.

2- In the Mono gateway version, the parameters are automatically sent to the only gateway in the system when the system starts or when exiting the programming menu. In this version, the gateway must be previously configured for Modbus address 200.

3- If you do not know which address a specific gateway is configured for, simply press the "Reset" key on the gateway through the front hole using a paper clip. When this key is pressed, the front LED changes color for one second and the address returns to 200. The other parameters are not changed.

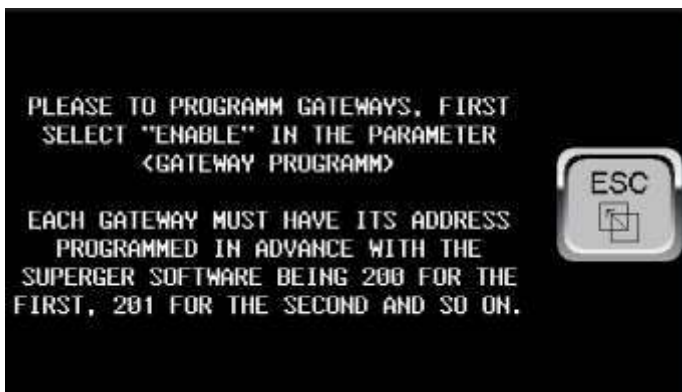
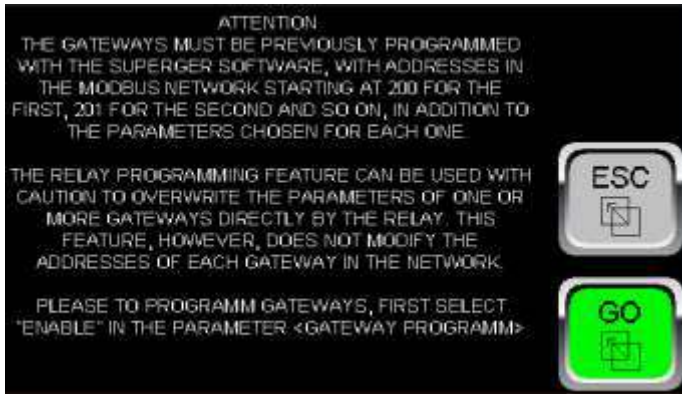

### M04- ARC PARAMETERS (details of item 4.11) (Only Multi Gateway Version - See note 2 below)

**04.11- Do Programm Gateway:** When selecting this option, the screen above will appear with safety warnings and instructions to first select «Enable» in the «Gateway Programm» parameter.

When pressing «GO», one of the following two screens will be displayed. If the programming parameter is set to «Disable», the second screen will be displayed. If it is set to «Enable» and there is more than one gateway in the system, the third screen will be displayed, indicating the actual programming. However, if there is only one Gateway in the system, the fourth screen will be displayed, warning that programming in this case will be carried out automatically each time the menu is exited or the relay is initialized.

On the actual programming screen (third screen on the side), it will be necessary to initially select «MANUAL», then enter the number of the gateway to be programmed (0 for all at the same time) and select the «Proceed» key, entering «YES» and «ENTER». Programming will then begin and the «Programming GTWY» field will show which gateway is currently being programmed. Once the «YES» indication on the «Proceed» key is finished, it will return to «NO».

You will not be able to exit this screen until all gateways have finished programming.

#### Note:

1- The saved parameters are only inserted in the "ARC PARAMETER" menu. The gateway network or the factory parameters of the Modbus communication of the gateway will not be altered in this procedure.

2- In the Mono Gateway Version, just set the parameter «Prog. GTWY PARAM.» If "Enable" is selected so that the new parameters that may be changed in the arc menu are recorded in the system's only gateway.

# PROGRAMING

## 21- MENU

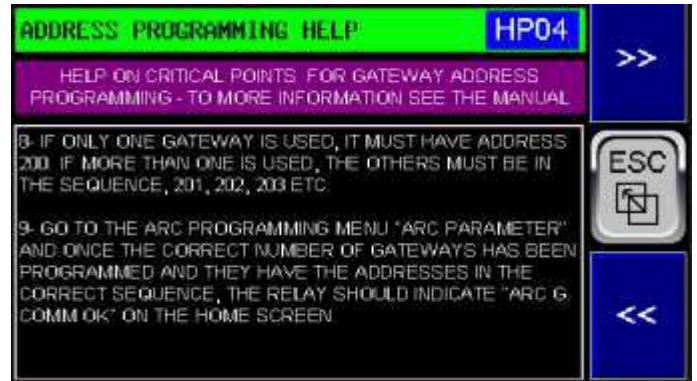
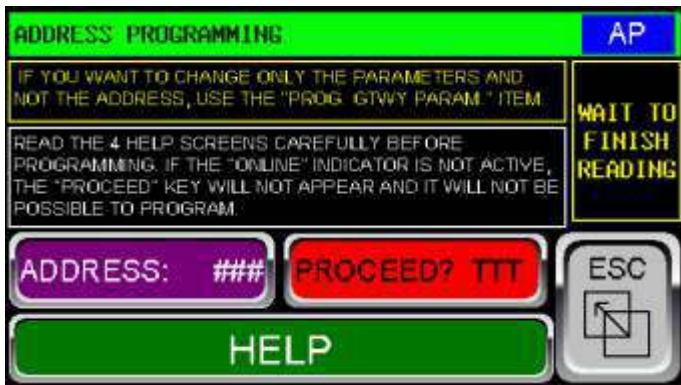

**M04- ARC PARAMETERS > PROG ADDRESS (Only in the Multi Gateways version - See note below). (details of item 4.12).**

**04.12- PROP. GTWY ADDRESS.:** When selecting this option, the **AP** screen above will appear and when pressing **«HELP»**, 4 screens can be accessed with instructions regarding this action.

Once you have read and understood the instructions, select the new address of the Gateway to be programmed, always starting from the gateway already configured and communicating, which should have address **200**. Then, using this Address key, you can select from 201 to 239. If address 200 is selected, it will not be changed on the gateway but will be used to test the action.

Note that the **«Proceed»** key only appears if the gateway to be programmed is **«Online»** (with address 200, therefore).

Once you have selected the new address and the **«Proceed»** key is displayed, simply select **«Yes»** on it and the gateway will be programmed with the new address. Note that this action does not change the parameter data previously programmed on the gateway in question.

Programming will start after this and as soon as it finishes, the **«YES»** indication on the **«Proceed»** key will return to **«NO»**.

The remaining instructions are on screens **HP01** to **HP04** above.

**Note:** In the mono gateway version there is no option to record the Modbus address on it, as it will always be **200**. If it is different, simply perform the **«Reset»** operation using a clip in the small hole at the top. When the reset switch is pressed, the top LED changes color momentarily and the address will be changed to **200**, making it ready for use. The other parameters are automatically recorded when the gateway is connected to the relay and eventually rewritten if they are changed in the programming menu.

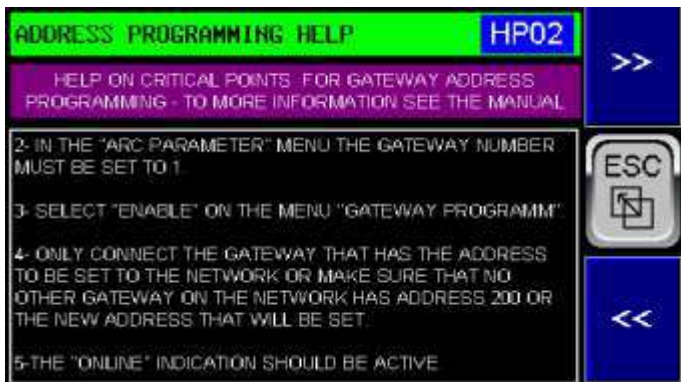



# PROGRAMING

## 21- MENU

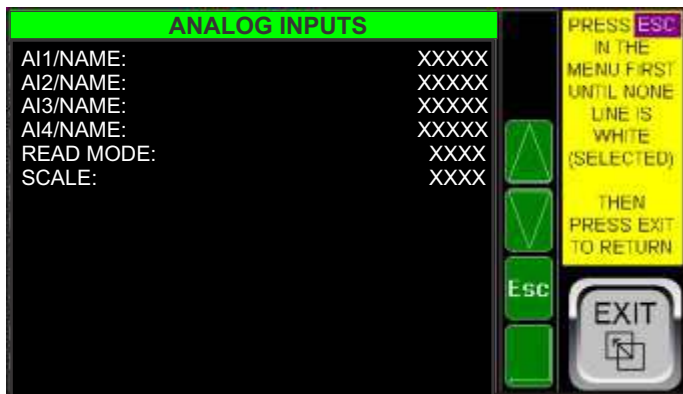

### M06-ANALOG INPUTS

- 06.1- AI1/NAME:** Enter the name of the analog input, with up to 5 characters, to facilitate its identification.
- 06.2-AI2/NAME:** Same.
- 06.3-AI3/NAME:** Same.
- 06.4-AI4/NAME:** Same.
- 06.5-Read Mode:** (% , Temp). Reading mode and display on screens, as a percentage in relation to the full scale (5V) or Temperature. The next parameter defines the full scale for the temperature.
- 06.6- Scale:** xxxx. Enter the temperature that is equivalent to the full scale (5V) of the analog inputs.

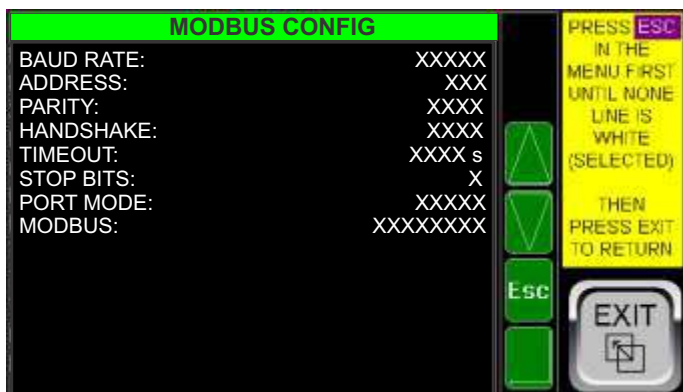

### M08- MODBUS CONFIG

This menu is related to the Modbus communication port for the user to optionally connect to the DCS system. (It is not related to the communication port with the sensors)

- 07.1- Baud Rate:** (9600, 19200, 38400) Enter the required Baud Rate.
- 07.2- Address:** (1 to 247): Enter the network node address for this relay.
- 07.3- Parity:** (None, Odd, Even). Choose the required parity.
- 08.4- Handshake:** (None, XON/XOFF, CTS/RTS, MD/HALF), Choose the required Handshake.
- 07.5- Timeout:** (0 to 1023 s). Enter the required Timeout.
- 07.6- Stop Bits:** (1 or 2). Choose the required value).
- 07.7- Port Mode:** (Rs232, Rs485). Select the mode used.
- 07.8- Modbus:** (Active, Inactive). To turn Modbus on or off. If not used, leave it in «Inactive».

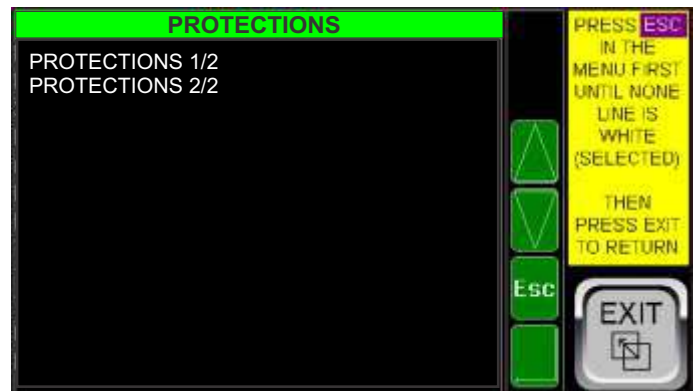

### M08- PROTECTIONS

This menu is divided into three (1/2, 2/2 and 1/3) the first two referring to the THM system and the third to the ARC-Flash system and will be detailed later.



### M08- PROTECTIONS 1/2

In this menu, the parameters relating to the protections shown above will be programmed.

# PROGRAMING

## 21- MENU

**ACTION:** The selection possibilities for the Action parameter of each of the faults may include one or more options as follows and informed in the parenthetical part of each fault described below and will not be further detailed: (**None, Log, Alarm, Trip**). In «None» this fault will not be considered. In «Log», it will be logged on the Alarm screen but the Alarm condition will not be triggered. In «Alarm» the fault will be logged and the Alarm condition will be triggered. In **Trip**, the fault will be logged, the Alarm condition will be triggered and the Trip condition will be triggered.

**AUX OUTPUT:** The options for all faults are «None», «D.O.3», «D.O.4», «EB1:Aux1», «EB2:Aux2», «EB3:Aux3», «EB4:Aux4»..... «EB8:Aux8». This will not be detailed in each fault description below, as what is described here applies to all of them. Note that the outputs «D.O.1» and «D.O.2» are dedicated to «Alarm» and «Trip» and the outputs D.O.3 and «D.O.4» are programmable and are located on the relay, while the others, also programmable, are located on the EBLOCK 88x expansion block.

**Note:** More than one fault can be assigned to the same output and it will switch if any of the faults assigned to it occurs.



### M09.2- TARGET ALARM

This fault will occur if one or more sensors reach the alarm temperature level for the target, programmed for each of them in the corresponding menu.

**08.2.1- Action:** (None, Log, Alarm). Select the option. Note that there is no «Trip» option.

**08.2.2- D. Output:** (None, D.O.3, D.O.4, EB1: Aux1 to EB8: Aux8). Select the option.



### M08.1- THM S. NOT RESPONDING

This fault will occur if one or more sensors are not responding in the sensor network.

**08.1.1- Action:** (None, Log, Alarm). Choose the desired option.

**08.1.2- Aux Output:** (None, D.O.3, D.O.4, EB1: Aux1 to EB8: Aux8). Choose the desired option.

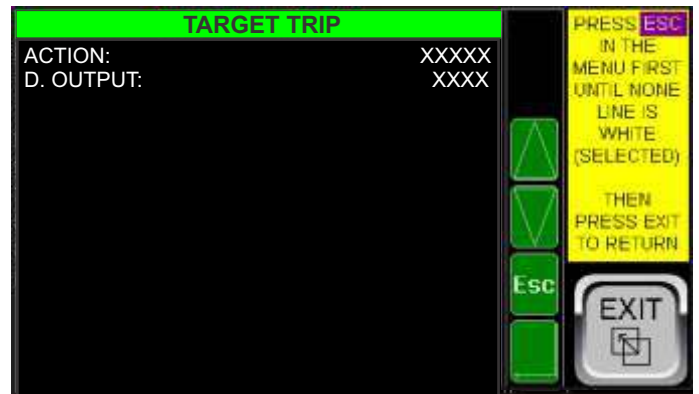

### M09.3- TARGET TRIP

This fault will occur if one or more sensors reach the Trip temperature level for the target, programmed for each of them in the corresponding menu.

**08.3.1- Action:** (None, Log, Trip). Choose the option. Note that there is no «Alarm» option which will also be triggered together with the Trip.

**08.3.2- Aux Output:** (None, D.O.3, D.O.4, EB1: Aux1 to EB8: Aux8). Choose the option.

# PROGRAMING

## 21- MENU



### M08.4-AIR ALARM

This fault will occur if one or more sensors reach the alarm temperature level for the air (sensor body), programmed for each of them in the corresponding menu.

**08.4.1- Action:** (None, Log, Alarm). Select the option. Note that there is no «Trip» option.

**08.4.2- Aux Output:** (None, D.O.3, D.O.4, EB1: Aux1 to EB8: Aux8). Select the option.



### M08.5-AIR TRIP

This fault will occur if one or more sensors reach the Trip temperature level for the air (sensor body), programmed for each of them in the corresponding menu.

**08.5.1- Action:** (None, Log, Trip). Choose the option. Note that there is no «Alarm» option which will also be triggered together with the Trip.

**08.5.2- Aux Output:** (None, D.O.3, D.O.4, EB1: Aux1 to EB8: Aux8). Choose the option.

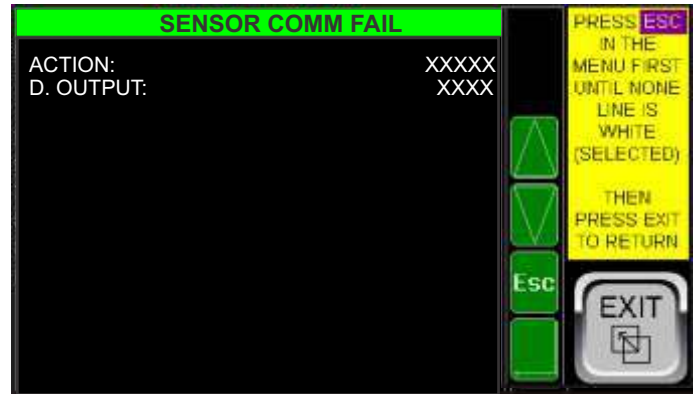

### M08.6-SENSOR COMM FAIL

This fault will occur if the sensor network presents a fault, which is shown on the main screen (Ms6) as already described in the section corresponding to this screen and whose fault type is shown on this screen.

**08.6.1- Action:** (None, Log, Alarm). Choose the desired option. Note that there is no Trip option because this is not an important fault that could trip the system, and therefore can be fixed.

**08.6.2- Aux Output:** (None, D.O.3, D.O.4, EB1: Aux1 to EB8: Aux8). Choose the desired option.

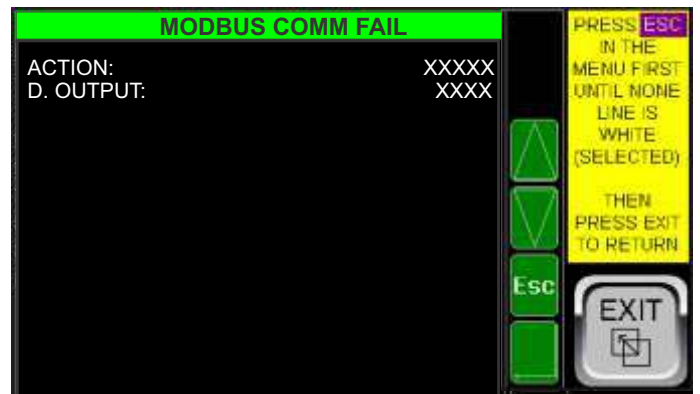

### M09.7-MODBUS COMM FAIL

This fault will occur if the sensor network presents a fault, which is shown on the main screen (Ms6) as already described in the section corresponding to this screen and whose fault type is shown on this screen.

**08.7.1- Action:** (None, Log, Alarm). Choose the desired option. Note that there is no Trip option because this is not an important fault that could trip the system, and therefore can be fixed.

**08.7.2- Aux Output:** (None, D.O.3, D.O.4, EB1: Aux1 to EB8: Aux8). Choose the desired option.

# PROGRAMING

## 21- MENU



### M08.8- DIFFERENTIAL

This fault will occur if the differential fault is programmed to be executed and the temperature rises in relation to the first measurement as programmed.

**08.8.1- Execute Diff:** (Yes, No). Choose «Yes» to activate this protection or «No» to not activate it.

**08.8.2- Alarm Level:** Enter the Alarm level as a percentage of the initial reading.

**08.8.3- Trip Level:** Enter the Trip level as a percentage of the initial reading.

**08.8.4- Alarm Action:** (None, Log, Alarm). Note that there is no Trip option.

**08.8.5- Trip Action:** (None, Log, Trip). Note that there is no Alarm option which will occur together with the Trip option.

**08.8.6- Warm Up Hours:** Enter the warm up time in hours required to take the first measurement. The first measurement is taken with the system warmed up and stabilized. In environments with high variations in ambient temperature, do not choose an alarm or trip level that is too tight, taking into account the variation in ambient temperature as well.

**08.8.7- Restart Period:** (0=No) Enter the period for the automatic restart of the function, i.e., for taking a new measurement. The restart can also be manual, at any time, performed in item 08.7.9 below. Note that if zero is entered, it is equivalent to never performing the automatic restart.

**08.8.8- Aux Output:** (None, D.O.3, D.O.4, EB1: Aux1 to EB8: Aux8). Choose the desired option.

**08.8.9- Restart Differ:** This item directs you to the screen that will perform the restart of the differential (shown below), performing a new initial reading when the action is confirmed in the «Proceed?» button with the «Yes» option.

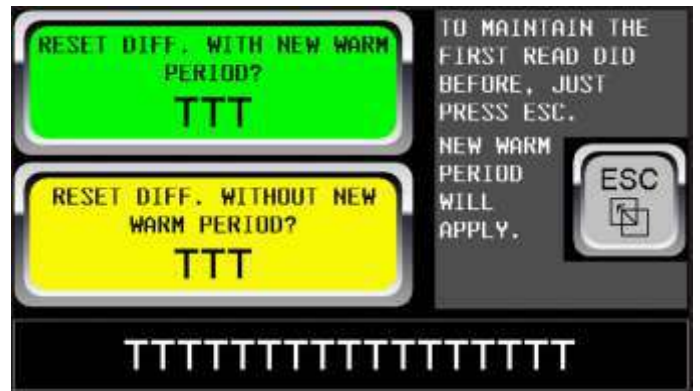

### 08.8- RESTART DIFFERENTIAL:

If the green button is pressed, there will be a new reading of the initial reference temperatures for the differential after the new heating period (Warm) has been counted.

If the yellow button is pressed, there will be a new reading immediately, without the heating period. Only use the yellow button if you are sure that the system is at a stable temperature at the moment.]

This screen will also appear after the relay is switched off in a valid differential condition, i.e. with the indication «Valid» so that the operator can decide whether to continue with the data previously read and saved for the differential reference or to start the differential with a new reading.



### M08.9- OPERATING TIME

This fault will occur if the fault is programmed to be executed in «Action» and the On Time is greater than the programmed one. This fault is used to schedule any preventive maintenance on the system, although the Zyggot system itself does not require any preventive maintenance for at least 10 years.

**08.9.1- Action:** (None, Log, Alarm). Choose the desired option. Note that there is no Trip option.

**08.9.2- Hours:** Enter the number of On hours to activate this protection (max = 250000 h).

**08.9.3- Aux Output:** (None, D.O.3, D.O.4, EB1: Aux1 to EB8: Aux8). Choose the desired option.

# PROGRAMING

## 21- MENU

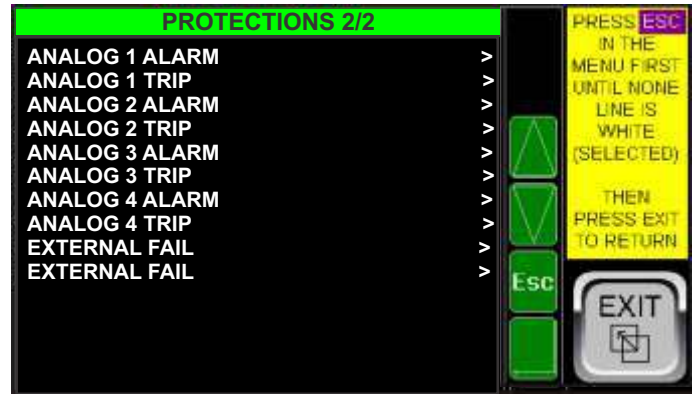

### M08.10-GROUP

This menu is subdivided into 5 (Group 1 to Group 5). Only the programming of group 1 will be detailed. The others are identical.

### M08.12 - PROTECTIONS 1/2

In this menu, the parameters related to the protections shown above will be programmed. The numbering of the submenus will follow the sequence of menu 7- Protections

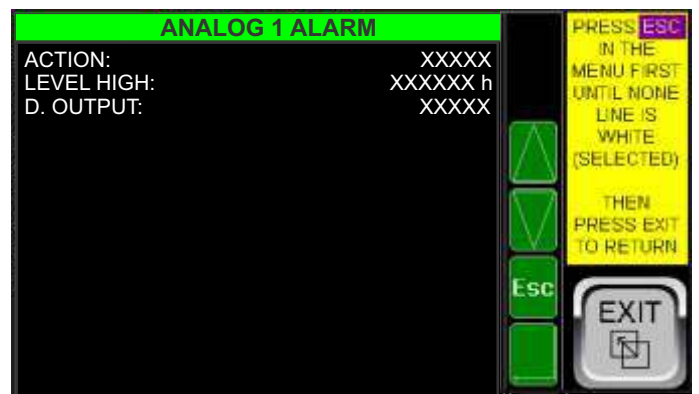
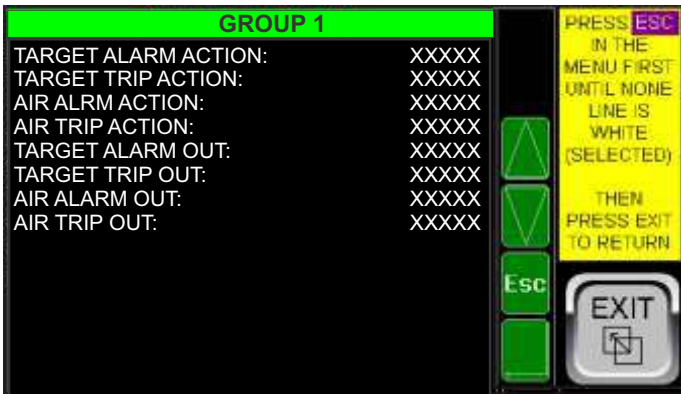

### M08.11-GROUP 1

This fault will occur if any of the sensors assigned to this group are in Alarm or Trip condition.

**08.11.1- Target Alarm Action:** (None, Log, Alarm). Note that there is no Trip option.

**08.11.2- Target Trip Action:** (None, Log, Trip). Note that there is no Alarm option which will occur together with the Trip option.

**08.11.3- Air Alarm Action:** (None, Log, Alarm). Note that there is no Trip option.

**08.11.4- Air Trip Action:** (None, Log, Trip). Note that there is no Alarm option which will occur together with the Trip option.

**08.11.5- Target Alarm Out:** (None, D.O.3, D.O.4, EB1: Aux1 to EB8: Aux8). Choose the desired option.

**08.11.6- Target Trip Out:** (None, D.O.3, D.O.4, EB1: Aux1 to EB8: Aux8). Choose the desired option.

**08.11.7- Air Alarm Out:** (None, D.O.3, D.O.4, EB1: Aux1 to EB8: Aux8). Choose the desired option.

**08.11.8- Air Trip Out:** (None, D.O.3, D.O.4, EB1: Aux1 to EB8: Aux8). Choose the desired option.

### M09.13-ANALOG 1 ALARM

This fault will occur if the fault is programmed to be executed in «Action» and the value of analog input 1 exceeds the programmed level.

**08.12.1- Action:** (None, Log, Alarm). Choose the desired option. Note that there is no Trip option.

**08.12.2- Level High:** Enter the level in % of full scale.

**08.12.3- D. Output:** (None, D.O.3, D.O.4, EB1: Aux1 to EB8: Aux8). Choose the desired option.

**M8.14-ANALOG 2 ALARM** - same as M9.13

**M8.15-ANALOG 3 ALARM** - same as M9.13

**M8.16-ANALOG 4 ALARM** - same as M9.13

# PROGRAMING

## 21- MENU



### M09.17-ANALOG 1 TRIP

This fault will occur if the fault is programmed to be executed in «Action» and the value of analog input 1 exceeds the programmed level.

**09.17.1- Action:** (None, Log, Alarm). Choose the desired option. Note that there is no Alarm option which will occur together with the Trip.

**09.17.2- Level High:** Enter the level in % of the full scale.

**09.17.3- Aux Output:** (None, D.O.3, D.O.4, EB1: Aux1 to EB8: Aux8). Choose the desired option.

**M9.18-ANALOG 2 TRIP** - same as M9.17

**M9.19-ANALOG 3 TRIP** - same as M9.17

**M9.20-ANALOG 4 TRIP** - same as M9.17

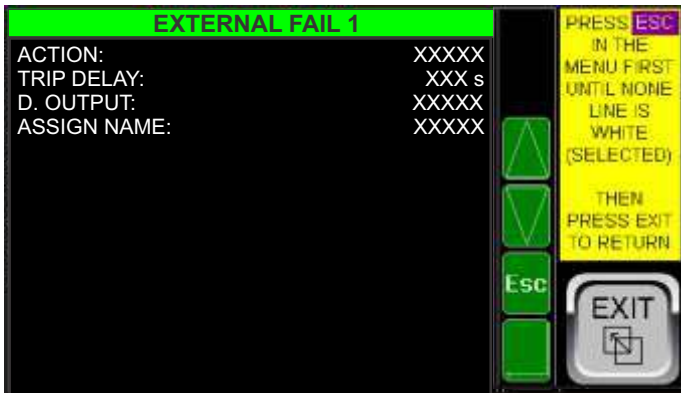

### M09.21-EXTERNAL FAIL 1

This fault will occur if the fault is programmed to be executed in «Action» and the corresponding digital input becomes active.

**09.21.1- Action:** (None, Log, Alarm, Trip). Choose the desired option. Note that if there is no Alarm option, the Trip will not be activated, and if the Trip option is selected, the Trip output and the Alarm output will be activated if configured for this purpose. If «Log» is selected, only the fault will be logged on the Alarms and History screen, but the alarm or trip condition will not be activated.

**09.21.2- Trip Delay:** Delay time that occurs after the digital input becomes active and the fault is detected.

**09.21.3- Aux Output:** (None, D.O.3, D.O.4, EB1: Aux1 to EB8: Aux8). Choose the desired option. **09.21.4- Assign Name:** Enter the name of the Digital entry with up to 5 characters to facilitate its identification in the system.

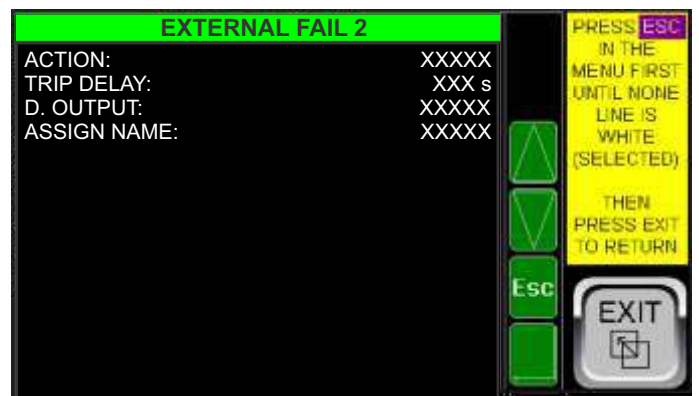

### M09.22-EXTERNAL FAIL 2

This fault will occur if the fault is programmed to be executed in «Action» and the corresponding digital input becomes active.

**09.22.1- Action:** (None, Log, Alarm, Trip). Choose the desired option. Note that if there is no Alarm option, the Trip will not be activated, and if there is a Trip option, the Trip output and the Alarm output will be activated if configured for this purpose. If «Log» is chosen, only the fault will be logged on the «Alarms» and «History» screens, but the alarm or trip condition will not be activated.

**09.22.2- Trip Delay:** Delay time that occurs after the digital input becomes active and the fault is detected.

**09.22.3- Aux Output:** (None, D.O.3, D.O.4, EB1: Aux1 to EB8: Aux8). Choose the desired option. **09.22.4- Assign Name:** Enter the name of the Digital entry with up to 5 characters to facilitate its identification in the system.

# PROGRAMING

## 21- MENU



### M08.23- GATEWAY NOT PROGRAMED

This signal will occur if the Gateway is powered without being properly programmed by the Zyggot relay or by the PC software.

**09.23.1- Action:** (None, Log, Alarm). Choose the desired option. Note that there is no «Trip» option because it is not a critical failure.

**09.23.2- D. Output:** (None, D.O.3, D.O.4, EB1: Aux1 to EB8: Aux8). Choose the desired option.

### M08.24- GATEWAY COMMUNICATION FAIL

This flag will occur if the relay is unable to communicate with the Gateway.

**09.24.1- Action:** (None, Log, Alarm). Choose the desired option. Note that there is no «Trip» option because it is not a critical failure.

**09.24.2- D. Output:** (None, D.O.3, D.O.4, EB1: Aux1 to EB8: Aux8). Choose the desired option.

### M08.25- ARC SENSOR NOT RESPONDING

This signal will occur if the Gateway is unable to communicate with one or more arc sensors.

**09.25.1- Action:** (None, Log, Alarm). Choose the desired option. Note that there is no «Trip» option because it is not a critical failure.

**09.25.2- D. Output:** (None, D.O.3, D.O.4, EB1: Aux1 to EB8: Aux8). Choose the desired option.

### M08.27- ARC FLASH

This signal will occur if one or more arc sensors detect the occurrence of an electric arc.

**09.27.1- Action:** (None, Log, Alarm, Trip). Choose the desired option. **ATTENTION:** Note that there are no options for «None», «Log» and «Alarm» since the Gateway already has a dedicated «Trip» output, which should always be used to trip the circuit breaker that cuts off the system power supply. This Arc Flash output, via the relay, can be used, for example, to send a signal to other systems or to trip auxiliary systems.

**09.27.2- D. Output:** (None, D.O.3, D.O.4, EB1: Aux1 to EB8: Aux8). Choose the desired option. **NOTE:** These outputs are auxiliary, in case you want to duplicate the trip output, for example, since the Gateway already has a dedicated Trip output.

### M08.28- CHAIN INPUT

This signaling will occur if one or more arc sensors detect the occurrence of an electric arc.

**08.28.1- Chain Input Action:** (None, Arc Flash, Alarm Relay, Trip Relay). Select the desired option. Select the desired option. If «Arc Flash» is selected, its activation will be treated as an Arc Flash occurrence, causing the activation of the Gateway trip output. If «Alarm Relay» is selected, it will only activate a corresponding alarm indication on the Zyggot relay. If «Trip Relay» is selected, its activation will cause a Trip and Alarm fault on the Zyggot relay, activating its Trip and Alarm output contacts. Note that these activations are slow and should not be confused with the Gateway's dedicated trip output, which will occur in less than 250 us.

**08.28.2- D. Output:** (None, D.O.3, D.O.4, EB1: Aux1 to EB8: Aux8). Select the desired option. **NOTE:** These outputs are auxiliary, in case you want to duplicate the trip output for example, as the Gateway already has a dedicated Trip output.

### M08.29- REMOTE 1 OUTPUT MODE

This option can be used to activate the Gateway output 1 in case of any fault detected by the Zyggot relay. It depends on the programming of each relay fault.

**08.29.1- Remote 1 Output Mode:** (None, Alarm From Relay, Trip From Relay). Select the desired option. Select the desired option. If «Alarm From Relay» is selected, an alarm output from the Gateway will be activated by a command from the Zyggot relay in «Alarm» condition. If «Trip From Relay» is selected, a Trip output from the Gateway will be activated by a command from the Zyggot relay in «Trip» condition. Note that this action does not activate the Gateway's dedicated ultra-fast Trip output, but rather Gateway output 1 if programmed to do so.

### M08.30- REMOTE 2 OUTPUT MODE

This option can be used to activate Gateway output 2 in the event of any fault detected by the Zyggot relay. It depends on the programming of each relay fault.

**08.19.1- Remote 1 Output Mode:** (None, Alarm From Relay, Trip From Relay). Select the desired option. Select the desired option. If «Alarm From Relay» is selected, an alarm output from the Gateway will be activated by a command from the Zyggot relay in «Alarm» condition. If «Trip From Relay» is selected, a Trip output from the Gateway will be activated by a command from the Zyggot relay in «Trip» condition. Note that this action does not activate the Gateway's dedicated ultra-fast Trip output, but rather Gateway output 2 if programmed to do so.



Pressing the «HELP» key displays 5 screens that can be scrolled through using the >> and << keys to see details of the arc system operation.

**Note:** The H5 screen is only available from Version V05.71 onwards and in the Multi Gateways version.

# PROGRAMING

## 21- MENU

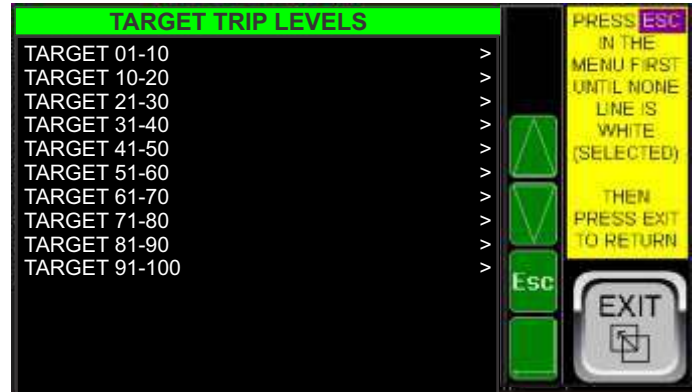

### M09- TARGET ALARM LEVELS

In these Submenus you can enter each Alarm temperature level for the target or edit the levels that were automatically set by the Group Programming submenu.

### M10- TARGET TRIP LEVELS

In these Submenus you can enter each Trip temperature level for the target or edit the levels that were automatically set by the Group Programming submenu.

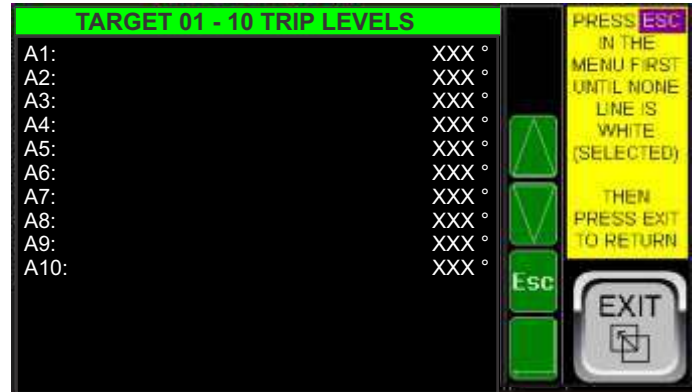
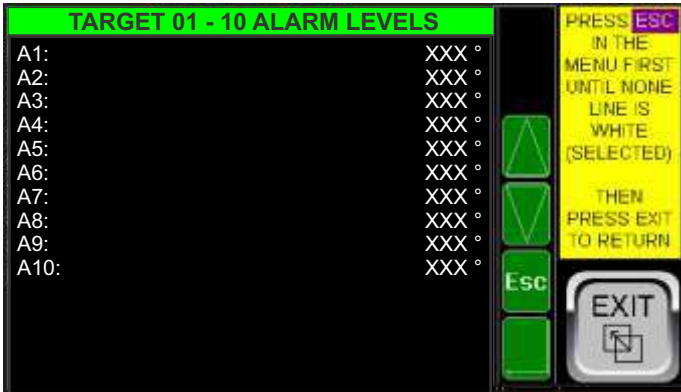

### M09.1- TARGET 01 - 10 ALARM LEVELS

**M09.1.1- A1 to A8** Enter or edit the level in degrees Celsius or Fahrenheit for the target alarm level.

### M10.1- TARGET 01 - 10 TRIP LEVELS

**M10.1 - A1 to A10** Enter or edit the level in degrees Celsius or Fahrenheit for the target alarm level.

- M09.2- TARGET 11 - 20 ALARM LEVELS
- M09.3- TARGET 21 - 30 ALARM LEVELS
- M09.4- TARGET 31 - 40 ALARM LEVELS
- M09.5- TARGET 41 - 50 ALARM LEVELS
- M09.6- TARGET 51 - 60 ALARM LEVELS
- M09.7- TARGET 61 - 70 ALARM LEVELS
- M09.8- TARGET 71 - 80 ALARM LEVELS
- M09.9- TARGET 81 - 90 ALARM LEVELS
- M09.10- TARGET 91 - 100 ALARM LEVELS

Same as M09.1.1 above

- M10.2- TARGET 11 - 20 TRIP LEVELS
- M10.3- TARGET 21 - 30 TRIP LEVELS
- M10.4- TARGET 31 - 40 TRIP LEVELS
- M10.5- TARGET 41 - 50 TRIP LEVELS
- M10.6- TARGET 51 - 20 TRIP LEVELS
- M10.7- TARGET 61 - 70 TRIP LEVELS
- M10.8- TARGET 71 - 80 TRIP LEVELS
- M10.9- TARGET 81 - 90 TRIP LEVELS
- M10.10- TARGET 91 - 100 TRIP LEVELS
- M10.11- TARGET 101 - 100 TRIP LEVELS

Same as M10.1.1 above

# PROGRAMING

## 21m- MENU



### M11- TRENDING CONFIG

This menu allows you to configure the parameters related to the curves (Plot) shown previously in this manual.

**11.1- Scale:** Enter the temperature scale equivalent to the full scale or 100% of the vertical axis of each Trending shown on screens T1 to T12. This number appears in the left corner of each screen from 1 to 12 of the curves.

**11.2- HMI Reset:** (Enable, Disable). If «Enable» is selected, the operator will be able to command the reset of the curves on the display of each one. If «Disable» is selected, the curves will not be reset.

**11.3- Enable Retentive:** (No, Yes). Enables or disables the recording of curves related to the T18 Screen Plot, as detailed in the operation screens section.

### M12- CLEAR DATA

This menu directs you, through items, to Clear screens (data reset).

**12.1- Clear History:** Where you can clear the fault and event report that is displayed on the HISTORY screen and that cannot be done directly on the screen, so that an operator who does not have the menu password can erase this data. It is recommended that only engineering personnel have access to the programming menu for this reason and also to avoid inadvertently changing important parameters.

**12.2- Clear Statistics:** Where you can reset the total number of Alarms and Trips that appear on the MS3 screen (Main Screen 3). The same observations regarding the password apply as in the item above.

### Tela Clear History



### Tela Clear Statistics



# PROGRAMING

## 16- MENU



### M13- BACKUP / RESTORE DATA

**M13.1- Enable Autorun:** Auto Run must be enabled as well as Auto Load if it is desired to have the Fail-Safe system operational. After Auto Load has been executed, if the relay detects that the program is missing or corrupted.

**M13.2- Enable AutoLoad:** Must be enabled in the same way as described above.

**M13.3- Flash Backup:** This submenu directs you to the screen below where you can clear the previously executed backup or perform a first or new backup of the entire RAM memory to the internal Flash memory. This internal backup is used in the event of a Fail-Safe action with Auto Load and Auto Run.

Only execute the Make Backup command after having programmed all the parameters and being sure that the relay is operating correctly and without active or uncleared faults on the alarm screen.

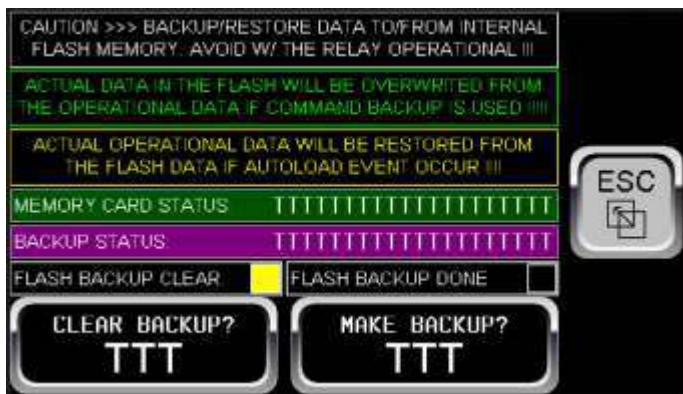

In addition to the Clear Backup and Make Backup buttons and the Cleared or Done indications, there is a memory card status field, as previously described, and a Backup Status field, with the messages described previously on the MS10 Screen, which can be: 1- STANDBY / 2- OK - PROCEED / 3- ERROR - CHECK CARD / 4- DONT BACKUP ON FAIL / 5- OK - DONE / 6- WRITING / 7- READING / 8- BUSY.

Note that the Clear Backup and / Make Backup command buttons are invisible if the conditions for these commands are not suitable at the time.

### M14.2- CLONE PARAMETERS

This submenu takes you to the Clone Parameters screen below.

**WARNING:** This action, if «Restore» is commanded, will overwrite all programming parameters with those contained in the memory card, in the specific file.

To use this function, a previously formatted memory card, with a maximum of 32 Gb, must be inserted in the upper slot of the relay. You can command «Backup» to save a new file with the data or «Restore» to restore the same.

In this way, if several Zyggot V5FTA THM+ARC Relays are used with the same programming, simply program one of them and clone the data in the other relays.

This action does not save or restore the programming password, which is in fact one of the parameters.

On the screen below, you can see that there are two fields, one with the card status messages as described in the explanation of the Info 4 screen and another with the Backup status messages as described previously on the MS10 Screen, which are: 1- STANDBY / 2- OK - PROCEED / 3- ERROR - CHECK CARD / 4- DONT BACKUP ON FAIL / 5- OK - DONE / 6- WRITING / 7- READING / 8- BUSY.

Note that the Backup and Restore command buttons are invisible if the conditions for these commands are not suitable at the time.

**Note:** Unlike the Flash Backup command, which copies the entire RAM memory to a non-volatile internal memory, the Clone Parameters command described here only saves the values of the parameters entered in the programming menu and serves as documentation to be saved, such as possible restoration of parameters to a previous condition when changes are made to the programming or, as already mentioned, cloning the same parameters in other relays of the same plant, for example.

To clone the parameters to other relays, copy the «Datacard» file from the memory card of the relay that generated the file to be cloned to the cards of the other relays onto a computer and then run the Restore command on each of them. Attention: In this case, be careful not to run the Backup command on the other relays before running the Restore command.

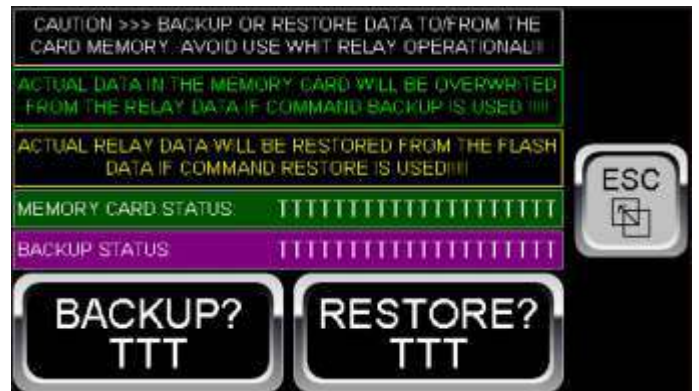

# PROGRAMING

## 21- MENU

### M16-ETHERNET

The ZYGGOT V5FTA Relay has **ETHERNET** communication and can be accessed from anywhere on the planet. Several communication protocols are incorporated, and the user simply needs to define the communication parameters in the programming screens below and use it.

For example, it is possible to obtain all temperature readings and flag statuses from a computer or mobile device or even interface with a DCS system anywhere, as long as there is access to Ethernet and the relay is connected to a local LAN network with access to an external WAN network and the addresses programmed in the relay are known.

It is possible to perform remote parameterization of the relay if necessary, such as alarm and trip levels, etc.

It is also possible for the manufacturer to perform eventual firmware updates remotely, if necessary.

#### The available protocols are:

**ICMP** - Internet Control Message Protocol.

**SRTP** - Service Request Transport Protocol.

**TCP/IP** - Transmission Control Protocol (Modbus TCP Server or Modbus Slave).

**ETHERNET/IP** - Internet Protocol (Ethernet IP Server).

**FTP** - File Transfer Protocol

**HTTP** - Hypertext Transfer Protocol.

**ASCII Over TCP/IP** - ASCII Transmission Control Protocol.

**NTP** - Network Time Protocol.

This manual does not intend to cover each protocol in depth. It is up to the user to know the protocol they intend to use.

Below is a brief description of each Protocol and their limitations in this application.

**ICMP - Internet Control Message Protocol.** Internet Control Message Protocol (ICMP) is a protocol that is part of the IP Protocol, defined by RFC 792. It is used to communicate network layer information, and its most common use is to provide error reports to the original source. Any computer that uses IP must accept ICMP messages. Although several tools are possible in this protocol, the Zyggot V5FTA relay only implements the Ping function, which can be used to check whether a device is responding to commands, i.e. is accessible on the network.

**SRTP - Service Request Transport Protocol.** Service Request Transfer Protocol (SRTP) is a GE Fanuc Automation protocol that allows a remote SRTP client to request services from an SRTP server. In this case, the ZYGGOT V5FTA relay acts as an SRTP server that responds to requests from one or more SRTP Clients.

Since SRTP was originally designed to support the services provided by the GE Fanuc Series 90, the ZYGGOT V5FTA SRTP protocol does not support all possible SRTP services. The ZYGGOT V5FTA Relay's implementation of SRTP is mainly limited to the services required for the exchange of registration data.

#### Configuration:

**Port Used:** 18245 TCP

**Maximum Number of Connections:** 16

The following SRTP service requests are supported by ZYGGOT V5FTA Relay.

0 PLC\_SSTAT  
 1 PLC\_LSTAT  
 4 READ\_SMEM  
 7 WRITE\_SMEM  
 33 CHG\_PRIV\_LEVEL  
 67 RET\_CONFIG\_INFO  
 79 SESSION\_CONTROL  
 97 PLC\_FEATURES\_SUPP

#### Tipos de Registro:

8 %R 16 bit  
 10 %AI 16 bit

12 %AQ 16 bit  
 16 %I 8 bit  
 18 %Q 8 bit  
 20 %T 8 bit  
 22 %M 8 bit  
 30 %S 8 bit  
 70 %I 1 bit  
 72 %Q 1 bit  
 74 %T 1 bit  
 76 %M 1 bit  
 84 %S 1 bit

TCP/IP - Transmission Control Protocol (Modbus TCP Server). The TCP/IP protocol is an acronym for Transmission Control Protocol, used to send and receive data on the web.

The TCP/IP protocol is the language of computers and specifies how data is exchanged over the Internet.

Most computers communicate using TCP/IP, providing end-to-end communications.

Highly scalable and widely used, this protocol requires little central management and was designed to make networks reliable, with the ability to automatically recover in the event of a device failure.

Each device has an IP address that identifies it, allowing it to communicate and exchange data with other connected devices.

#### Configuration:

**Port Used:** 502 TCP

**Maximum Number of Connections:** 16

**Note:** Modbus must be enabled on the Zyggot V5FTA relay.

# PROGRAMING

## 21- MENU

### ETHERNET/IP - Internet Protocol (Ethernet IP Server).

The Internet Protocol (IP) is the network layer communications protocol in the Internet protocol suite for relaying datagrams across network boundaries (Maintained by ODVA.org). Its routing function enables the interconnection of networks and essentially establishes the Internet.

IP is tasked with delivering packets from the source host to the destination host based solely on the IP addresses in the packet headers. To do this, IP defines packet structures that encapsulate the data to be delivered. It also defines addressing methods that are used to label the datagram with source and destination information.

**Configuration:**

**Ports Used: 44818 TCP or 2222 UDP**

**Maximum Number of Connections: 2**

**Start Send (Produced) Register = R2001 /// Words Count = 248**

**Start Received (Consumed) Register = R2501 /// Words Count = 199 ///**

**Status Register = R5513**

### FTP - File Transfer Protocol

This is the protocol that allows file transmission over the network. Through it, you can read and access files on the memory card inserted in the respective slot of the relay, where temperature readings, etc., are recorded. It is a standard/generic protocol that is independent of hardware for transferring files and is also a transfer program.

Data transfer in computer networks usually involves transferring files and accessing remote file systems (with the same interface used for local files). FTP is based on TCP, but predates the TCP/IP protocol stack, and was later adapted to it. It is the standard for transferring files.

**Configuration:**

**Ports Used: 20 and 21 TCP**

**Maximum Number of Connections: 4**

**User Name 1 (Read Only) = Z\_FTP\_USER /// Password = 899468 ///**

**User Name 2 (Read / Write) = Z\_FTP\_VRX /// Password = xxxx**

### HTTP - Hypertext Transfer Protocol.

The Hypertext Transfer Protocol is a communication protocol (at the application layer according to the OSI Model) used for distributed and collaborative hypermedia information systems. It is the basis for data communication on the World Wide Web.

Hypertext is structured text that uses logical connections (hyperlinks) between nodes containing text. HTTP is the protocol for the exchange or transfer of hypertext.

**Configuration:**

**Port Used: 80 TCP**

**Maximum Number of Connections: 1**

**User Name: = ZYGGOT\_WS**

**Password: 9387**

### ASCII Over TCP/IP - ASCII Transmission Control Protocol.

The ASCII Transmission Control Protocol, or ASCII TCP, is a query/response/question-and-response communication protocol in which a host PC uses ASCII characters to send commands to a device and receive responses from the device.

This protocol is designed to send and receive ASCII data over the Zyggot Relay's Ethernet port. The Relay acts as a server when using this protocol.

**Configuration:**

**Port Used:** Entered in Configuration.

**Tx Trigger: %M100 (transmits 500 Bytes when set = 1**

**Tx Bytes (8 bits) 500 Bytes (250 Words)** in the sequence Bytes 1 and 2 form Word 1 containing the temperature of Target 1, Bytes 2 and 3 containing the temperature of Target 2 and so on until completing 100 sensors, when the Air temperatures of Sensor 1, Sensor 2 etc. are completed until completing 100 sensors, therefore completing 400 Bytes (200 Words).

**Rx Copy Trigger: %M99** (copies 504 Bytes (252 Words) when set = 1 for the alarm and Trip parameters. Before being set, the user must transmit all the Bytes already configured as half a Word each, referring to the integer value of the alarm levels for each sensor.

**Rx Bytes (8 Bits) 504 Bytes (252 Words):** The first 500 Bytes must form 250 Words referring to the target alarm levels for 100 sensors, then Trip levels for 100 sensors and the last 4 Bytes must form the 2 words referring to the alarm and trip levels for all sensors (always the same for all).

**Maximum number of Connections: 1**

### NTP - Network Time Protocol.

NTP is a protocol for synchronizing equipment clocks based on the UDP protocol on port 123. It is used to synchronize the clock of a set of equipment and devices in data networks with variable latency. NTP allows you to keep the clock of an equipment synchronized with the correct time at all times and with great accuracy.

Configuration: Five NTP server addresses are predefined in Brazil. Upon request, we can define any other server worldwide.

The factory predefined servers are as follows:

- a.st1.ntp.br
- b.st1.ntp.br
- c.st1.ntp.br
- d.st1.ntp.br
- gps.st1.ntp.br

# PROGRAMING

## 21- MENU

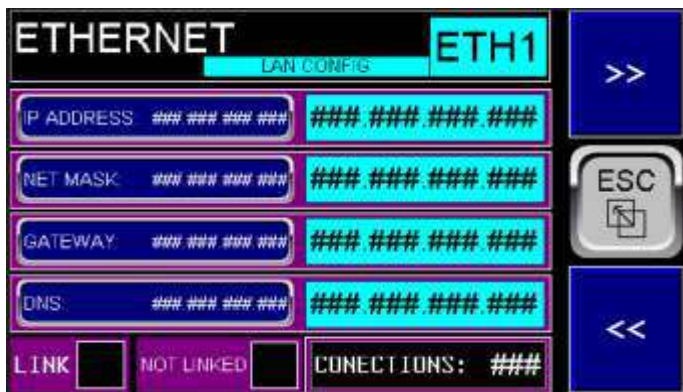

**M14A- ETHERNET - LAN CONFIG**

**M14A.1- IP ADDRESS:** Enter the address of the Zy6got V5FTA relay on the LAN network.  
**M14A.2- NET Mask:** Enter the number corresponding to the network mask. Normally 255.255.255.0  
**M14A.3- Gateway:** Enter the number corresponding to the Gateway if necessary. If not necessary, leave it at 0.0.0.0  
**M14A.4- DNS:** Enter the address of the Domain Name Server if necessary. If not used, leave it at 0.0.0.0  
 This screen also shows whether the Ethernet cable is connected or not and the number of connections. Note: the number of connections may eventually show «zero» even though it is connected if the transmissions are not repetitive and because it is very fast, there is not enough time to show it on the screen.



**M14C- ETHERNET - ICMP (PING)**

This screen, like the corresponding screen in the Report Menu, allows you to test whether a specific device on the network is responding, i.e., is active on the network.  
**M14C.1- PING ADDRESS:** Enter the address to perform the ping.  
**M14C.2- PING RESPOND TIME:** Shows the time in milliseconds that the device took to respond.  
**M14C.3- Tx and Rx:** Shows whether it is transmitting or receiving data.  
**M14C.4- PING TIMEOUT:** If the device does not respond in less than 1 second, it will indicate Timeout, i.e., it is not responding.  
**M14C.5- STAR and STOP:** Starts and stops the PING. When exiting the screen, a Stop is automatically given.

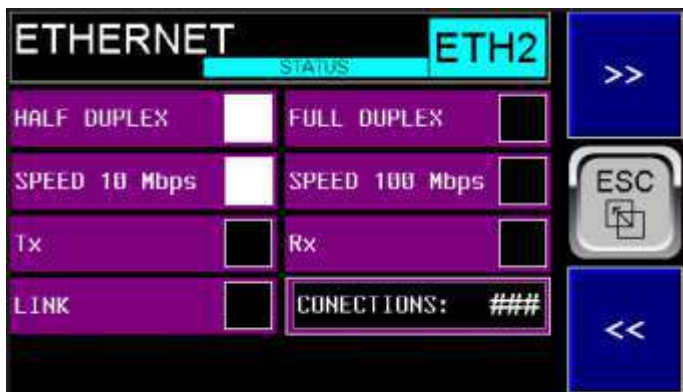

**M14B- ETHERNET - STATUS**

This screen only shows the various connection statuses, and does not have any fields to be entered.  
 The statuses shown are:  
**M14B.1- HALF DUPLEX or FULL DUPLEX:** Shows the connection mode.  
**M14B.2- SPEED 10 Mbps or 100 Mbps:** Shows the connection speed.  
**M14B.3- Tx and Rx:** Shows whether data is being transmitted or received.  
**M14B.4- LINK:** Whether the Ethernet cable is connected (Link) or not and the number of connections. Note: the number of connections may eventually show "zero" but it is connected if the transmissions are not repetitive and because they are very fast there is not enough time to show it on the screen.



**M14D- ETHERNET - TCP/IP PROTOCOL - MODBUS SLAVE**

This screen refers to the main protocol of the Zyggot V5FTA relay, which allows full Modbus operation, with all functionalities and valid addresses, as well as offsets, etc.  
 The SUPERGER program provided free of charge by Varixx allows, among other features, complete testing of the Modbus Over Ethernet connection with a computer connected to the Zyggot V5FTA relay.

# PROGRAMING

## 21- MENU



**M14E.6- PROGRAM PERMISSION:** It can be set to "Enabled" or "Disable" to allow or not programming of the relay parameters via Ethernet IP. Not enabled in this version so it is always set to "Disable"

**M14E.7- CONNECTED:** Indicates that the Ethernet connection is OK.

**M14E.8 - DATA VALID (at consumed section):** Informational only. For information purposes only on this screen. The corresponding word in the Ethernet IP server table (%R3328) have to be set to value 1, i.e. its bit 1 set when the data is valid to be write to the relay after a new writing page be selected. (Note enabled in this version. Only page 0 will be effective - see table).

**M15E.9 e M15E10 - CONNECT CLASS 3 e CONNECT CLASS 1:** Information Only.

### M14E-ETHERNET IP PROTOCOL

This screen refers to the Ethernet IP protocol. Unlike the TCP/IP (Modbus Over Ethernet) protocol described above, the data read and written will be transferred all at once, respecting the maximum number of Words, as described below.

**M14E.1- READING PAGE:** From 0 to 16 for reading until 128 words each page. Corresponds to record %R2927 in the Ethernet IP Server table.

**M14E.2- REGISTERS (PRODUCED):** For information purposes only. Always %R2801 to %R2928: will contain the several words with data according the table ETHERNET IP SERVER ahead in this manual.

**M14E.3- DATA VALID (at produced section):** For information purposes only on this screen. The corresponding word in the Ethernet IP server table (%R2928) will have the value 1, i.e. its bit 1 will be set when the data is valid after the page to be read has been changed. If there is no page change this bit will remain set indefinitely and if there is a page change it will briefly go to zero and then to 1 again when the data read has been changed.

**M14E.4- WRITING PAGE:** From 0 to 16 for writing until 128 words each page. Corresponds to register %R3226 in the Ethernet IP Server table. (Note enabled in this version. Only page 0 will be effective - see table).

**M14E.5- REGISTERS (CONSUMED):** For information purposes only. Always %R3201 to %R3328: will contain the several words to be write to relay with data according the table ETHERNET IP SERVER ahead in this manual. (Note enabled in this version. Only page 0 will be effective - see table).

# PROGRAMING

## 21- MENU

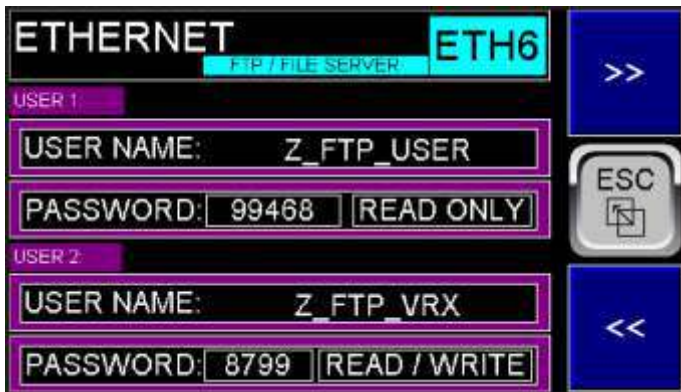

### M14F- ETHERNET - FTP PROTOCOL - FILE TRANSFER PROTOCOL

This screen refers to the protocol that enables reading and copying of files stored on the ZYGGOT relay memory card, allowing you to obtain historical data records of temperature readings, for example. To access any file on the card, you must know its name as recorded on the card. You must use the file name and its full path (with directories and subdirectories, if any), as in the examples below.

Assuming that the relay IP is **192.168.1.10** and you want to read the log.txt file, which is in the root directory of the card  
Then type in the search field:  
192.168.1.10/log.txt and press Enter.

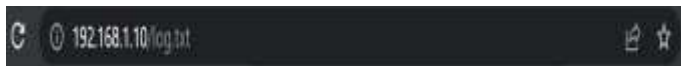

A screen will appear asking for your login and password. Once you have entered the correct login and password details, the file will be read and can be saved on your computer.

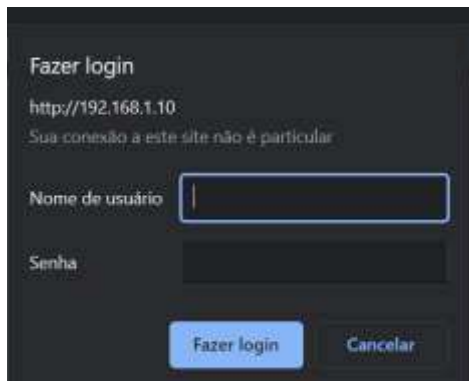

- M14F.1- **USER 1 - USER NAME:** Informational only. Always Z FTP\_USER.
- M14F.2- **PASSWORD:** Informational only. Always 99468
- M14F.3- **READ ONLY.** Informational only.
- M14F.4- **USER 2 - USER NAME:** Informational only. Always Z FTP\_VRX
- M14F.5- **PASSWORD:** Informational only. Always 8799.



### M14G- ETHERNET - HTTP PROTOCOL - WEB SERVER

This screen refers to the HTTP or HTTPS protocol that allows communication with Browsers using Hypertext Transfer Protocol.

- M14G.1- **USER NAME:** For information only. Always ZYGGOT\_WS.
- M154.2- **PASSWORD:** For information only. Always 9387



### M15H- ETHERNET IP

This screen refers to the ASCII OVER TCP/IP protocol.

- M14H.1- **BY NUMBER:** Enter the desired port.
  - M14H.2- **Tx BYTES:** For informational purposes only. Always 500 (250 Words).
  - M14H.3- **Tx TRIGGER (%M100):** When this flag is set to one, 500 Bytes will be transmitted in ASCII format, which must be combined (transformed into 200 16-bit Words that will contain the target and air temperatures of up to 100 sensors).
  - M14H.4- **Rx BYTES:** For informational purposes only. Always 506 (253 Words).
  - M14H.5- **COPY ENABLED:** Indicates whether copying of buffer records to real records is currently enabled. To indicate «enabled», the «Status Received» must be ok and there must be no «Rx Overflow» or «Socket» errors.
  - M14H.6- **STATUS RECEIVED:** Indicates that a successful reception of 504 Bytes (252 Words) occurred.
- After writing the data to be programmed, as per the table at the end of this manual, when setting the Flag corresponding to the «Copy Trigger» the data is copied to the corresponding parameters of the Zyggot V5FTA relay.

This data will be transferred to the parameters according to the table at the end of this manual.

# PROGRAMING

## 21- MENU

**M14H.6- COPY TRIGGER:** In this field choose the method to execute the Copy of the data from the Buffer region to the real parameter records. You can choose two options, namely: «%M99» or «BYTE T».

If %M99 is selected, at the end of data transmission to the relay, the %M99 flag must be set to validate the data, when the relay will copy the data to the real parameter registers and reset the %M99 flag. To set the %M99 flag, the normal TCP/IP protocol must be used.

If BYTE T (Byte Termination) is selected, the last bit of the second transmitted word (composed of Bytes 3 and 4) must be set. The first word (Bytes 1 and 2) must contain the number of bytes to be transmitted to the relay (always 506).

After writing the data to be programmed, starting from Byte 5 and 6, according to the table at the end of this manual, when setting the «Copy Trigger» Flag (%M99 or BYTE T) the data is copied from the internal buffer region to the real parameters of the Zyggot V5F relay.

**M14H.7- Rx OVERFLOW STATUS:** Indicates Overflow error in reception.

**M14H.8- Tx OVERFLOW STATUS:** Indicates Overflow error in transmission.

**M14H.9- SOCKET STATUS:** Indicates Socket error.

**IMPORTANT NOTE:** Always prefer to program the parameters directly on the relay or through the memory card, as described in this manual, for safety reasons. This protocol is accessible mainly because it allows you to read up to 250 target and air temperature readings. The part related to writing data is operational but should be avoided due to the possibility of programming errors and the possibility of even overwriting important data and rendering the relay inoperative, requiring factory maintenance. Therefore, either do not use the programming function using this method or use it with extreme caution.

It is more practical and simple to obtain temperature data, etc., using the TCP/IP Protocol, described above, where you can implement all Modbus over Ethernet communication and obtain all internal data from the Zyggot V5FTA Relay, in addition to writing all parameters. However, it is possible to use the ASCII Over TCP/IP protocol to obtain temperature data from the sensors, but the user will have to convert each 2 ASCII bytes into an Integer word, to obtain the numerical values for the temperatures according to the corresponding table at the end of this manual. In the same way, all alarm and trip levels for each sensor can be transferred at once up to 100 sensors and two more alarm and trip levels for air temperatures, but the user should also be responsible for transforming the data from Integer words into 2 bytes in ASCII. However, we do not recommend this method due to the risk of incorrect programming and obtaining erroneous data.

**Note that with a single programming of parameters in a relay, the identical programming can be replicated in other relays using the memory card.**

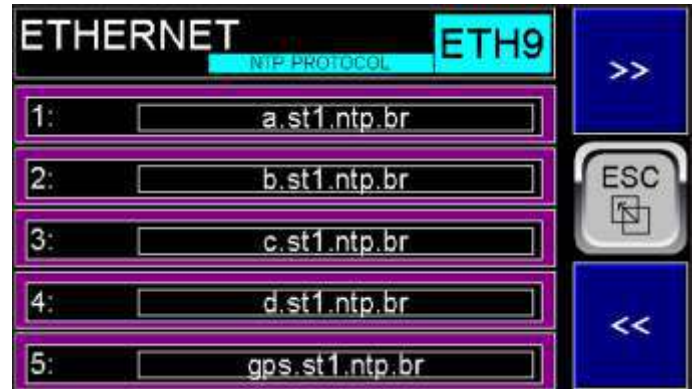

### M14I- ETHERNET NTP PROTOCOL

This screen refers to the Ethernet Network Time Protocol, through which devices can obtain exact time data from previously established servers. M16I.1 to M16I.7 - List of pre-established servers.

# TESTING THE ETHERNET CONNECTION

## USING A WINDOWS COMPUTER

A simplified way to test the **ETHERNET** connection is described below, using a simple executable software provided by Varixx (or using the **ZYGOT Thermography Supervisory 2.00** software (see the end of this manual), also provided free of charge by Varixx, or any similar program found on the world wide web). We will consider here the explanation using the executable **pyModbusTCPV5**

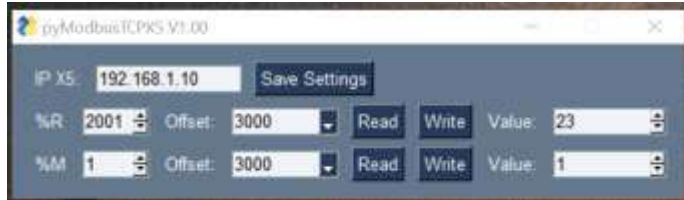

1- Initially connect the appropriate **RJ45** cable between the computer and the LAN port of the **Zyggot V5FTA** relay and open Windows Settings and select the Network and Internet option, which will open the properties screen that will contain content as below, among others.



2- Click on the "Change adapter options" option. The following screen will open, in which an unidentified Ethernet connection should appear, in addition to the other existing connections.



3- Right-click on the unidentified Ethernet connection. The following screen will open.



4- Double-click on the Internet Protocol Version 4 (TCP/IPv4) option. The following screen will open.



4- Enter an IP address that is different from your local network, for example, if your network is **192.168.0.1** and press OK, you must use a network that has a different third digit. For example, we use 192.168.1.11 and in the **pyModbusTCPV5** program we use 192.168.1.10, so the computer's address on the network will end in 11 and the **Zyggot V5FTA** relay will end in 10. At this point, the two devices should already be connected and exchanging data. On the Zyggot relay, on the Menu screen, choose option **16. REPORT** and then the **ETHERNET REPORT / STATUS** option. Then go to screen ER3 and activate the **START** option to test the connection with PING.



If the connection is OK, it will indicate a response time in the PING RESPONSE TIME field, which should be around 0.01 mS. If the connection is not OK, it will indicate PING TIMEOUT and the PING RESPONSE TIME field will be all +++++.

If the connection is OK, open the executable program **pyModbusTCPV5** and enter the chosen address, in this example **192.168.1.10**, and click Save Settings. Choose a register to be read, for example **%R2001**, which will contain the target temperature of Sensor 1, plus the necessary offset according to the Modbus tables in this manual, and click **Read**. The current temperature should appear in the **Value** field. In the same way, you can read flags of the **%M** type.

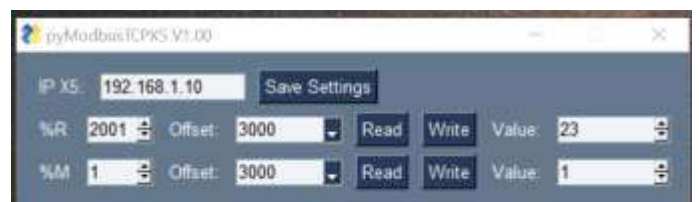

**Attention:** You can also write to the registers, but avoid this if you do not know that a particular register can be overwritten, as it may change the configuration parameters of the Zyggot relay.

# OPERATION

## TELA DE IDENTIFICAÇÃO

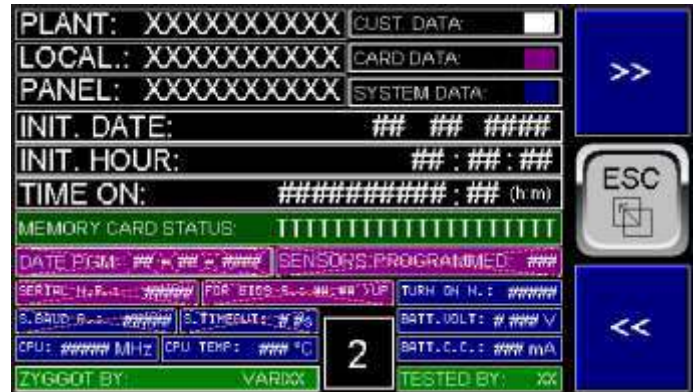

When energized, the relay will display the identification screen above and then perform a self-test, the results of which can be seen in the reports under the item «System Data».

Next, if the Start of Operation has already been commanded (See next page), the relay will display the initial screen below, the first of 3 that can be paged through using the >> and << keys. These same screens can be accessed at any time from the Main Menu, using the «Esc» key.

## INFORMATION SCREENS



The first information screen, above, shows the system identification, embedded software version, date and time of the internal real-time clock, communication status with the S. Comm OK or S. Comm Error sensors and some indications at the bottom that are repeated on several screens to facilitate the overview of the Alarm and Trip system, namely: FAIL, which will be filled in red if there is an active fault, TRGT which will be filled in white if there is a fault related to the target temperature, AIR, which will be filled in white if there is a fault related to the air temperature (sensor body), ALRM which will be filled in yellow if there is an active alarm output and Trip which will be filled in red if there is an active Trip output.

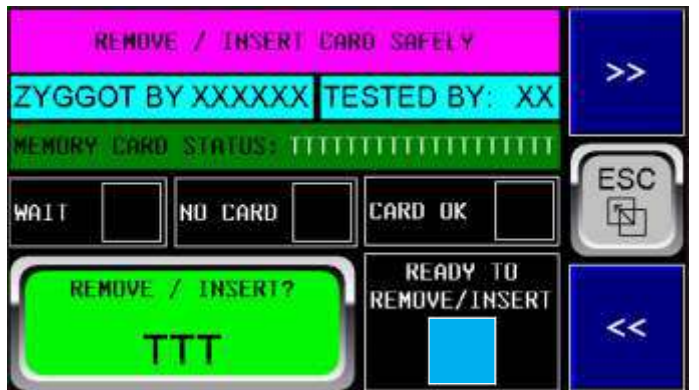

INFO screens 1 to 5 show system data and commands for inserting and removing the memory card safely, as previously described in the Main Screens section.

# OPERATION

## Normal Operation:

The operation is completely intuitive and can be easily learned in a matter of minutes.

It is understood that the sensors are already fully addressed by the program on the PC and correctly connected to the network as described elsewhere in this manual.

1- When the system is powered on, the start-up confirmation screen will appear only once, where the user confirms this by pressing the Proceed button, with the "Yes" option, and the Time ON counter will start.



2- After the procedure in item 1 or when the system is powered on, the main screen 1 (MS1) will appear a second time and the >> and << keys can be used to navigate through the 9 main screens (MS1 to Ms9), as already described. Pressing «ESC» takes you to the Main menu (below).

Before operating or activating the system, have the parameter values and options you wish to enter in the Programming menu at hand and carry out all the programming, without permanently connecting the Alarm, Trip or Auxiliary outputs to avoid an inadvertent tripping of the system.

The first thing to do in the first operation is to check whether all the sensors are flashing correctly and responding. You can also command the «Flash» of all of them at the same time or one at a time to check addresses and whether they are active on the network. This is done using the Flash key in the Main Menu below.



3- Depending on the type of operation «System Type» selected in the «Relay config» menu, one of the 3 menu screens above may appear respectively if «Thermo Only» mode is selected, or «Arc Flash Only» or «Thermo+Arc Flash».

Through these menus, you can access all the system screens in addition to the Programming Menu.

By pressing «ESC» on this screen, the first System Info screen appears (below) and you can navigate through the 5 screens with the keys already described above with the >> and << keys.

The 12. THM STATUS, 16. ARC FLASH and 18. ARC STATUS keys flash if there are corresponding active faults that have not been reset.

The «ESC» key returns you to the Main Menu above.



4- Using the corresponding keys, access all the Sub screens of each resource and interact or enter values on each screen, if necessary, as described in the Main Screens for Operation section, previously.

5- Note that the «Alarm» key may or may not have a flashing red outline. If it does, press it and enter the ALARM screen to acknowledge and eventually clear the fault indications.

6- Note that the relay can optionally be connected to the user's DCS system via a Modbus port as described. However, this connection is not necessary for the system to be fully protected.



# SCREEN FLOW

## 3. AIR

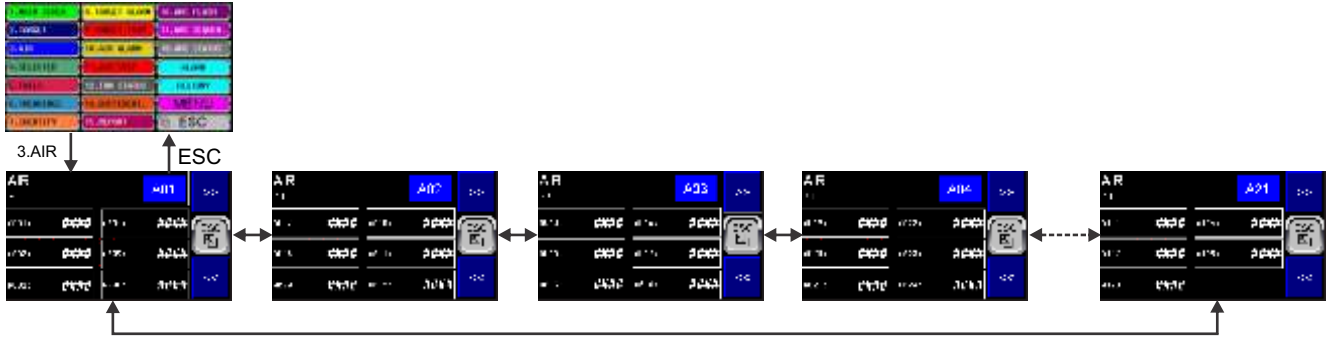

## 4. SELECTED

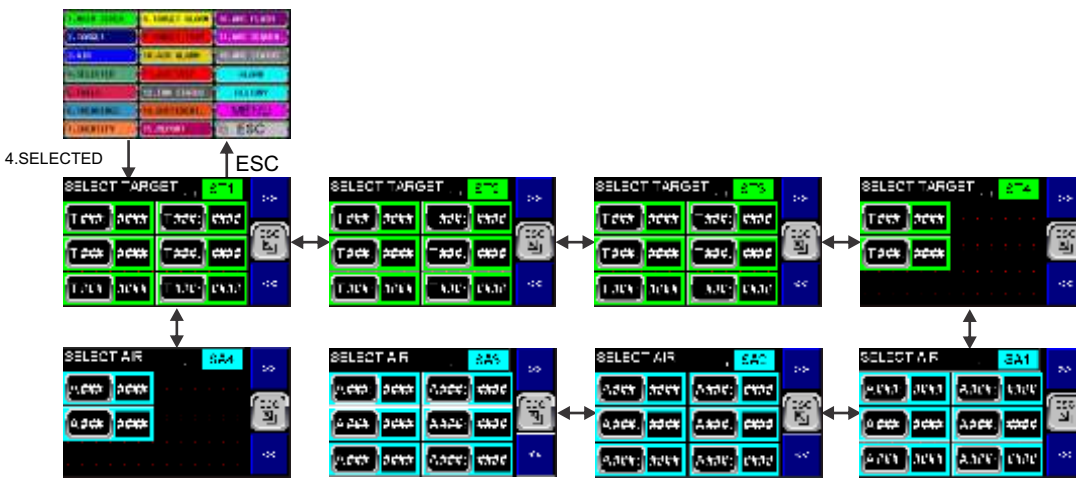

## 5. FAILS



## 19. ALARM

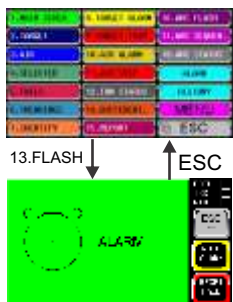

## 20. HISTORY





# SCREEN FLOW

## 10. AIR ALARMS

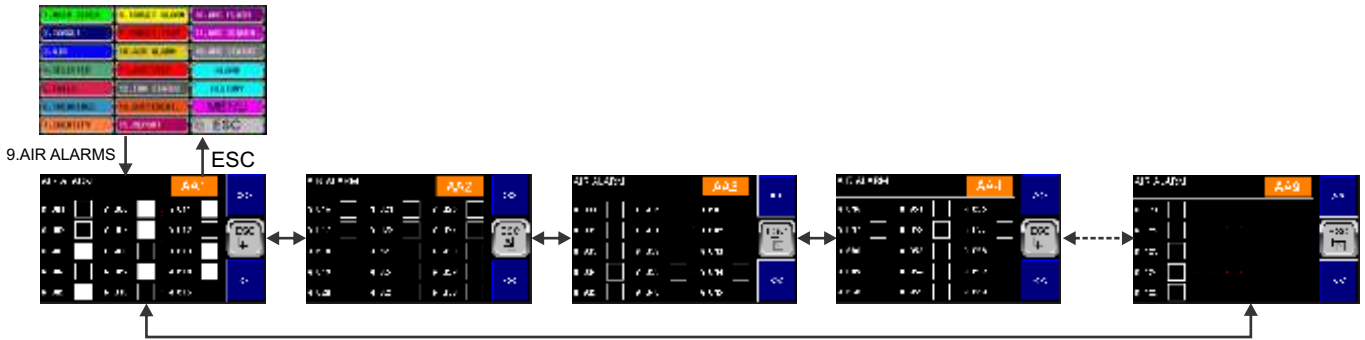

## 11. AIR TRIPS

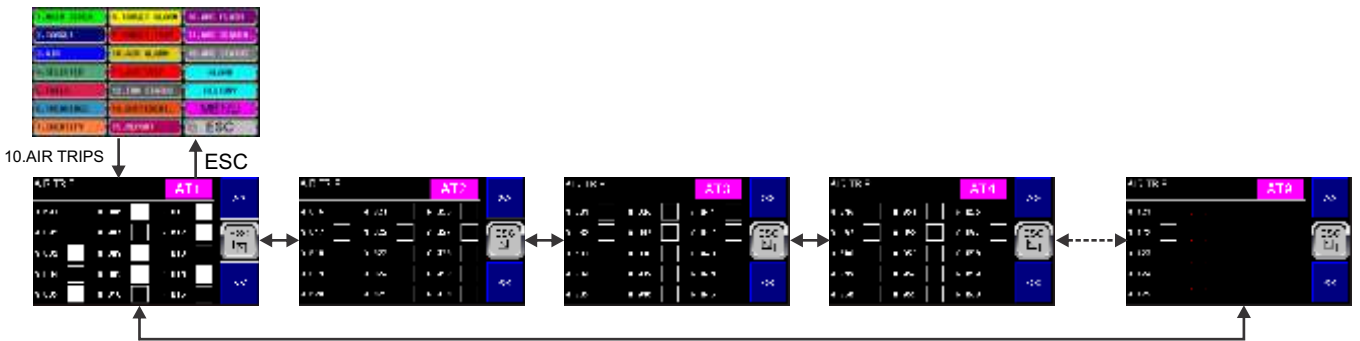

## 12. STATUS NOT RESPONDING THM

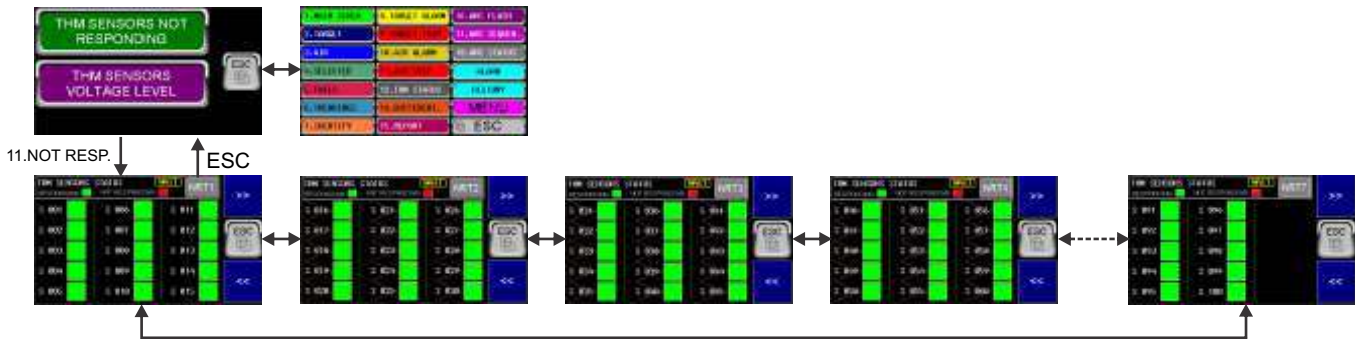

## 18. STATUS NOT RESPONDING ARC

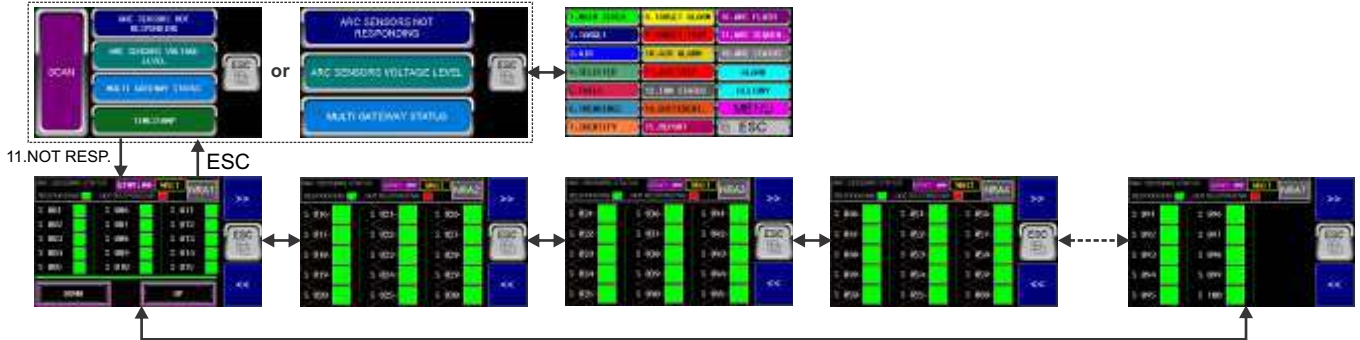

# SCREEN FLOW

## 12. STATUS VOLTAGE LEVEL THM



## 18. STATUS VOLTAGE LEVEL ARC



## 18. MULTI GATEWAY STATUS

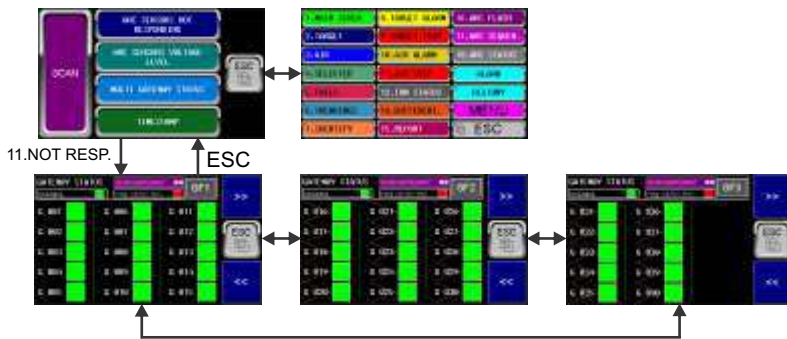

## 14. DIFFERENTIAL

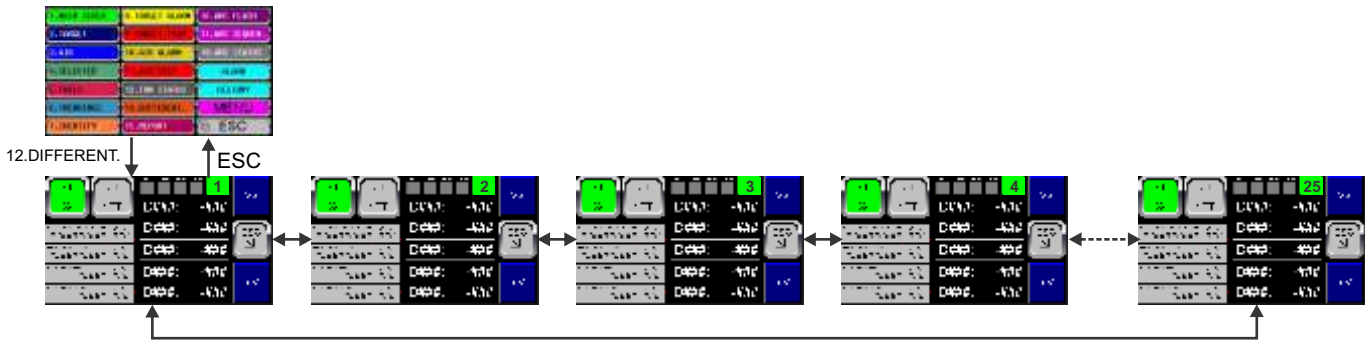

## 1/2 PROGRAM REPORT



ETHERNET REPORT / STATUS  
(see other page)

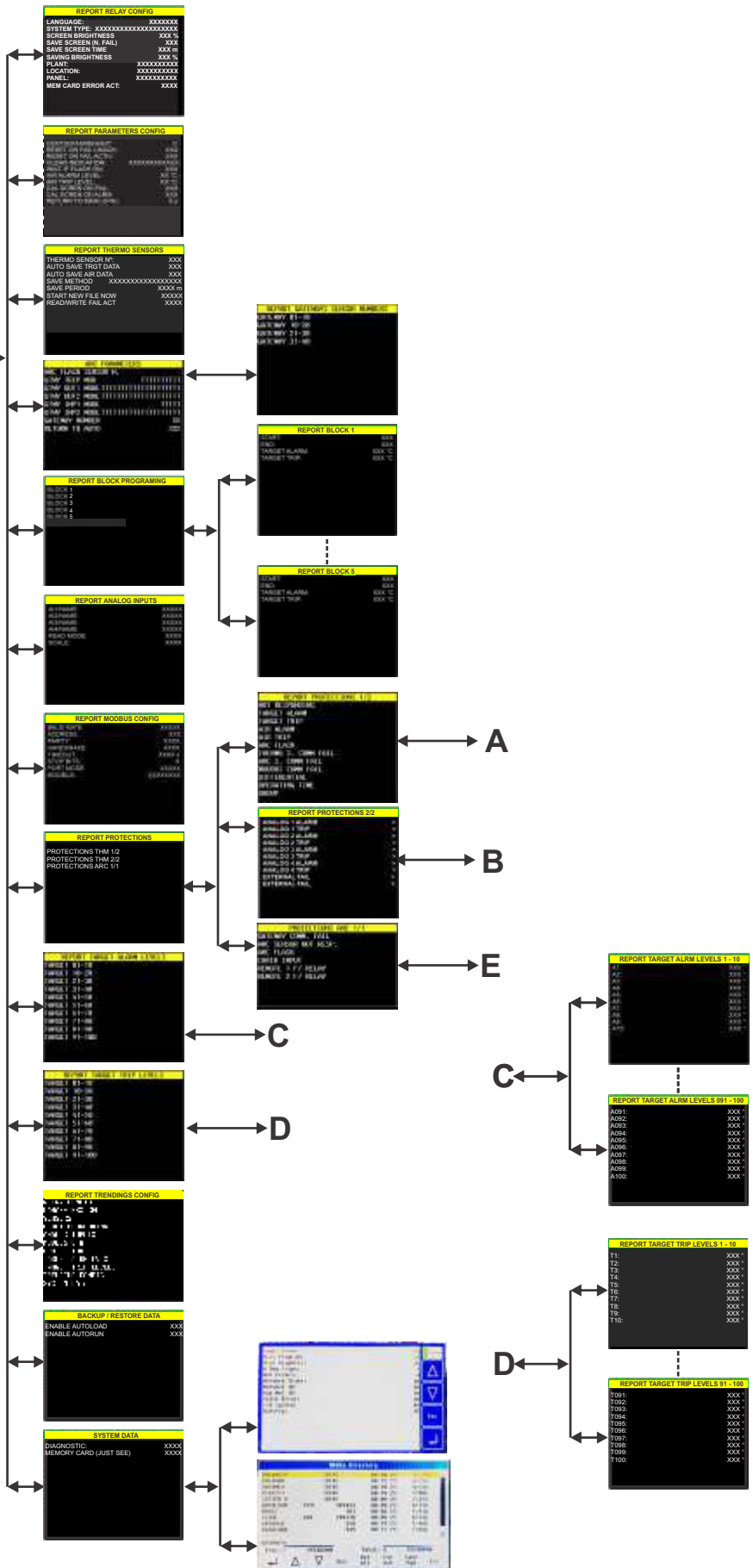

## 2/2 PROGRAM REPORT

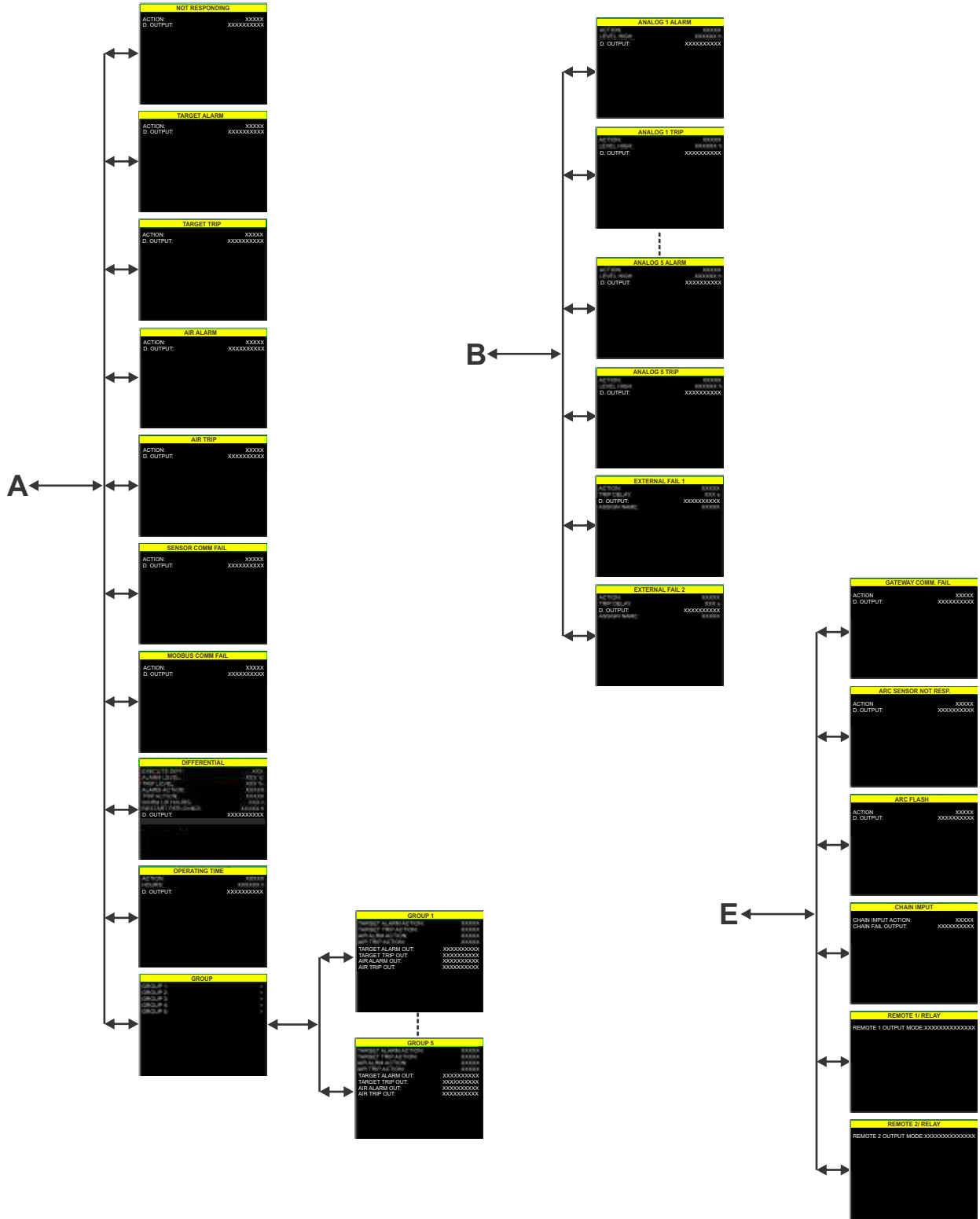

## 1/1 ETHERNET REPORT

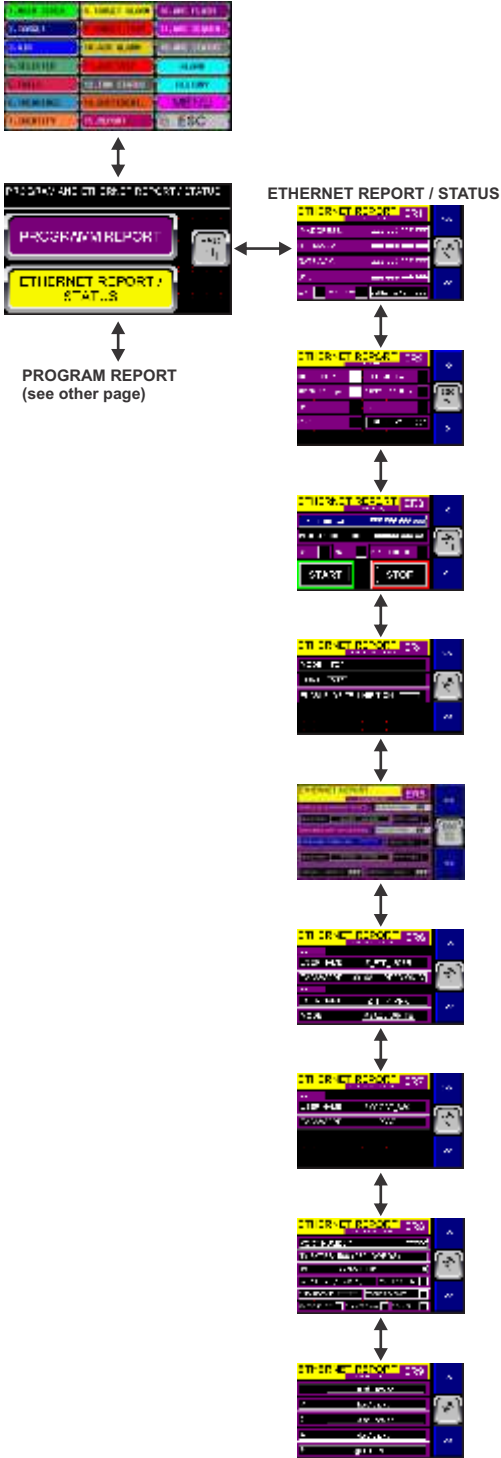

# SCREEN FLOW - PROGRAMMING

## PROGRAMMING MENU 1/2

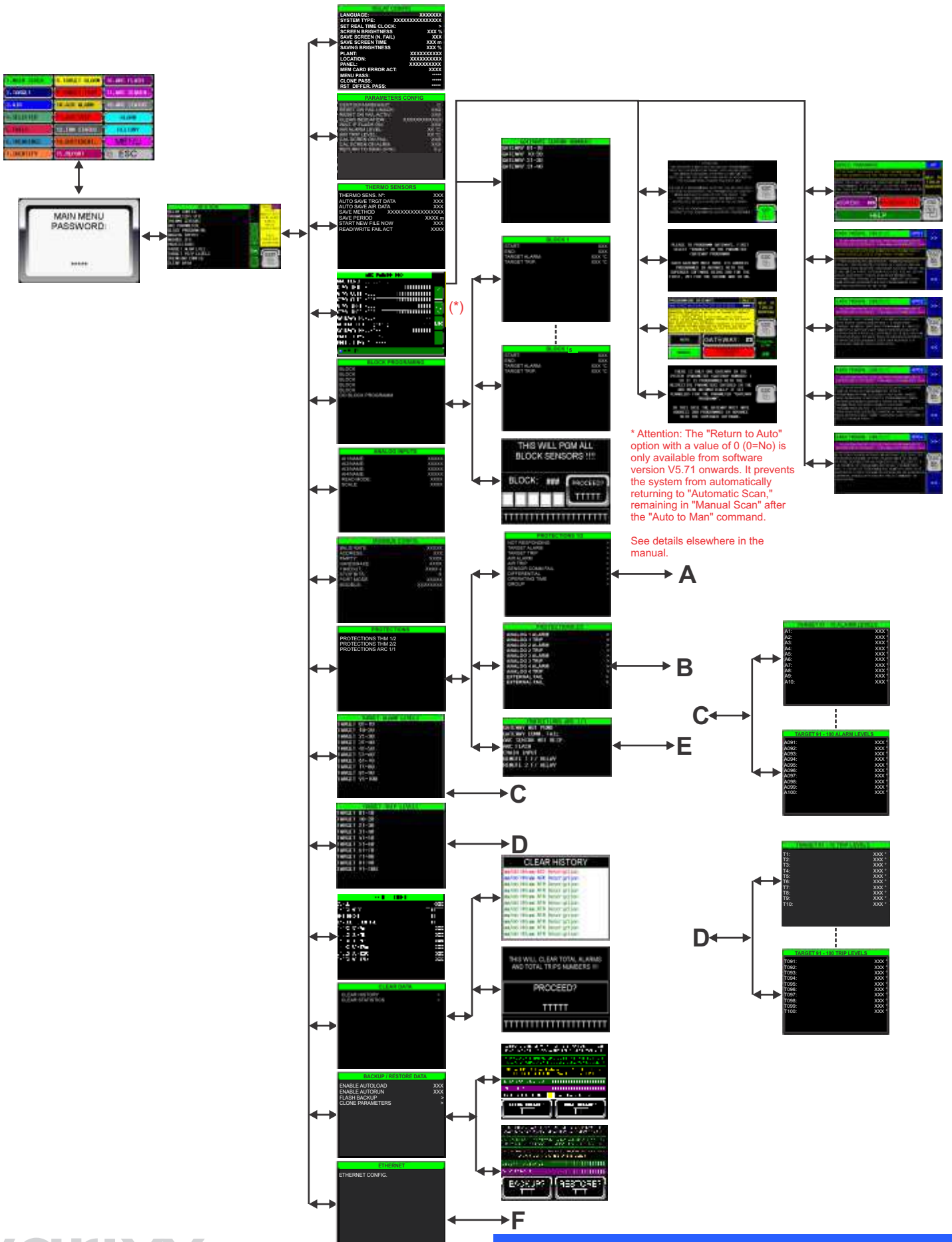

# SCREEN FLOW - PROGRAMMING

## PROGRAMMING MENU 2/2

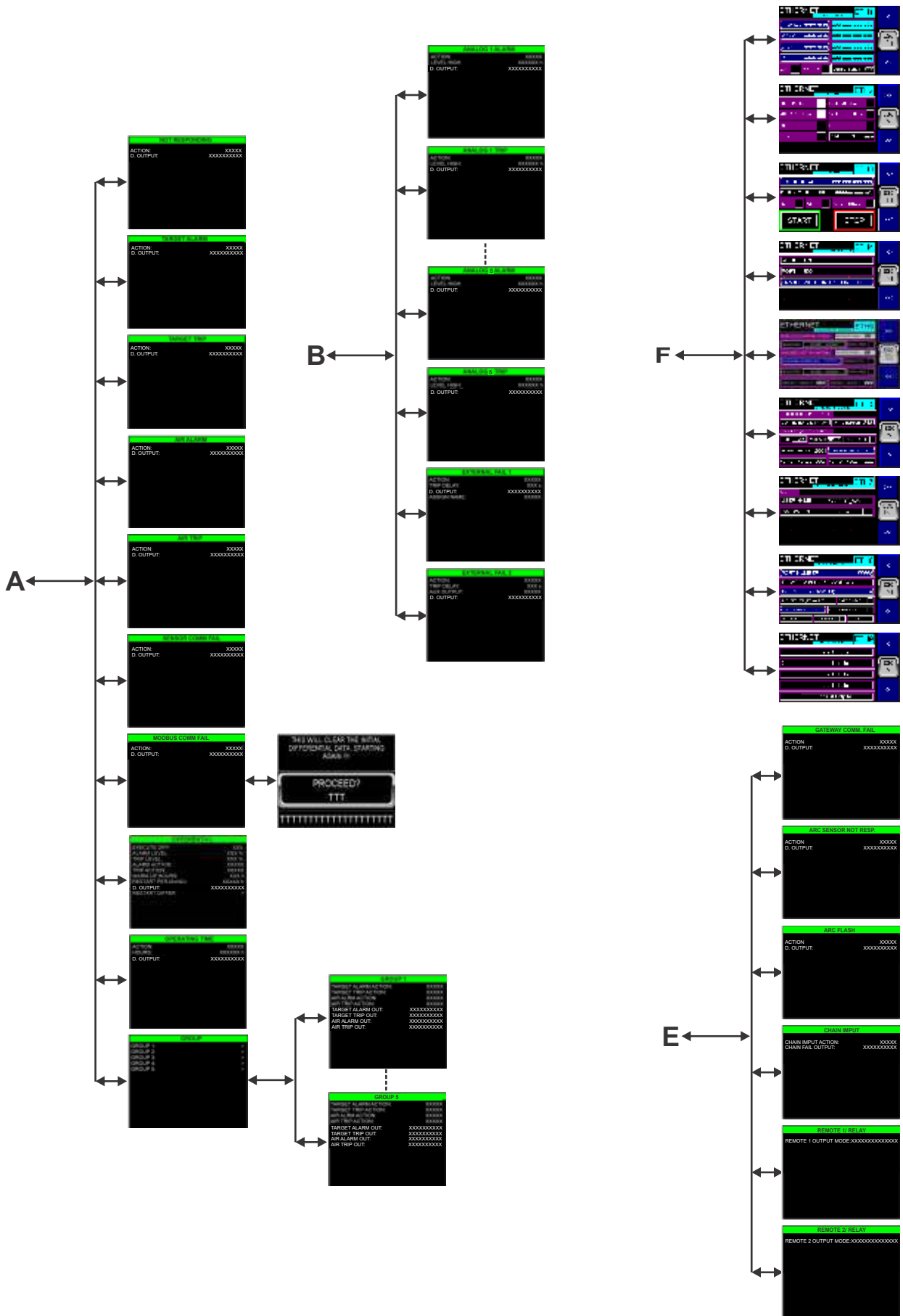

# COMPUTER PARAMETERIZATION

## ZYGOT SUPERGER

Zygot SuperGer is a configuration software for the Zygot family. The software is available free of charge on the Varixx website (<http://www.varixx.com.br>). The main screen of the program is shown on the side.

It is possible to configure the relay directly on the relay itself and also to perform the complete programming on a relay and to clone this relay to several others using a memory card or pen-drive, as explained previously. install the Superger Software on the Windows computer. All the files necessary to run it, including the «Runtime» files, are already included in the package, so no additional software is required. Once installed, it will be ready to run.



**Note:** With Zygot Superger you can easily clone the parameters of one relay to another (this can also be done via the uSD card in the case of the V5FTA model relay). To program a series of relays with the same parameters, simply save them (using the «Save» button in the Superger Software) and load the file later if necessary so that all the parameters are ready to «Send» to the relay.

1- The first step is to connect the relay. To do so, adjust the Modbus communication values on the relay and activate it in RS-232 mode. For details on how to activate Modbus, see the programming menu section. Use an RS-232 / RJ45 cable to connect the relay to a computer. You can also use the Ethernet port and do all the programming via Ethernet communication. In this case, program the correct address as programmed on the relay in the Ethernet programming section (Modbus TCP/IP).



2- The next step in the software is to choose the language and working mode on the system configuration screen:

Once you have chosen the language, choose the Zygot V5FTA system relay. Once you have chosen the language and the type of relay, by clicking on its image, select the correct parameters for your computer (COM port 1, COM2, etc.) and the parameters that were programmed on the screen regarding Modbus in the relay (For example: Address: 1, Baudrate: 19200, Timeout: 1000 mS, Parity: None or in the case of Ethernet communication the IP Address, for example: 192.168.1.1

Make sure that Modbus is in the «Active» condition in the relay. Normally, once any parameters related to Modbus in the relay have been changed, it is necessary to turn the relay off and on again for the changes to take effect, as these are parameters related to the relay BIOS.

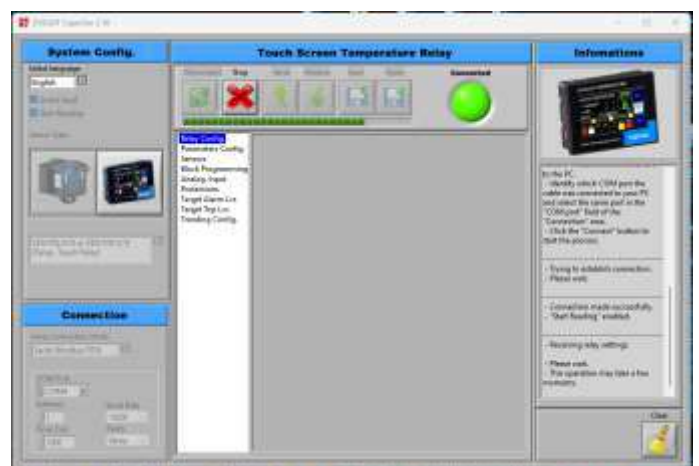

## ZYGOT SUPERGER

3- Once the parameters are correct and the relay has Modbus enabled, click on «**Connect**». The «**Connected**» indicator should light up and the current parameter reading bar will indicate that the parameters are being read on the relay. This is because you can save them and also indicate in red in each parameter window that is changed that the respective parameter will be changed if you use the «**Save**» key. You can also use the «**Receive**» key at any time to read the current parameters again. The window on the right shows all the LOG messages to facilitate any communication corrections.

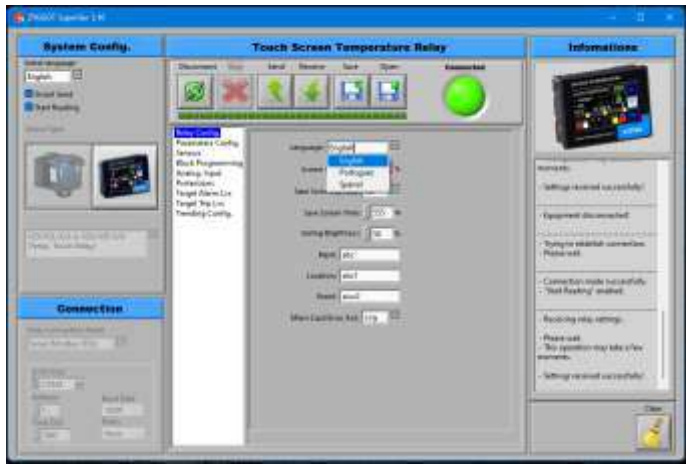

4- When the connection is made, the connected light will light up. If the initial reading box is checked, immediately after connecting to the relay, all the relay parameters will be transferred to the program. When finished, a success message will be displayed. Use the save and open buttons to save the information from a relay to a file on the computer and download the same information to other Zyggot relays.

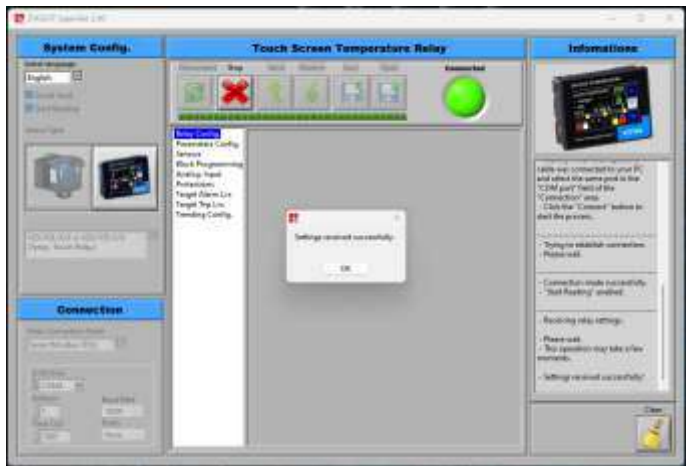

5- Você está pronto para programar todos os parâmetros nas telas subsequentes. Note que em cada janela disponível, ao ser alterado um parâmetro o mesmo fica em vermelho como alerta que ele será alterado ao enviar os dados para o relé.



# COMPUTER PARAMETERIZATION

## ZYGGOT SUPERGER

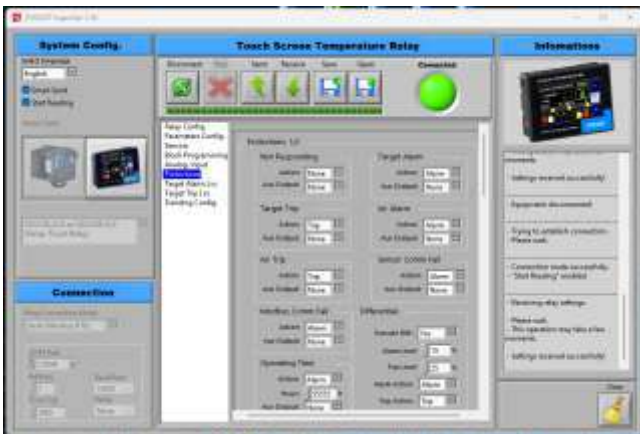

# COMPUTER PARAMETERIZATION

## ZYGGOT SUPERGER

6- Once the parameters are correctly programmed, they can be saved to a disk file for later use using the «**Save**» button. Previously saved files can also be loaded using the «**Receive**» button.

To send new data to the relay, use the «**Send**» button and at any time, the current relay parameters can be loaded using the «**Receive**» button.

When sending data to the relay, at the end of the transmission, a screen appears confirming that the data was transmitted successfully.



# SENSOR CONFIGURATION

## SOFTWARE GERENCIADOR ZYGGOT

Zyggot Manager is a configuration software that performs the addressing and testing of sensors. The software is available free of charge through the Varixx website (<http://www.varixx.com.br>).

Install the software on your Windows computer. All the files needed to run, including the "Runtime" files, are already included in the package, so no additional software is required. Once installed, it will be ready to run.

The program allows you to check and define important parameters before using the sensor on the network.

It defines the sensor address, the emissivity of the target considered by the sensor and the distance between the sensor and the target.

Note: When using Unidex tape (known and constant emissivity over the years), the emissivity value should be 0.95.

The user-friendly interface allows you to view the temperature of the target and the sensor body in several ways:

>> Through a graph, you can check the temperature measured over time. The scale ends can be changed with a mouse click.

>> Temperature readings are also displayed numerically.

Using an "analog" marker. The full scale value can be changed.

You can also send a command to make the sensor LED flash. Unlike when connected to the relay, the sensor remains on and does not flash when connected to the computer.

## Software Manager Main Window

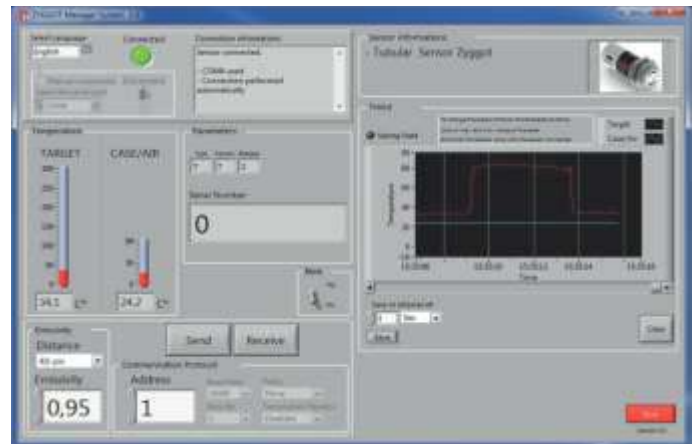

# ! CAUTION !

Do not connect the sensor to the PC while the other mini USB port is connected to the network.

NEVER connect two sensors to the PC simultaneously.

ALWAYS address one sensor at a time.

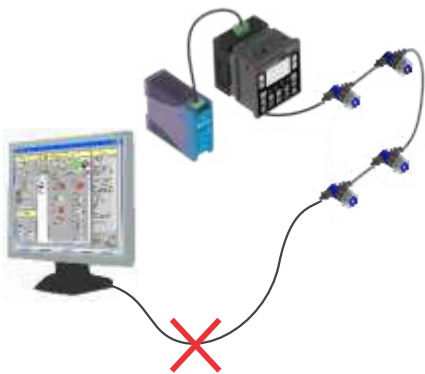

# SENSOR CONFIGURATION

## ADDRESSING SENSORS

To ensure that the system does not compromise its proper functioning, it is essential that all instructions for configuring the sensors, which will be explained below, are followed.

Each sensor must be configured before installing them mechanically.

**A)** Install the software on the computer and run it in sequence;

**B)** Connect the configuration cable (provided with the Zyggot Temperature Installation and Maintenance Case) to a USB port on the PC and to one of the sensor's mini USB ports.

**Note:** Unlike when the sensor is connected to the relay, the LED on the sensor body stops flashing when connected to the computer.

**C)** The program automatically detects the port corresponding to the sensor. If desired, it is also possible to manually select the sensor port. To do so, check the Manual Connection box, select the COM port corresponding to the sensor and press Connect. If there is no sensor connected to the selected port, an error message will appear.

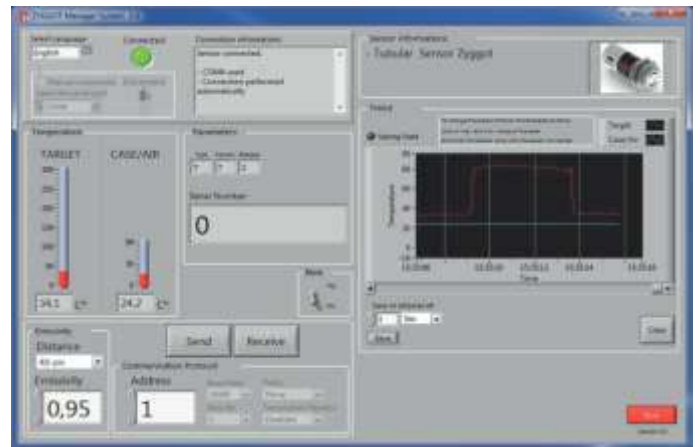

**D)** When connecting the sensor, the program will recognize it and indicate with a green button that it is connected.

**E)** Set the sensor address (1 to 100). By default, all sensors leave the factory with address 1 and correct network parameters for communication with the Zyggot Temperature relay. When finished, press the Send button.

**Note:** Each sensor must have a unique address on the network (from 1 to 100). When more than one sensor has the same address on the network, conflicts occur and the system will not operate.

**Note:** Wired sensor networks must have two termination resistors: one on the first sensor in the network and another on the last. The first of these is already integrated into the V5CON Interface. If other resistors are added to the network, the network may become unstable and may not function. Varixx provides physical termination resistors, encapsulated in a mini USB connector, for use in its sensor networks; simply insert them into the last sensor in the network.

**F)** Enter the target emissivity and press the Send button.

**Note:** When using Unidex tape (known and constant emissivity over the years), the emissivity value should be 0.95 (which is the standard emissivity value that sensors leave the factory with).

**G)** Enter the distance at which the sensor will be located from the target.

**Note:** The sensor is factory-set for a distance of 40 cm.

**H)** Write down the sensor address to have a map of its location on the panel or installation site. This is the address that will be shown on the relay screen for this sensor, for its correct identification.

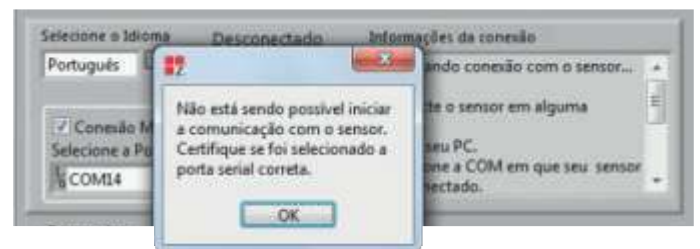

## FAIL SAFE SYSTEM

The Fail Safe System is a feature that allows the Zyggot relay to continue operating in the event of certain types of "soft" failures. These "soft" failures include:

- Loss of backup battery power.
- Corruption of the register RAM, or corruption of the firmware Flash due to, for example, an excessive EMI event.

Nome	Data de modificação	Tipo	Tamanho
■ PLOTZ21	17/08/2021 09:09	Pasta de arquivos	
■ DATANEW	18/08/2021 16:53	Pasta de arquivos	
■ DATAMAN	12/08/2021 16:27	Pasta de arquivos	
■ DATAAUTO	12/08/2021 10:38	Pasta de arquivos	
■ DEFAULT.PGM	09/08/2021 18:32	Arquivo PGM	482 KB
■ AUTOLOAD.PGM	09/08/2021 18:33	Arquivo PGM	482 KB
■ CLONE.DAT	09/08/2021 18:33	Arquivo DAT	107 KB
■ DATACARD	17/08/2021 19:06	Arquivo	1 KB
■ DATABCK	18/08/2021 09:51	Arquivo	1 KB
■ BACKZ	06/08/2021 17:47	Arquivo	1 KB

The Fail Safe System must have a file structure on the Memory Card similar to the one shown in the screen above.

Attention: With the exception of files within directories, which can be freely changed or deleted, files in the root directories cannot be modified or deleted, as this will interrupt the relay's operation.

The failsafe system encompasses the following features:

- Manually back up current registry settings from battery-backed RAM to Flash memory.
- Manually restore registry settings from previously saved values in Flash to battery-backed RAM.
- Detect corrupted registry settings at boot and then automatically restore them from Flash memory.
- Detect corrupted or empty Firmware in Flash memory at boot and then automatically load the **AUTOLOAD.PGM** file from removable media (Compact Flash / microSD).
- If an automatic registry restore or application load occurs, Zyggot V5FTA will automatically be put into RUN mode.

## HOW TO PROGRAM THE RELAY.

There are three ways: Using the HMI itself, or using the free PC configuration program, or using the Backup/Clone function from a memory card. To use the PC program, see the specific manual.

To program using the HMI:

Press «Menu», enter the correct password and follow the user-friendly submenus.

If the programming password is Zero, you will enter the menu directly; if it is different from zero, a screen will appear asking for the password. Enter it and press ENTER

Within the Param. Config. menu, you can change this password. The factory password is 1.

To program using the PC Software, see the specific manual for the software.

To Clone data using a memory card, use option 12. Backup/Clone in the Main menu.

Backup the data of a previously programmed relay using the «Backup» function

For a relay without programming, use the «Restore» function in this menu.

## ! HOW TO CONFIGURE THM SENSORS ("THM SENSOR" MENU)

! Enter the **Programming Menu** and then the **THM Sensors** submenu.

- ! Choose the item to change and press **ENTER**,
- ! Choose the option from the list of each parameter or enter the data if it is numeric,
- ! Press **ENTER** to confirm,
- ! Choose the next item and repeat the operation.

## HOW TO CHANGE THE PROGRAMMING PASSWORD ("RELAY CONFIG" MENU).

! Enter the **Main Menu** and then the **Relay Config** submenu.

- ! Choose the item to change and press **ENTER**.
- ! **Menu Pass:** Enter the new password if you wish to change it. The factory password is **827499**. If you enter "0" as the new password, you can enter the Menu without a password by simply pressing the Menu key.
- ! Press **ENTER** to confirm.

## HOW TO NAME THE PLANT, LOCATION AND PANEL AND ENTER THE START DATE OF OPERATION.

For information purposes, the above items can be named with up to 5 characters. Proceed as follows:

Enter Menu, **Relay Config Submenu**, Select the desired item, Press **Enter**, Enter the new data using the numeric keys, press **Enter** to confirm and **ESC** to exit the menu.

## HOW TO CHECK MULTI GATEWAY STATUS.

To view the gateway map with ARC STATUS fault detection, press the "Multi Gateway Status" button to bring up screen GF01 and use the arrows to view all screens if necessary. The indicators may be in 2 different colors: Green if OK or Red if a fault is detected.

## HOW TO CONFIGURE MODBUS COMMUNICATION. ("MODBUS" MENU).

The names for this menu are the classic ones and there is nothing to explain, since the user must know the protocol to use Modbus communication. The port for Modbus communication is Rj1.

Enter the **Programming Menu** and then the **Modbus CFG** submenu.

Choose the item to change and press **ENTER** Choose the option from the list for each parameter or enter the data if it is numeric.

Press **ENTER** to confirm.

Choose the next item and repeat the operation.

**The parameters are as follows:**  
Baud Rate, Address, Parity, Handshake, Timeout, Port Mode (RS232 or RS 245), Stop Bits and Modbus (Active, Inactive)

## HOW TO SET PARAMETERS ("PARAMETERS" MENU).

! Enter the **Main Menu** and then the **Config Parameters** submenu.

- ! Choose the item to change and press **ENTER**,
- ! Choose the option in the list for each parameter or enter the data if it is numeric,
- ! Press **ENTER** to confirm,
- ! Choose the next item and repeat the operation.

## HOW TO PROGRAM ARV FLASH PARAMETERS.

! In the **Main Menu**, choose the **ARC PARAMETER** option. The sub-Menu with 11 items is displayed.

! Choose each item to be changed and enter the new values.

! To program the system gateways, choose the **"Gateway Programm"** option and select "Enable".

! Then choose the **"Prog. GTWY Param."** option.

! Choose the **"GO"** option on the alert screen.

! The "Programming Gateways" screen is displayed.

! Press the **"Manual"** key.

! Press the **"GATEWAY"** key and the numeric keypad will appear.

! Enter **"0"** to program all Gateways with the same parameters or enter the number of the gateway to be programmed (previously program the parameters in the items above the menu).

! Press the **"Proceed"** button and choose the **"YES"** option.

! The screen will show the progress of the program and the Proceed key will return to **"NO"**.

## HOW TO PROGRAM GATEWAY ADDRESSES (MULTI VERSION ONLY).

Gateways come from the factory with the address **200**, which is the address to be used for the first gateway in the system, with subsequent gateways being 201, 202, etc. In the case of the Mono Gateway system, address 200 should be used.

The Superger software or the relay itself can be used to program the addresses.

Ensure that only one gateway is connected to the network and that it has the address 200 (if you are unsure of the address set on it, simply reset it using a paperclip in the small hole on the front of the gateway).

If using relays, in the **Main Menu** choose the **ARC PARAMETER** option. The sub-Menu with 11 items is displayed.

Choose the **"Gateway Programm"** option and select "Enable".

Choose the **"Gateway Number"** option and enter "1".

Then choose the **"Prog. GTWY Address"** option.

Choose the **"GO"** option on the alert screen.

The "Address Programming" screen is displayed.

Enter **"201"** to **"239"** as appropriate for the new address to be set on the gateway.

Press the "Proceed" button and choose the **"YES"** option.

When it returns to **"NO"**, remove the Connect the network gateway and repeat the procedure with others if necessary.

## HOW TO MUTE AND RESET USING MODBUS.

To execute the **"Mute"** command via **Modbus**, simply write 1 in the flag **"%M1303"**.

To execute the **"Reset"** command via **Modbus**, simply write 1 in the flag **"%M1304"**.

In both cases, the command is interpreted as a Pulse, and the flags are automatically returned to zero.

## HOW TO CHANGE SCAN MODE FROM "AUTO" TO "MANUAL" AND FROM "MANUAL" TO "AUTO" USING MODBUS.

To change the scan mode from **"Auto"** to **"Manual"** via **Modbus**, simply write 1 in the flag **"%M1301"**.

To change the scan mode from **"Manual"** to **"Auto"** via **Modbus**, simply write 1 in the flag **"%M1302"**.

In both cases, the command is interpreted as a Pulse and the flags are automatically returned to zero.

Attention: The relay always starts in **"Auto"** scan mode when switched on. The **"Return to Auto"** parameter in the arc menu allows you to choose a time for automatic return to **"Auto"** mode, as remaining in **"Manual"** mode requires caution because in **"Manual"** mode the relay only monitors the currently selected Gateway. Trip protections on the Gateways themselves remain active even in **"Manual"** mode, not compromising system safety in the event of an arc fault, but the protections and indications generated by the relay in this case do not occur in relation to unmonitored Gateways.

From Version V05.71 onwards, it is possible to select zero (0) for this time, and in this case, returning to **"Auto"** scan mode is inhibited, always remaining in **"Manual"** once the change to **"Manual"** mode is made. This configuration can be useful for use with the user's DCS, only controlling the change of monitored Gateway without having to constantly change the scan mode, but it should be used with caution.

In **"Manual"** mode, the arc occurrence flags for sensors 1 to 100 of the selected gateway can be read in flags **%M801** to **%M900**, and the Trip occurrence flag for each gateway from 1 to 40 can be monitored by flag **%M194** relative to the selected gateway. (If in **"Auto"** mode, these flags do not remain stable due to edematous scanning of the gateways.)

In **"Automatic"** mode, the arc occurrence flags for sensors 1 to 96 of each gateway can be stably monitored by flags **%M2001** to **%M5840** (flags **%M** are multiples of 16, and for this reason it is not possible to monitor all 100 sensors of each gateway, nor to have starting points in whole decimal numbering). In **"Automatic"** mode, the Trip occurrence flags for each Gateway can be reliably monitored using flags **%M1601** to **%M1640**.

See the complete address table on page 112.

## HOW TO CHECK IF THM SENSORS ARE NOT RESPONDING OR ARC SENSORS ARE NOT RESPONDING.

To view the map of non-responding THM or ARCO sensors, press **12.THM STATUS** or **18.ARC STATUS** respectively. Then press **THM NOT RESPONDING** or **ARC SENSORS NOT RESPONDING** respectively to bring up the display screens and use the arrows to view all screens if necessary. In the Multi Gateways version, if the Scan mode is set to manual, two buttons (**UP** and **DOWN**) appear to navigate the system gateways. Non-responding sensors will be shown with red squares.

# HOW TO DO...

## HOW TO CONFIGURE THE CURVES (TRENDING). (MENU "CONFIG TRENDING").

Curves referring to temperatures and analog inputs must be configured in this menu.

Enter the Main Menu and then the Config Trending submenu.

Choose the item to change and press **ENTER**.

Choose the option in the list for each parameter or enter the data if it is numeric or alphanumeric.

Press **ENTER** to confirm.

Choose the next item and repeat the operation.

The parameters are as follows:

**Scale:** Enter the scale to use for all curves.

**Index Mode:** (Display, Menu). If Display is chosen, the operator must enter the indices of each curve directly on the curve screens as explained in the Operation chapter. If Menu is chosen, the indexes used will be those inserted below.

**HMI Reset:** (No, Yes). Enables or not the possibility of the operator being able to reset or restart each curve using the ESC command (to do this, hold down the ESC key for 3 seconds and the curve will restart).

Index 1A-5A to Index 6C-10C.

**(1 to 104):** enter the sensor numbers from 1 to 100. These are the signals that will be used in the corresponding curves if Menu mode is chosen in Index Mode. Curves from indexes 1 to 5 (A, B and C, i.e. three curves each trending screen) will be shown on trending screens 3 to 7 and curves from indexes 6 to 10 will be shown on screens 8 to 12. **Note:** Indices 101 through 104 are used to address analog inputs 1 through 4.

For the T18 screen, which is retentive and can save time curves in Excel format on the memory card, select the **Enable Retentive** item and choose «**Yes**».

See more details in the Programming chapter.

## HOW TO PROGRAM MULTIPLE RELAYS WITH THE SAME PARAMETERS MORE EASILY.

- ! First, program and test a relay with the desired parameters.
- ! In the main menu, choose the "**Backup/Restore Data**" sub-menu.
- ! In the "**Backup/Restore Data**" sub-menu, choose the "**Clone Parameters**" option.
- ! On the next screen, press the "**Backup?**" button and select "**Yes**". This action saves the parameters to the memory card inserted in the top of the relay.
- ! Exit the programming menu and in the main menu choose the "**ESC**" option.
- ! On the displayed information screens, use the pagination buttons until the "Remove / Insert Card Safely" screen is shown.
- ! Press the "**Remove / Insert**" button and choose the "**Yes**" option. The "**Ready to Remove / Insert**" signal will be activated.
- ! Remove the card from the relay.
- ! Insert this card into the new relay to be programmed, after repeating the actions above, from the "**Remove / Insert Card Safely**" screen.
- ! Return to the programming menu and repeat the steps above until you reach the "**Backup/Restore Data**" screen.
- ! Press the "**Restore**" button and select "**Yes**". At this moment, the parameters recorded on the card will be copied to the new relay.
- ! Repeat the recording operation above for each new relay.
- ! Return the original card to the first relay used for initial programming.
- ! **NOTE:** The relay only operates with its personalized card inserted, so for each relay to be programmed, initially turn it on, wait 30 seconds after the screens stabilize (with the proper reading of the relay's personalized card) before removing it after the "**Remove / Insert**" screen and inserting the card with the data to be copied into the new relay. After copying the parameters, return the original card to the new relay.

## HOW TO DEFINE EMISSIVITIES FOR EACH TARGET. (MENU "SENSOR").

The emissivity indices for each target can be defined in the programming of the sensor itself, where the emissivity and the sensor address are entered, using the free PC program available on our website. See specific manual for the sensor programming software.

## HOW TO SET ALARM LEVELS FOR TARGET OVERTEMPERATURE. (MENU "TARGET ALRM LEVELS").

Target alarm levels can be defined in block programming, as explained above. A single group with all sensors can be programmed if the level is the same for all or up to 5 different levels, one for each block. Another way, even after programming by blocks and if you want to individually change some or all of the levels, is through the "Alarm Target Levels" menu.

Enter the Main Menu and then the Alrm Target Levels submenu.

A menu with 13 submenus is displayed, each containing up to 10 levels.

Select the level to change and enter the value.

Press **ENTER** to confirm.

Choose the next item and repeat the operation.

## HOW TO CONFIGURE ANALOG INPUTS. (MENU "ANALOG INPUT").

For the analog inputs, you can enter the name of each one (5 characters), facilitating the identification, choosing the reading mode and the scale.

Enter the **Main Menu** and then the Input submenu **Analog Inputs**.

Choose the item to change and press **ENTER**.

Choose the option from the list of each parameter or enter the data if it is numerical or alphanumeric.

Press **ENTER** to confirm.

Choose the next item and repeat the operation.

## HOW TO CHECK SENSORS NOT RESPONDING.

To view the map of non-responsive sensors, press **THM STATUS** or **ARC STATUS**, and after press **Not Responding**, to call up the NR1 screen and use the arrows to view all NR screens if necessary. Non-responsive sensors will be marked with purple squares.

If there is no response during a reading attempt, the indication on the main screen will be activated and all indicators of non-responsive sensors on screens NR1 to NR9 will be activated, since there was no response. In this case, all temperature readings will be indicated with 8888, as invalid. In this case, there will be no trip or alarm due to temperature, but only due to Not Responding if it is enabled.

## HOW TO CHOOSE THE LANGUAGE.

For the screens and menus, the relay is available in 3 languages: English, Portuguese and Spanish. Any fourth language can be requested at the time of purchase (Custom) by prior agreement with the manufacturer.

To select the language:

Enter the Menu, Relay Configuration Submenu,

Select the Language item,

Press Enter,

Select the required language by pressing Enter again to confirm and ESC to exit the menu.

## HOW TO SET ALARM LEVELS FOR TARGET OVERTEMPERATURE. (MENU "TRIP TARGETED LEVELS").

Target tripping levels can be defined in block programming, as explained above. A single group with all sensors can be programmed if the level is the same for all or up to 5 different levels, one for each block. Another way, even after programming by blocks and if you want to individually change some or all of the levels, is via the "Target Trip Levels" menu.

Enter the Main Menu and then the Trip Target Levels submenu.

A menu with 13 submenus is displayed, each containing up to 10 levels.

Select the level to change and enter the value.

Press **ENTER** to confirm.

Choose the next item and repeat the operation.

## HOW TO DEFINE THE ACTIONS AND AUXILIARY RELAYS ACTIVATED FOR EACH PROTECTION. (MENU "PROTECTIONS").

The action to be taken, which can be: Nothing (disables the protection), Log (the event is entered in the history and alarms list but no output relay is activated (not even the Alarm relay or the Trip relay), Alarm (the Alarm output relay is activated) and Trip (the "Alarm" and "Trip" outputs are activated).

There are 2 protection submenus: Protections 1/2 and Protections 2/2.

The first contains the general protections, the second the protections referring to analog inputs and external faults.

Enter the Main Menu and then the Protections submenu.

A menu with 3 submenus is displayed.

Select one of them and press **ENTER**.

Select the protection sub-item to be programmed and press **ENTER**.

Select the action and auxiliary relay.

## HOW TO CHECK SENSORS' POWER SUPPLY VOLTAGES.

To view the map of unresponsive sensors, press **THM STATUS** or **ARC STATUS**, then press the "**THM Sensors Voltage Levels**" or "**Arc Sensors Voltage Levels**" button to bring up the TV01 or AV01 screen respectively, and use the arrows to view all screens if necessary. The sensors may be in 3 different colors depending on the voltage range, or purple if they are not responding.

In the Multi Gateway version, use the "**Up**" and "**Down**" keys to page through the gateways after switching to manual scanning on the previous screen by pressing the "**SCAN**" key.

## HOW TO SET THE REAL-TIME CLOCK.

If necessary, due to daylight saving time or other reasons, proceed as follows:

Go to **Menu, Relay Config** submenu,

Select the Set Real Time Clock item,

Press **Enter**, Enter the new data using the small arrows under the display, press Enter to confirm and **ESC** to exit the menu.

# SUPERVISORY SOFTWARE

## ZYGGOT THERMOGRAPHY 2.1 SUPERVISORY SOFTWARE

Zyggot Supervisory - **Version 3.10** and higher, is a program that communicates with the relay and presents sensor readings on the computer screen just like a supervisory system. The software is available free of charge through the Varixx website (<http://www.varixx.com.br>). Install the Software on your Windows computer. All files needed to run, including "Runtime" files, are already included in the package, meaning no additional software is required. Once installed it will be ready to run.

2- The first step is to press the **Configure Modbus** button. You can see the initial screen "**Configure Modbus**". Once you have chosen the connection mode, namely a) **Modbus RTU** (Serial) or b) **Modbus TCP** (Ethernet) (in the top selection box, under the phrase «Select the communication medium) and entered the parameters corresponding to those entered in the relay you can click on the «Connect» button and if the connection occurs, the «Connected» flag will turn from red to green.

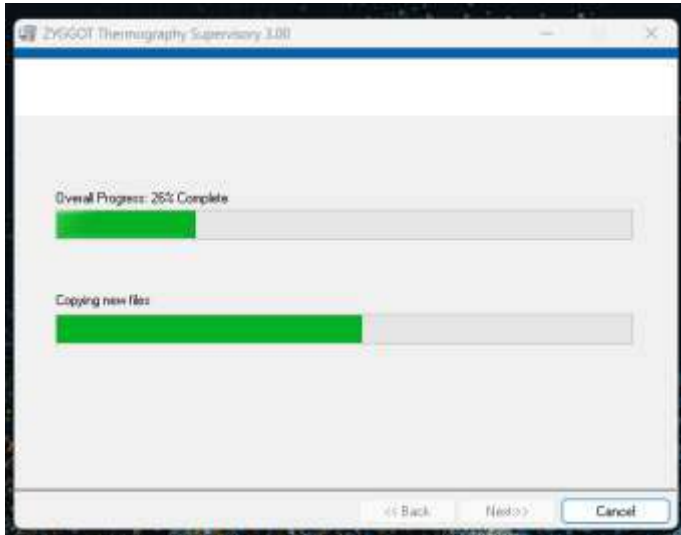

1- The first step is to connect to the relay. To do so, adjust the Modbus communication values on the relay and activate it in RS-232 mode. For details on how to activate Modbus see the programming menu section. Use an RS-232 / RJ45 cable to connect the relay and a computer. You can also use the Ethernet port and do all programming via Ethernet communication. In this case, program the correct address as programmed in the relay in the Ethernet programming part (Modbus TCP/IP). Use an Ethernet cable in this mode.

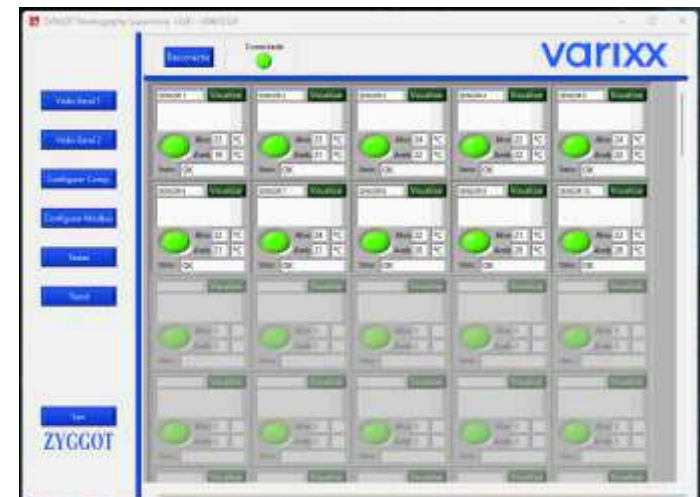

**Note:** This software is not required for system operation. It is a bonus that the user can use to check the system or not.



# SUPERVISORY SOFTWARE

## ZYGGOT THERMOGRAPHY 2.1 SUPERVISORY SOFTWARE

3- Once connected, click on the «**Overview 1**» button, you can observe the target and air temperatures (sensor body) of each sensor responding on the network and a description of the same case inserted.

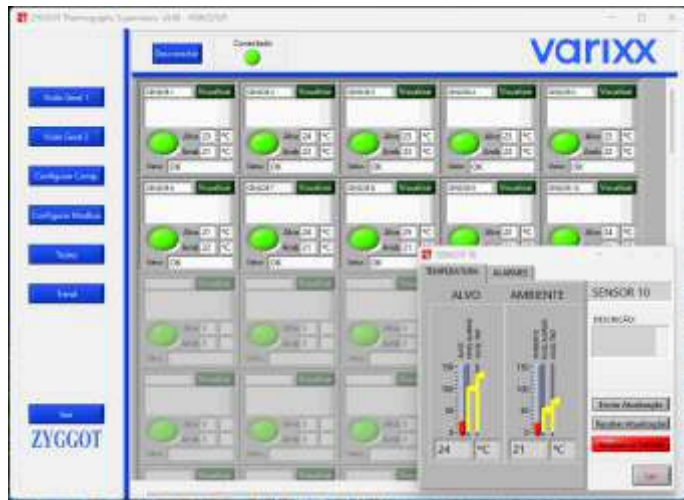

4- Click on the «**View**» button or on the lens symbol for each of the sensors. A window opens with alarm adjustment sliders and Alarm and Trip level parameters, which can be adjusted using the mouse and sent to the relay by clicking the “Send update” button. Note that when changing the slide its color changes from blue to yellow until «**Update**» is commanded. This function is also used to test the operation of the Alarm or Trip by adjusting levels below the current reading levels indicated in red. By clicking on the «**Alarms**» tab in this window for each sensor, you can also change the Alarm and Trip levels through the corresponding windows, using the mouse or by entering the values using the keyboard. Note that the color of the window changes to red until the “Send update” command is made. This way you can change relay parameters in real time.

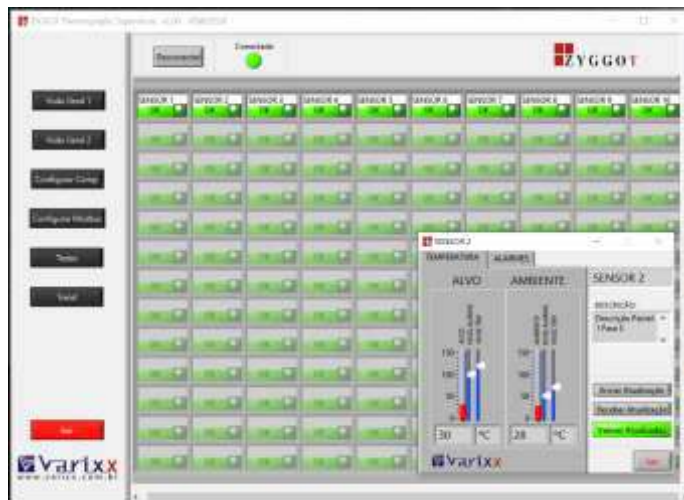

5- Click on the «**Configure Comp**» button in the menu on the left and the following screen opens with 3 options, namely «**Sensors**», «**Thermometers**» and «**Alarm Levels**»

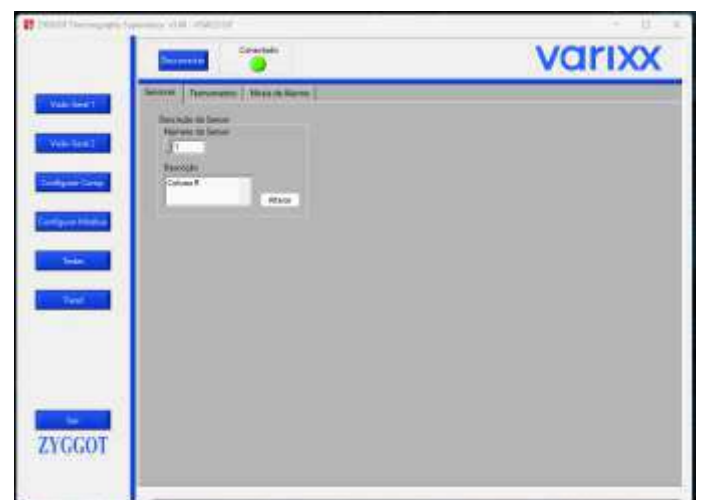

6- Click on the «**Sensors**» tab and you can enter a description of each of the sensors, for example «**Column R**» etc. Click on the Thermometers tab and you can change the scales of each thermometer on the graph. Click on the “**Alarm Levels**” tab and you can change the waiting time to be notified of a change in level.

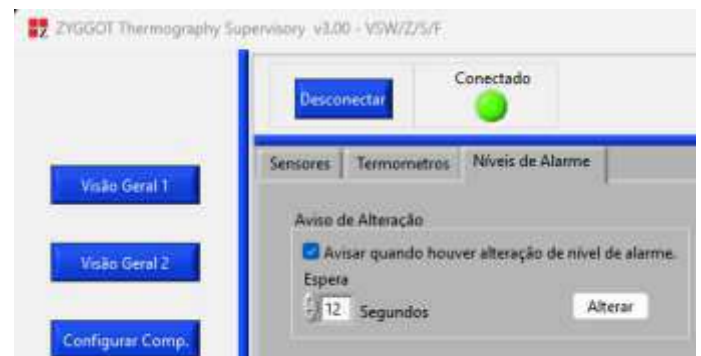

6- Click on the «**Test**» tab and you can change the LED blinking mode on each sensor, from blinking to continuous or vice versa to locate it on the panel or to test whether it is responding correctly on the network. Zero commands the change in all sensors.



# SOFTWARE SUPERVISÓRIO

## SOFTWARE SUPERVISÓRIO ZYGGOT THERMOGRAPHY 2.0

7- Click on the «Trend» button and you can see the screen on which you can plot the Target and Air temperatures of up to 10 sensors simultaneously.

Through the corresponding windows you can choose the sensors to be plotted, whether **Target** and/or **Air** and the trace color of each one. To change the color, click on the small colored square for each stroke and choose the new color.

In the lower window on the left side you can choose the period for automatic saving of readings in a CSV file which can be opened in Excel.

You can also command manual saving at any time using the “Save” key. Using the “Save” button, you can save the data read so far in Excel CSV format for later documentation, and you can even generate the corresponding graphs. Once clicked on save a window to choose the destination and file name will appear.

In the last figure, below, you can see an example file, with 5 sensors and Target and Air temperatures for each of the readings.

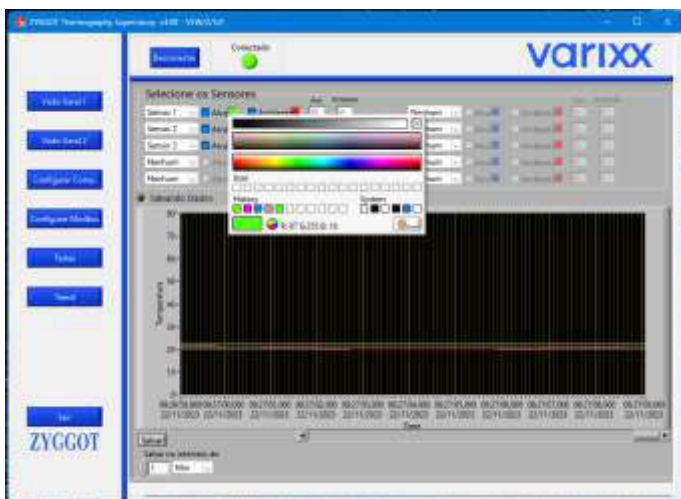
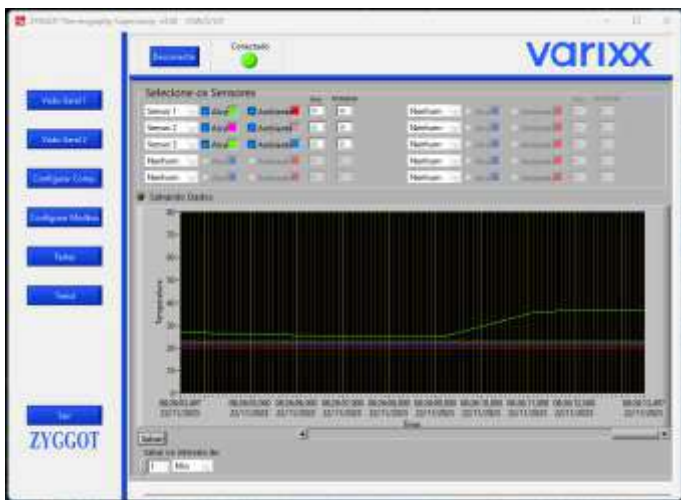
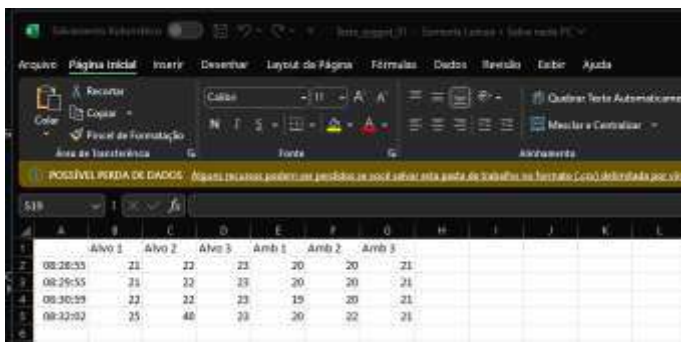
The screenshot shows an Excel spreadsheet with the following data:

	Año 1	Año 2	Año 3	Amb 1	Amb 2	Amb 3
1						
2	08:28:55	21	22	23	20	20
3	08:29:55	21	22	23	20	20
4	08:30:59	22	22	23	19	20
5	08:32:02	25	48	33	30	21

# ASCII OVER TCP/IP DATA TABLE

## ASCII OVER TCP/IP PROTOCOL



**DATA Received 500 bytes (8 Bits) (250 Words 16 bits)**  
**ASCII: 8Bits**

This data can be used to set the Alarm and Trip levels independently for each of the 100 sensors.

To copy the received data to the corresponding parameters after successful reception, the **%M99** Flag or the Byte T (Bytes 3 and 4) must be set, depending on what is selected in the «Copy Trigger» parameter on the **ETH8** screen (Byte T (Byte Termination) and Flag **%M99** options).

To start the transmission, the **%M100** flag must be set on the corresponding screen either through the normal TCP/IP protocol or through serial communication with Modbus.

After copying the Records, if Copy Enabled, these Bytes (Byte 3 and Byte 4) return to zero automatically (See details in the respective chapter in this manual).

Note that to set the **%M100** flag it will be necessary to do so through the TCP/IP (Modbus Over Ethernet) protocol. The only advantage of using the ASCII OVER TCP/IP protocol, as described here, is to transmit all the data at once, but for security reasons, it should be avoided. In addition, the user will have to convert two bytes into 1 word to obtain the values.

Note that to set the **%M99** Flag it will be necessary to do so via the TCP/IP protocol (Modbus Over Ethernet) or via serial communication with Modbus.

Note that through the TCP/IP (Modbus Over Ethernet) protocol the same data can be read normally.

In the **ASCII OVER TCP/IP** protocol, as described here, all data is transmitted at once. For safety reasons, this method should be avoided. Furthermore, the user will have to convert two Bytes into 1 Word to obtain the values.

**NOTE:** This protocol is described here because it can optionally be used but it is always preferable to use Modbus in a serial connection directly or Modbus Over Ethernet TCP IP discussed below and much more practical and direct.

Prefer to use Modbus Over Ethernet directly, according to the Modbus tables in this Manual or programming directly on the Zyggot Relay screen or programming by transferring data from the Memory Card when programming more than one relay with the same parameters.

**DATA TRANSMITTED 500 bytes (8 Bits) (250 Words 16 bits)**  
**ASCII: 8Bits**

**Note:** as 500 Bytes (8 Bits) are transmitted, which is equivalent to 250 Words (16 Bits), the user must convert 2 Bytes into a word to obtain the transmitted data. Byte 1 = Set to 500 (indicates the number of Bytes to be transmitted). Byte 2 = Byte T = 0 or 1 - Set to 1 if the Byte T (Byte Termination) option is selected in the «Copy Trigger» parameter and not Flag **%M99**.

Note that the same data can be written normally using the TCP/IP Protocol (Modbus Over Ethernet).

**Note:** since 506 Bytes (8 Bits) will be received, which is equivalent to 253 Words (16 Bits), the user must convert a word (16 Bits) into 2 Bytes (8 Bits) before transmitting the data.

After copying the Records, if it is allowed (Copy Enabled), this Byte returns to zero automatically (See details in the respective chapter in this manual).

**Byte 3** = LSB Temp. Target of Sensor 1

**Byte 4** = MSB Temp. Target of Sensor 1

**Byte 5** = LSB Temp. Target of Sensor 2

**Byte 6** = MSB Temp. Target of Sensor 2

===

**Byte 202** = LSB Temp. Target of Sensor 100

**Byte 203** = MSB Temp. Target of Sensor 100

**Byte 204** = LSB Temp. Air Sensor 1

**Byte 205** = MSB Temp. Air Sensor 1

===

**Byte 402** = LSB Temp. Air Sensor 100

**Byte 403** = MSB Temp. Air Sensor 100

**Bytes 404 to 500** = N.U.

**Byte 1** = LSB Alarm Level Sensor 1,

**Byte 2** = MSB Alarm Level Sensor 1

**Byte 3** = LSB Alarm Level Sensor 2

**Byte 4** = MSB Alarm Level Sensor 2

===

**Byte 199** = LSB Trip Level Sensor 100

**Byte 200** = MSB Trip Level Sensor 100

**Byte 201** = LSB Air Alarm Level Sensor 1

**Byte 202** = MSB Air Alarm Level Sensor 1

===

**Byte 399** = LSB Air Trip Level Sensor 100

**Byte 400** = MSB Air Trip Level Sensor 100

**Bytes 401 to 506** = N.U.

# MODBUS

A complete explanation of the Modbus RTU or ASCII protocol is not within the scope of this manual. It is assumed that the user who will apply the same using this protocol, must have sufficient knowledge for this.

Also, in this manual we will only provide the basic addresses of the memory map to perform the usual operations of reading faults and others. Any parameter programming must be performed on the device itself, as it is normally done only once, during Startup.

Next, there will be a short introduction to the Modbus communication network before the memory map presentation.

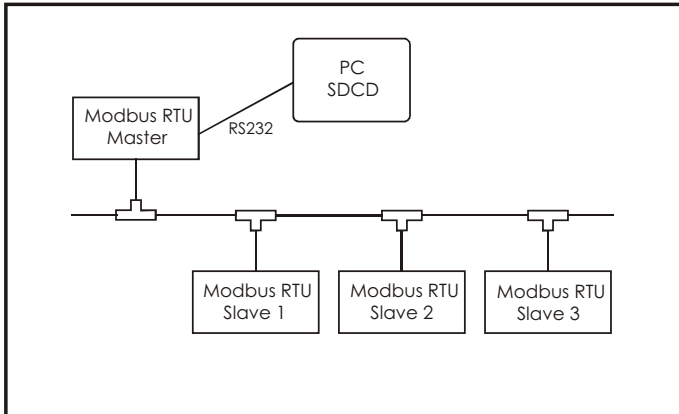

Devices communicate using a master-slave technique, in which only one device (the master) can initiate transactions (called 'queries'). The other devices (the slaves) respond by supplying the requested data to the master, or by taking the action requested in the query. Typical master devices include host processors and programming panels. Typical slaves include programmable controllers, motor controllers, load monitors etc, see Fig

The master can address individual slaves. Slaves return a message (called a 'response') to queries that are addressed to them individually. The Modbus protocol establishes the format for the master's query by placing into it the device address, a function code defining the requested action, any data to be sent, and an error checking field. The slave's response message is also constructed using Modbus protocol. It contains fields confirming the action taken, any data to be returned and an error-checking field. If an error occurred in receiving the message, or if the slave is unable to perform the requested action, the slave will construct an error message and send this as its response, see Fig.

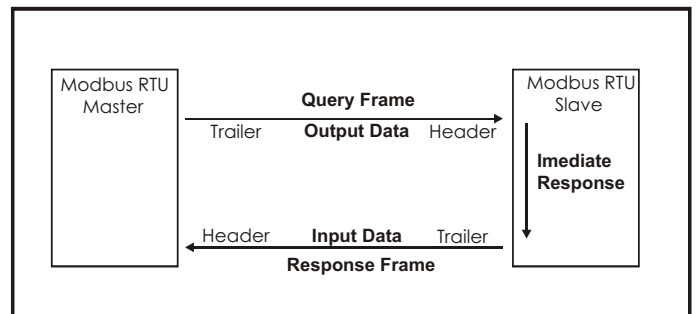

## Address field

The address field of a message frame contains eight bits. The individual slave devices are assigned addresses in the range of 1 - 247. A master addresses a slave by placing the slave address in the address field of the message.

When the slave sends its response, it places its own address in this address field of the response to let the master know which slave is responding.

## Function field

The function code field of a message frame contains eight bits. Valid codes are in the range of 1 - 6, 15, 16 and 23. When a message is sent from a master to a slave device, the function code field tells the slave what kind of action to perform.

Examples are:

- to read the ON/OFF states of a group of inputs;
- to read the data contents of a group of parameters;
- to read the diagnostic status of the slave;
- to write to designated coils or registers within the slave.

When the slave responds to the master, it uses the function code field to indicate either a normal (error-free) response or that some kind of error occurred (called an exception response). For a normal response, the slave simply echoes the original function code. For an exception response, the slave returns a code that is equivalent to the original function code with its most significant bit set to a logic 1.

In addition to its modification of the function code for an exception response, the slave places an unique code into the data field of the response message. This tells the master what kind of error occurred, or the reason for the exception.

The master device's application program has the responsibility of handling exception responses. Typical processes are to post subsequent retries of the message, to try diagnostic messages to the slave and to notify operators. Additional information about function codes and exceptions comes later.

## Data field

The data field is constructed using sets of two hexadecimal digits (8 bits), in the range of 00 to FF hexadecimal.

The data field of messages sent from a master to slave devices contains additional information which the slave must use to take the action defined by the function code. This can include items like discrete and register addresses, the quantity of items to be handled and the count of actual data bytes in the field.

For example, if the master requests a slave to read a group of holding registers (function code 03), the data field specifies the starting register and how many registers are to be read. If the master writes to a group of registers in the slave (function code 10 hexadecimal), the data field specifies the starting register, how many registers to write, the count of data bytes to follow in the data field, and the data to be written into the registers.

If no error occurs, the data field of a response from a slave to a master contains the data requested. If an error occurs, the field contains an exception code that the master application can use to determine the next action to be taken.

## CRC Error checking field

The error checking field contains a 16 bit value implemented as 2 bytes. The error check value is the result of a Cyclical Redundancy Check (CRC) calculation performed on the message contents.

The CRC field is appended to the message as the last field in the message. When this is done, the low-order byte of the field is appended first, followed by the high-order byte. The CRC high-order byte is the last byte to be sent in the message. Additional information about CRC calculation are found in this manual.

## Functions

### Standard MODBUS function codes.

Function name	Function code
Read Coil (Bit) Status	1 (01h)
Read Input Status	2 (02h)
Read Holding Registers	3 (03h)
Read Input Registers	4 (04h)
Force Single Coil (Bit)	5 (05h)
Force Single Register	6 (06h)
Force Multiple Coils (Bits)	15 (0Fh)
Force Multiple Registers	16 (10h)
Force/Read Multiple Holding Registers	23 (17h)

## Reading Input Status

Reading the status of digital information - read only.

EXAMPLE: Request digital input 2. Assuming it is not active.

Status: Modbus no = 2.

### Request message.

Field name	Hex value
Slave address	01
Function	02
Start address HI	00
Start address LO	02
Number of Inputs HI	00
Number of Inputs LO	01
CRC LO	18
CRC HI	0A

Response message.

Field name	Hex value
Slave address	01
Function	02
Byte count	01
Input no.2 (02h)status	00
CRC LO	A1
CRC HI	88

## Reading Holding Registers

Read the value of the analog variable information.

### Example,

Asking for some Voltage, Frequency and Current. Their values are 400.0V, 60Hz and 15.5A.

400.0V, 0.1V unit - 4000 (0FA0h)

60Hz 1Hz unit - 60 (003Ch)

15.5A, 0.1A unit - 155 (009Bh)

Request message.

Field name	Hex value
Slave address	01
Function	0
Start address HI	00
Start address LO	00
Number of Registers HI	00
Number of Registers LO	03
CRC LO	05
CRC HI	CB

Response message

Field name	Hex value
Slave address	01
Function	03
Byte count	06
Reg no. 0, (0h) data HI	0F
Reg no. 0, (0h) data LO	A0
Reg no. 1, (1h) data HI	00
Reg no. 1, (1h) data LO	3C
Reg no. 2, (2h) data HI	00
Reg no. 2, (2h) data LO	9B
CRC LO	20
CRC HI	34

## Reading Coil Status

Read the status of mutable digital parameters.

### Example

Requesting the state of coil input (Bit) 29. Assume it is on

30 input: Modbus no = 29 (1Dh)

On = Yes = 1 Coil = 0001

1 byte of data: Byte count=01

Request message.

Field name	Hex value
Slave address	01
Function	01
Start address HI	00
Start address LO	1D
Number of Coils HI	00
Number of Coils LO	01
CRC LO	6D
CRC HI	CC

Response message.

Field name	Hex value
Slave address	01
Function	01
Byte count	01
Coil no.29 (1Dh) status	01
CRC LO	90
CRC HI	48

## Reading Input Registers

Read the contents of the read-only analog information.

### Example

Request the Modbus value 30011 - No. 10. Assume it is 452.0. It is long representation. 2 registers are used (30011 high word and 30012 low word)  
452.0, unit 0.1 - 4520 (000011A8h).

### Request message.

Field name	Hex value
Slave address	01
Function	04
Start address HI	00
Start address LO	0A
Number of Registers HI	00
Number of Registers LO	02
CRC LO	51
CRC HI	C9

### Response message.

Field name	Hex value
Slave address	01
Function	04
Byte count	04
Reg no. 10 (0Ah) data HI	00
Reg no. 10 (0Ah) data LO	00
Reg no. 11 (0Bh) data HI	11
Reg no. 11 (0Bh) data LO	A8
CRC LO	F6
CRC HI	6A

## Forcing Single Coil (Bit)

Set the status of a changeable digital parameter.

### Example

Set a command to ON. This will cause some type of action.  
Modbus no = 1 - LO address 1 (01h)  
Execute = 1 - 0 Data HI = 255 (0FFh), Data LO = 00 (00h)

### Request message..

Field name	Hex value
Slave address	01
Function	05
Start address HI	00
Start address LO	01
Data HI	FF
Data LO	00
CRC LO	DD
CRC HI	FA

### Response message.

Field name	Hex value
Slave address	01
Function	05
Start address HI	00
Start address LO	01
Data HI	FF
Data LO	00
CRC LO	DD
CRC HI	FA

## Force Multiple Coil

Set the status of several changeable digital parameters.

### Example

Set one flag to ON and another to ON. This will cause some actions or change parameters. Coil n. = 0-1 Reset -> 1 // Run = 1 -> 00000011 (03h)

#### Request message.

Field name	Hex value
Slave address	01
Function	0F
Start address HI	00
Start address LO	00
Number of Coils HI	00
Number of Coils LO	02
Byte count	01
Coil no. 0-1 status (0000 0011B)	03
CRC LO	9E
CRC HI	96

#### Response message.

Field name	Hex value
Slave address	01
Function	0F
Start address HI	00
Start address LO	00
Number of Coils HI	00
Number of Coils LO	02
CRC LO	D4
CRC HI	0A

## Forcing Multiple Registers

Set the contents of several changeable analog parameters.

### Example

Set register 40018 (Modbus No. 17) to 25.0 (250 / 10) and 40019 (Modbus No. 18) to 55. 25.0, unit 0.1 -> -250 (00FAh) // 55, unit 1% -> 55 (0037h)

#### Request message.

Field name	Hex value
Slave address	01
Function	10
Start address HI	00
Start address LO	11
Number of Registers HI	00
Number of Registers LO	02
Byte count	04
Data HI reg 17 (11h)	00
Data LO reg 17 (11h)	FA
Data HI reg 18 (12h)	00
Data LO reg 18 (12h)	37
CRC LO	52
CRC HI	88

#### Response message.

Field name	Hex value
Slave address	01
Function	10
Start address HI	00
Start address LO	11
Number of Registers HI	00
Number of Registers LO	02
CRC LO	11
CRC HI	CD

## Force/Read Multiple Register

Set and read the contents of multiple modifiable analog parameters in the same message.

### Example

Set one parameter to 2 (40022 = Modbus No. 21) and another to 1 (40023 = Modbus No. 22) and read the other two. They are 1450 and 17000.

1450, unit 1 -> 1450 (05AAh)  
17000, unit 1 -> 17000 (4268h)

#### Request message.

Field name	Hex value
Slave address	01
Function	17
Start read address HI	00
Start read address LO	03
Number of read Regs HI	00
Number of read Regs LO	02
Start write address HI	00
Start write address LO	15
Number of write Regs HI	00
Number of write Regs LO	02
Byte count	04
Data HI Reg 21 (15h)	00
Data LO Reg 21 (15h)	02
Data HI Reg 22 (16h)	00
Data LO Reg 22 (16h)	01
CRC LO	62
CRC HI	77

#### Response message.

Field name	Hex value
Slave address	01
Function	17
Byte count	04
Reg no. 3, (3h) data HI	05
Reg no. 3, (3h) data LO	AA
Reg no. 4, (4h) data HI	42
Reg no. 4, (4h) data LO	68
CRC LO	E8
CRC HI	85

## Exception response message..

Field name	Hex value
Slave address	01
Function	84
Exception code	02
CRC LO	C2
CRC HI	C1

### Exception codes.

Exc. code	Name	Description
01	Illegal function	This unit doesn't support the function code.
02	Illegal data address	The data address is not within its boundaries.
03	Illegal data value	The data value is not within its boundaries.
06	Busy	The unit is unable to perform the request at this time. Retry later.

### In case of using an RS232 / RS485 Converter:

An RS485 is suitable for a multi-droop network.

In a multi-droop Modbus network, termination with resistors is required on the last slave unit of the two- or four-wire network cable.

These resistors increase noise immunity and their failure to install them compromises reliability. The network connection cables must be of good quality and shielded; the shield must be connected to ground at only one point. In networks that use two-wire cable over short distances, the use of twisted pair is acceptable.

There are two versions of converters on the market: one with a DIP switch to close the termination resistors and the other without a DIP switch or resistors. In the version without termination resistors, it is the user's responsibility to install the resistors directly on the connector cable of the last slave device in the network.

The value of these resistors must have an appropriate ohm value and must be connected between lines A / Ground and B / Ground.

### Using Modbus Slave Communications

#### Overview:

The ZYGGOT V5F allow the serial port to act as a Modbus/RTU slave. The Modbus function supports both ASCII and RTU modes (RTU configured by factory, ASCII under request) of operation across a range of baud rates and protocol frames. Also supported is port activity status, an in-activity timer and support for call-on-exception operation.

#### Basic Operation:

Before the Modbus function accepts messages, the Modbus must be activated pressing F5 (keyboard) for more than 3 seconds (Toggle).

Inactivity Timer:

The Modbus function contains a timer that is reset on the reception of a valid message addressed to this function. Should communications cease between the master and this function, that timer expires which sets an Inactivity timeout bit in the status word. Once communications is reestablished, both the timer and the Inactivity timeout bit in the status word are reset. Setting the timeout value to zero (at menu 13) disables this feature.

#### Report-on-exception:

Report-on-exception is a method of immediately informing the master that the slave has important information pending. This method is typically used in applications where modems are used as the communication channel, and the slaves are polled for data between long intervals. Once the connection is established, the master and slave require some cooperative functionality on determining the address of the slave calling. Since this functionality is not a standardized or a part of the Modbus protocol, the Modbus function contains two alternate methods such that the one most appropriate for the master is selected.

The first method involves the slave responding to the non-standard Modbus request Get Slave Address, which is broadcasted by the master after the connection is established. Since this is just a response to a Modbus request, this method does not require that Exception Messaging be enabled. This is method used by ZYGGOT. Use of this method with a third party master can require that master to be modified to support this command. The Modbus request and response frames are presented below:

#### Request:

ADDR	FUNC
0	65 (41H)

#### Response:

ADDR	FUNC	DATA
(SLAVE ADDR)	65(41H)	(SLAVE ADDR)

The second method involves the slave sending an unsolicited response (Exception Message) to the master once the connection is established (available only by request). The specific byte pattern used for the Exception Message depends on that supported by the master. When sent, the appropriate header and checksums are inserted automatically by the Modbus function. The Byte Count acts as the trigger that starts the transmission of the response. When the Byte Count transitions from zero to a specific number, that number of bytes are sent. Once transmitted, the Modbus function responds to master requests as expected.

#### Master Mapping:

To access a memory point or memory flag over Modbus, the master must be configured as to the point's type and offset. This is usually accomplished with one of two methods. The first method uses the traditional addressing scheme where the high digit represents the point's type and the lower digits represent the point's offset (starting with point 1). Since only four types can be represented in this manner, the Modbus function packs several data tables into a single point type array.

The Traditional RTU Reference column below specifies the starting address of each table. The second method requires the master to be configured with the specific Modbus command and offset. The supported Modbus commands and the associated offset are also illustrated below.

# MODBUS

Reference	Maximum Range	Modbus Reference	Modbus Command(s)	ModbusOffset
%I1	2048	10001	Read Input Status (2)	00000
%IG1	256	13001		03000
%S1	13	14001	Read Flag Status (1) Force Flag (5) Force Multiple Flags (15)	04000
%K1	4	15001		05000
%Q1	2048	00001		00000
%M1	2048	03001		03000
%T1	2048	06001	Read Input Register (4)	06000
%QG1	256	09001		90000
%AI1	512	30001		00000
%AIG1	32	33001		03000
%SR1	192	34001		04000
%Aq1	512	40001		00000
%R1	8192 (1024 Retentive)	43001	Read Holding Register (3) Load Register (6) Load Multiple Registers (16)	00000
%AQG1	32	46001		03000
				06000

## How to Connect a MODBUS slave device.

The physical device characteristics of the particular slave device determines the communications parameters required for connection. MODBUS is a multidrop communications protocol, (software), but typical RS-232 serial connections are not. RS-232 is basically a point-to-point hardware protocol with the transmit line of one device connected to the receive line of another device. Various combinations of protocol converters and/or modems may be used to multidrop RS-232 data links. Additionally, some serial cards may be configured to support 20 mA current loop for multidrop operation.

If a single slave device is to be connected, standard RS-232 hardware may be used. Depending upon the requirements of the master device, certain control signals may be required. These are typically RTS/CTS, (pins 4&5), or DTR/DSR/DCD, (pins 6,8 & 20). The ZYGGOT supports these control signals.

## Comm Port Buffering

The ZYGGOT firmware maintains a Transmit Buffer and a Receive Buffer. When a Send or Receive task is performed, data is transferred between the appropriate buffer and the program's registers.

For a Comm Port Transmit element, the TX Count word contains the number of characters moved from the program registers to the transmit buffer. This number can be less than the requested number if the comm port buffer is full.

For a Comm Port Receive element, the RX Count word contains the number of characters moved from the receive buffer in the program area. This number can be less than the requested number if the comm port buffer contains fewer characters than requested.

## Serial Port

The serial port physically present on the ZYGGOT unit is referred to as COMM1.

## Handshaking

Handshaking is a method whereby the destination end of a transmission can control how much and when data is sent to it.

**NOTE:** For purposes of this discussion, source end is defined as the unit which is transmitting data. Destination end is defined as the unit which actually receives the data.

Handshaking is configured on ZYGGOT V5FTA menu. There are five (5) possible types of handshaking:

**NONE** -- There is no handshaking. The source unit sends as many data bytes as it can as fast as possible for a given the baud rate. No consideration is given to the capabilities of the destination end.

**XON/XOFF** -- (Also called software handshaking) The destination end keeps track of how many characters it has received and the size of its

internal buffers. If the buffer gets full or the unit is otherwise unable to receive further characters, it must transmit the XOFF (transmit off) character. The source end must then stop transmitting data until a subsequent XON character is sent by the destination end.

Because there is some heavy software overhead involved, the timing of transmissions is variable. The destination must first determine that it is full and then transmit the XOFF signal. The source end must read the XOFF signal and react to it. In the mean time, several additional data bytes can be sent. It is up to the destination end to ensure that it sends the XOFF signal soon enough that the buffer is not overrun.

The XON and XOFF characters are predefined by the ASCII character set. XON is 11 hex or 17 decimal. XOFF is 13 hex or 19 decimal. The XON/XOFF handshaking is most often used where only ASCII values are being sent. XON/XOFF can not be easily used where binary data is involved, because the XON/XOFF codes are also valid binary codes.

Note that XON/XOFF handshaking usually implies a full duplex (both ends may transmit simultaneously) communications channel as the destination end needs to transmit the XOFF characters at any time (including in the middle of a transmission from the source end).

The advantage to XON/XOFF handshaking is that it can be implemented using an easy and cheap three-wire (TX/RX/Common) cable.

**HARDWARE** -- Also called RTS/CTS handshaking. Hardware handshaking requires extra signals be sent between the two units, thus this is more expensive to implement due to the increased numbers of wires in the interconnecting cables.

In operation, the destination end determines that it is empty, and activates its CTS (Clear To Send) signal. In response,

**HARDWARE** -- Also called **RTS/CTS handshaking**. Hardware handshaking requires extra signals to be sent between the two units, so it is more expensive to implement due to the increased number of wires in the interconnect cables.

In operation, the destination end determines that it is idle and asserts its **CTS (Clear To Send)** signal. In response, the source end sends data as long as the CTS signal remains active.

Many devices have the RTS/CTS signals hardwired directly into the hardware. Thus, an inactive CTS signal from the destination end can instantly shut down the source end. These hardware operations can be very fast because no software control is required in this case. Furthermore, this form of handshaking can be used regardless of the nature of the data being transmitted, ASCII or binary encoded.

**Full Duplex Multi-Drop** -- In a full-duplex multi-drop situation, all available units are connected in parallel. For the receiver circuitry, this is not a problem as long as the load on the network is not excessive. All units have their receivers enabled at all times.

Every message sent by the system is somehow identified by a receiving address. All units will receive all messages. All units check the delivery address against their own address and only the unit with the matching address responds.

When a unit determines that it has something to transmit, it turns on its transmitter, sends the necessary data packet, and then turns off its transmitter.

Full Duplex Multi-drop is typically found in multi-master or peer-to-peer systems where all units have a roughly equal chance of needing to transmit a message. Often, units need to verify that the message sent was sent correctly so that the receiver is on at all times.

The advantage of this system is that many units can be connected to a simple three-wire cable (RX/RX/Common). The disadvantage of this system is the increased complexity of the firmware and software.

**Half Duplex Multi-Drop** -- Half-Duplex Multi-Drop operation is identical to Full-Duplex, except that the transmitting unit's receiver is disabled when the unit is transmitting.

All units keep their transmitters disabled and receivers enabled at all times, except when they need to transmit. Typically, protocols dictate that only the unit corresponding to the drop address can transmit. This unit turns on its transmitter, turns off its receiver, sends the required data packet, then disables its transmitter and enables its receiver.

Half Duplex Multi-Drop is typically found in Master/Slave systems where one unit is designated the Master and all other units are Slaves. The Master transmits a message to a Slave, then disables its transmitter. All slaves hear the message, but only the slave with the matching "drop address" will turn on its transmitter and respond.

### Using RS-485 with ZYGGOT

ZYGGOT does not provide RS-485-compatible signals. You must purchase and install a third-party RS-232 to RS-485 converter or a Varixx converter.

In this mode, the transmitter is controlled by the ZYGGOT CTS signal, available on the DB-9 connector, Pin 8. When the ZYGGOT activates this signal, the converter enables its transmit section.

## DATA TYPES

In ZYGGOT V5FTA, data can be stored or used in several different formats. The format used depends on how the information is to be interpreted. Typical interpretations are binary bit patterns, unsigned numbers, signed numbers, floating point values, and strings.

Tipo	Nome	Descrição
------	------	-----------

**BOOL: Boolean** - A single BIT. Can contain only the values '0' or '1'.

**BYTE: Byte** - A string of 8 consecutive bits. Byte values are used where the data value is not as important as the bit patterns (shifts and rotations).

**WORD: Word** - A string of 16 consecutive bits. Word values are used where the data value is not as important as the bit patterns (shifts and rotations).

**DWORD: Double Word** - A string of 32 consecutive bits. DWORD values are used where the data value is not as important as the bit patterns (shifts and rotations).

**INT: Integer** - A 16-bit signed value. Integers are used where the data value is expected to be in the range -32,768 to +32,767

**SINT: Short Integer** - An 8-bit signed value. Short integers are used where the data value is expected to be in the range -128 to +127. **DINT: Double Integer** A 32-bit signed value. Double integers are used where the data value is expected to be in the range -2,147,483,648 to +2,147,483,647.

**UINT: Unsigned Integer** - A 16-bit unsigned value. Unsigned integers are used where the data value is expected to be in the range 0 (zero) to 65,535.

**USINT: Unsigned Short Integer** - An 8-bit unsigned value. Unsigned short integers are used where the data value is expected to be in the range 0 (zero) to 255.

**UDINT: Unsigned Double Integer** - A 32-bit unsigned value. Unsigned double integers are used where the data value is expected to be in the range 0 (zero) to 4,294,967,296.

**REAL Floating Point:** A 32-bit value. Values are stored and operated on in IEEE single-precision (six-digit) format. Values range from -3.40282E+38 to +3.40282E+38.

**STRING:** A variable-length sequence of characters. Each character is represented by one byte.

Bits in word registers can be used as boolean values. In this case, Bit Offset Addressing is used to specify the Register Type, Offset, and Bit Offset for the required bit.

Using boolean registers to represent real numbers is generally inefficient.

## STORAGE ORDER

32-bit values (DWORD, DINT, UDINT) occupy 32 consecutive bits of data or two (2) consecutive 16-bit registers. For example, if a DINT is defined in Register %R43, the 32-bit value is contained in both %R43 and %R44.

For 32-bit values, the data is stored low-order first. For example, if a DINT is defined in Register %R43 and contains the value "65540", (000000000000000001 0000000000000100) then Register %R43 will contain "4" and %R44 will contain "1".

Byte values (such as STRINGS) are stored high-order first. For example, to store the string "31" in Register %R43, store the HEX value 3133 (decimal 12595).



## Register Types

Controllers offer a wide variety of Register Types. In most cases, the controller treats register types as if they were memory locations. The following is a list of register types implemented normally available but not all are available for the user.

### **%AI Analog Input**

16-bit input registers used to gather analog input data such as voltages, temperatures, and speed settings coming from an attached device.

### **%AQ Analog Output**

16-bit output registers used to send analog information such as voltages, levels or speed settings to an attached device.

### **%I Digital Input**

Single-bit input registers. Typically, an external switch is connected to the registers.

### **%K Key Bit**

Single-bit flags used to give the programmer direct access to any front panel keys appearing on a unit. Only the OCS series has keypads.

### **%Q Digital Output**

Single-bit output registers. Typically, these bits are connected to an actuator, indicator light or alarm annunciator.

### **%R General Purpose Register**

Retentive 16-bit registers.

### **%S System Bit**

Single-bit bit coils predefined for system use.

### **%SR System Register**

16-bit registers predefined for system use.

### **%T Temporary Bit**

Non-retentive single-bit registers.

## Bit-Mapped Addressing of 32-bit Registers

Bit-mapped addressing of 32-bit registers is not allowed. Bit offset values range from 1 to 16.

In order to access all 32 bits in a double register it is necessary to address the upper word of the register separately. Storage is such that the lower word is stored in the first (base) register, and the upper word is stored in the next consecutive register.

For example, if the 32-bit binary 0000000000000001 000000000000100 value (65540 decimal) is loaded into register %R43, %R43 contains 0000000000000100 and %R44 contains 0000000000000001. Therefore, to check Bit 17 of the DWORD stored at %R43, one must check Bit 1 of %R44, addressed as %R44.1.

### Numbering Base

In ZYGGOT all offsets begin with 1 (one). 0 (zero) is not valid for register offset nor bit offset addressing.

Register offsets are thus in the range of 1 to X, where X is the maximum number of register in this model. For example, if the selected type has 2048 %R registers, they are addressed as %R01 through %R2048.

### Bit Offsets are in the range of 1 to 16.

Groups of Boolean registers can be accessed as a 16-bit register. In this case, though, the Bit offset must lie on a 16-bit boundary, 1, 17, 33, etc.

# RELAY ZYGGOT V5FTA MODBUS MAP

## MEMORY MAP FOR SERIAL COMMUNICATION

**READING STATE FLAGS (Coil M) - 1 Bit (ativo = 1)**  
**Ofset Padrão = 3000**  
**Reference - 3001**  
**(Read Only)**  
**(ACTIVE STATE)**

%M1 THM Sensor Net Comm. OK  
 %M2 THM SenS. Net Comm. Error  
 %M3 Clear Data  
 %M4 Restart Differential Data  
 %M5 On Flash (Liga Flash)  
 %M6 Reading Sensors  
 %M7 Off Flash (Desliga Flash)  
 %M8 Reserved  
 %M9 Reserved  
 %M10 Reserved  
 %M11 Reserved  
 %M12 Reserved  
 %M13 Reserved  
 %M14 Reserved  
 %M15 Reserved  
 %M16 Reserved  
 %M17 Reserved  
 %M18 Reserved  
 %M19 Reserved  
 %M20 Reserved  
 %M21 Net Mute Command  
 %M22 Net Reset Command  
 %M23 Diff. Read. Temp.  
 %M24 Simulating Diff.  
 %M30 Modbus Error  
 %M32 Modbus OK  
 %M42 State Alarm Active  
 %M43 State Trip Active  
 %M47 State Fail Active  
 %M57 THM Sensor Not Responding  
 %M59 Target Fail Active  
 %M60 Air Fail Active  
 %M63 All Sensor OK  
 %M65 Target Alarm  
 %M66 Target Trip  
 %M67 Air Alarm  
 %M68 Air Trip  
 %M69 Identify THM S. On State  
 %M70 Identify THM S. Off State  
 %M81 DI1 Input On  
 %M82 DI2 Input On  
 %M83 DI3 Input On  
 %M84 DI4 Input On  
 %M91 Mute Input On  
 %M92 Reset Input On  
 %M189 Gateway Inhibited  
 %M190 Gateway Output Trip ON  
 %M191 Gateway Nor Programmed  
 %M192 Gateway Armed  
 %M193 Gateway Alarm Active  
 %M194 Gateway Trip Active  
 %M195 Gateway Chain Input Active  
 %M196 Gateway Output 1 Active  
 %M197 Gateway Output 2 Active  
 %M198 Gateway Input 1 Active  
 %M199 Gateway Input 2 Active  
 %M200 Gateway Comm. Error  
 %M201 Gateway Comm. OK  
 %M230 Arc Sensor Not Resp. Active  
 %M232 Gateway Not Prog. Active  
 %M233 Arc Flash Active  
 %M236 Chain Command Active  
 %M241 State Group 1 Target Alarm  
 %M242 State Group 1 Air Alarm  
 %M243 State Group 2 Target Alarm  
 %M244 State Group 2 Air Alarm  
 %M245 State Group 3 Target Alarm  
 %M246 State Group 3 Air Alarm  
 %M247 State Group 4 Target Alarm  
 %M248 State Group 4 Air Alarm  
 %M249 State Group 5 Target Alarm  
 %M250 State Group 5 Air Alarm  
 %M251 to %M254 Reserved  
 %M252 Reserved  
 %M253 Reserved  
 %M254 Reserved  
 %M255 State Ext Fail 1 Alarm  
 %M256 State Ext Fail 2 Alarm  
 %M257 State Sensor Not Resp Alarm  
 %M258 Reserved

%M259 State Target Alarm  
 %M260 State Target Trip  
 %M261 State Air Alarm  
 %M262 State Air Trip  
 %M263 State Differential Alarm  
 %M264 State Differential Trip  
 %M265 State G1 Target Trip  
 %M266 State G1 Air Trip  
 %M267 State G2 Target Trip  
 %M268 State G2 Air Trip  
 %M269 State G3 Target Trip  
 %M270 State G3 Air Trip  
 %M271 State G4 Target Trip  
 %M272 State G4 Air Trip  
 %M273 State G5 Target Trip  
 %M274 State G5 Air Trip  
 %M275 Reserved  
 %M276 Reserved  
 %M277 Reserved  
 %M278 State Analog 1 Alarm  
 %M279 State Analog 1 Trip  
 %M280 State Analog 2 Alarm  
 %M281 State Analog 2 Trip  
 %M282 State Analog 3 Alarm  
 %M283 State Analog 3 Trip  
 %M284 State Analog 4 Alarm  
 %M285 State Analog 4 Trip  
 %M286 to %M293 Reserved  
 %M294 State System Operat. Hour  
 %M295 Modbus Error Alarm  
 %M296 Sensor Communication Fail  
 %M297 Auto Save Target Fail  
 %M298 Auto Save Air Fail  
 %M299 Memory Card Error  
 %M501a %M600 (THM S. Status (0=OK,1=NR))  
 %M669 Identify Arc S. ON  
 %M670 Identify Arc S. Off

**READING/WRITING STATE FLAGS (Coil M) - 1 Bit**  
**(active = 1)**  
**Ofset Padrão = 3000**  
**Reference - 3001**  
**(Read / Write)**

%M101 Plot 1 Restart  
 %M102 Plot 2 Restart  
 %M103 Plot 3 Restart  
 %M104 Plot 4 Restart  
 %M105 Plot 5 Restart  
 %M106 Plot 6 Restart  
 %M107 Plot 7 Restart  
 %M108 Plot 8 Restart  
 %M109 Plot 9 Restart  
 %M110 Plot 10 Restart  
 %M111 Plot 11 Restart  
 %M112 Plot 12 Restart  
 %M113 Plot 13 Restart  
 %M114 Plot 14 Restart  
 %M115 Plot 15 Restart  
 %M116 Plot 16 Restart  
 %M117 Plot 17 Restart

**READING/WRITING STATE FLAGS (Coil M) - 1 Bit**  
**(active = 1)**  
**Ofset Padrão = 3000**  
**Reference - 3001**  
**(Read / Write)**  
**(ACTIVE STATE)**

**ATTENTION:**  
**a) Valid only for software V05.71 and above.**  
**b) Valid only for Scan mode = Auto (In Manual Scan all flags will have a value of zero and the status of the selected Gateway can be read in Flag %M194)**

%M1601 Gateway 1 Trip Active  
 %M1602 Gateway 2 Trip Active  
 %M1603 Gateway 3 Trip Active  
 %M1604 Gateway 4 Trip Active  
 ~~~~~  
 to  
 ~~~~~  
 %M1640 Gateway 40 Trip Active

**READING/WRITING STATE FLAGS (Coil M) - 1 Bit**  
**(active = 1)**  
**Ofset Padrão = 3000**  
**Reference - 3001**  
**(Read / Write)**  
**(ACTIVE STATE)**

**ATTENTION:**  
**a) Valid only for software V05.71 and above.**  
**b) Once "1" is entered, the value is automatically reset to "0", operating as "Pulse".**

%M1301 Pulse command «Auto to Manual Scan Mode».  
 %M1302 Pulse command «Manual to Auto Scan Mode».  
 %M1303 Pulse command «Mute».  
 %M1304 Pulse command «Reset».

**READING/WRITING STATE FLAGS (Coil M) - 1 Bit**  
**(active = 1)**  
**Ofset Padrão = 3000**  
**Reference - 3001**  
**(Read / Write)**  
**(ACTIVE STATE)**

**ATTENTION:**  
**a) Valid only for software V05.71 and above.**  
**b) Valid only for Scan mode = Auto (In Manual Scan all flags will have a value of zero and the status of the sensors of the selected Gateway can be read in the Flags from %M801 to %M900)**

%M2001 - %M2096 GTWY 01 Sens.1 to 96 Arc  
 %M2097 - %M2192 GTWY 02 Sens.1 to 96 Arc  
 %M2193 - %M2288 GTWY 03 Sens.1 to 96 Arc  
 %M2189 - %M2384 GTWY 04 Sens.1 to 96 Arc  
 %M2385 - %M2480 GTWY 05 Sens.1 to 96 Arc  
 %M2481 - %M2576 GTWY 06 Sens.1 to 96 Arc  
 %M2577 - %M2672 GTWY 07 Sens.1 to 96 Arc  
 %M2673 - %M2768 GTWY 08 Sens.1 to 96 Arc  
 %M2769 - %M2864 GTWY 09 Sens.1 to 96 Arc  
 %M2865 - %M2960 GTWY 10 Sens.1 to 96 Arc

%M2961 - %M3056 GTWY 11 Sens.1 to 96 Arc  
 %M3057 - %M3152 GTWY 12 Sens.1 to 96 Arc  
 %M3153 - %M3248 GTWY 13 Sens.1 to 96 Arc  
 %M3249 - %M3344 GTWY 14 Sens.1 to 96 Arc  
 %M3345 - %M3440 GTWY 15 Sens.1 to 96 Arc  
 %M3441 - %M3536 GTWY 16 Sens.1 to 96 Arc  
 %M3537 - %M3632 GTWY 17 Sens.1 to 96 Arc  
 %M3633 - %M3728 GTWY 18 Sens.1 to 96 Arc  
 %M3729 - %M3824 GTWY 19 Sens.1 to 96 Arc  
 %M3825 - %M3920 GTWY 20 Sens.1 to 96 Arc

%M3921 - %M4016 GTWY 21 Sens.1 to 96 Arc  
 %M4017 - %M4112 GTWY 22 Sens.1 to 96 Arc  
 %M4113 - %M4208 GTWY 23 Sens.1 to 96 Arc  
 %M4209 - %M4304 GTWY 24 Sens.1 to 96 Arc  
 %M4305 - %M4400 GTWY 25 Sens.1 to 96 Arc  
 %M4401 - %M4496 GTWY 26 Sens.1 to 96 Arc  
 %M4497 - %M4592 GTWY 27 Sens.1 to 96 Arc  
 %M4593 - %M4688 GTWY 28 Sens.1 to 96 Arc  
 %M4689 - %M4784 GTWY 29 Sens.1 to 96 Arc  
 %M4785 - %M4880 GTWY 30 Sens.1 to 96 Arc

%M4881 - %M4976 GTWY 31 Sens.1 to 96 Arc  
 %M4977 - %M5072 GTWY 32 Sens.1 to 96 Arc  
 %M5073 - %M5168 GTWY 33 Sens.1 to 96 Arc  
 %M5169 - %M5264 GTWY 34 Sens.1 to 96 Arc  
 %M5265 - %M5360 GTWY 35 Sens.1 to 96 Arc  
 %M5361 - %M5456 GTWY 36 Sens.1 to 96 Arc  
 %M5457 - %M5552 GTWY 37 Sens.1 to 96 Arc  
 %M5553 - %M5648 GTWY 38 Sens.1 to 96 Arc  
 %M5649 - %M5744 GTWY 39 Sens.1 to 96 Arc  
 %M5745 - %M5840 GTWY 40 Sens.1 to 96 Arc

# RELAY ZYGOT V5FTA MODBUS MAP

## MEMORY MAP FOR SERIAL COMMUNICATION

### STATUS FLAGS READINGS (Coil M) - 1

Bit (active = 1)  
Default Offset = 3000  
Reference - 3001  
(Read Only)  
(PROGRAMMED FAILS)

%M237 Chaim Fail  
%M238 Remote 1 Command Fail  
%M239 Remote 2 Command Fail  
%M287 Arc Sensor N. Resp Fail  
%M289 Arc Flash Alarm Fail  
%M290 Arc Flash Trip Fail  
%M300 Gateway Not Prog Fail  
%M301 Fail Operating Hour  
%M302 Fail Sensor Comm.  
%M303 Fail Not Responding  
%M304 Reserved  
%M305 Reserved  
%M306 Fail Target Alarm  
%M307 Fail Target Trip  
%M308 Fail Air Alarm  
%M309 Fail Air Trip  
%M310 Fail Differ. Alarm  
%M311 Fail Analog 1 Alarm  
%M312 Fail Analog 2 Alarm  
%M313 Fail Analog 3 Alarm  
%M314 Fail Analog 4 Alarm  
%M315 Fail Analog 1 Trip  
%M316 Fail Analog 2 Trip  
%M317 Fail Analog 3 Trip  
%M318 Fail Analog 4 Trip  
%M319 Fail Ext Fail 1  
%M320 Fail Ext Fail 2  
%M321 Fail Differ. Trip  
%M322 Gateway Comm. Fail  
%M331 Fail G1 Air Alarm  
%M332 Fail G2 Air Alarm  
%M333 Fail G3 Air Alarm  
%M334 Fail G4 Air Alarm  
%M335 Fail G5 Air Alarm  
%M336 Fail G1 Air Trip  
%M337 Fail G2 Air Trip  
%M338 Fail G3 Air Trip  
%M339 Fail G4 Air Trip  
%M340 Fail G5 Air Trip  
%M341 Fail G1 Target Alarm  
%M342 Fail G2 Target Alarm  
%M343 Fail G3 Target Alarm  
%M344 Fail G4 Target Alarm  
%M345 Fail G5 Target Alarm  
%M346 Fail G1 Target Trip  
%M347 Fail G2 Target Trip  
%M348 Fail G3 Target Trip  
%M349 Fail G4 Target Trip  
%M350 Fail G5 Target Trip

### DATA READINGS (Register R)

(16-bit integers).  
Default Offset = 3000  
Reference = 43001  
(Read Only)

%R2001 Sensor 1 Target Temper.  
to  
%R2100 Sensor 100 Target Temper.  
  
%R2126 Sensor 1 Air Temper.  
to  
%R2225 Sensor 100 Air Temper.

### STATUS FLAGS READINGS (Coil M) - 1

Bit (active = 1)  
Default Offset = 3000  
Reference - 3001  
(Read Only)

%M401 Sensor Comm. OK  
%M402 Sensor Comm. Error  
%M403 Sensor Net Timeout  
%M404 Sensor Net Frame Parity  
%M405 Sensor Net CRC Check  
%M406 Sensor Net Unespect. Resp.  
%M407 Sensor Net Reject Comm.  
%M408 Sensor Net Reject Data  
%M409 Alarm Not Acknowledged  
%M410 Alarm Not Cleared  
%M411 Differential Function On  
%M412 Differential Warm OK  
%M413 Differential First Read Done  
%M414 Differential Read Valid  
%M415 Reserved  
%M416 Reserved  
%M417 Reserved  
%M418 Reserved  
%M419 Reserved  
%M420 Reserved  
%M421 Digital Input 1 On  
%M422 Digital Input 2 On  
%M423 Digital Input 3 On  
%M424 Digital Input 4 On  
%M425 EB1: Digital Input 1  
%M426 EB2: Digital Input 2  
%M427 EB3: Digital Input 3  
%M428 EB4: Digital Input 4  
%M429 EB5: Digital Input 5  
%M431 EB6: Digital Input 6  
%M431 EB7: Digital Input 7  
%M432 EB8: Digital Input 8  
%M433 to %M440 Reserved  
%M441 Digital Output 1 MUTE  
%M442 Digital Output 2 RESET  
%M443 Digital Output 3 D.O.3  
%M444 Digital Output 4 D.O.4  
%M445 EB1: AUX 1  
%M446 EB2: AUX 2  
%M447 EB3: AUX 3  
%M448 EB4: AUX 4  
%M449 EB5: AUX 5  
%M450 EB6: AUX 6  
%M451 EB7: AUX 7  
%M452 EB8: AUX 8  
%M453 to %M 460 Reserved  
%M1101 to %M1140 Gateways Status

Tipo de dado MODBUS	Tamanho
Coil	1 bit
Holding Register	16 bits

Tipos de dados MODBUS	Função	Código
Coil	Leitura	0x01
	Escrita	0x05
Holding Register	Leitura	0x03
	Escrita	0x06

### STATUS FLAGS READINGS (Coil M) - 1

Bit (active = 1)  
Default Offset = 3000  
Reference - 3001  
(Read Only)

%M501 to %M600 THM S. Status (0=OK,1=NR)  
%M701 to %M800 ARC S. Status (0=OK,1=NR)  
%M801 to %M900 (S.Arc Flash(0=OK,1=Flash))

### FLAGS DE ESTADO (R) - 1 Bit

(Não mapeáveis no protocolo normal).  
Nota: Ler Registro 16 Bits Normalmente. Offset Padrão 3000  
Reference = 43001  
e testar valor do Bit 2.  
(Read Only)

%R5001.2 Target Alarm Sensor 1  
to  
%R5100.2 Targe Alarm Sensor 100  
  
%R6001.2 Target Trip Sensor 1  
to  
%R6100.2 Targe Trip Sensor 100  
  
%R7001.2 Air Alarm Sensor 1  
to  
%R7100.2 Air Alarm Sensor 100  
  
%R8001.2 Air Trip Sensor 1  
to  
%R8100.2 Air Trip Sensor 100

### DATA READINGS (Register R)

(16-bit integers).  
Default Offset = 3000  
Reference = 43001  
(Read Only)

%R981 H. On at Diff Start (32 Bit)  
%R987 M. On at Diff Start (16 Bit)  
%R985 Total Diff Time Hour (32 Bit)  
%R988 Total Diff Time Min. (16 Bit)  
%R1915 Time to Warm Hour (16 Bit)  
%R1913 Time to Warm Min. (16 Bit)  
%R1007 Time to Restart H. (16 Bit)  
%R1003 Time to Restart M. (16 Bit)  
%R1081 > Target Temperature. (16 Bit)  
%R1082 > Air Temperature (16 Bit)  
%R1330 N. Sensors THM Resp. (16 Bit)  
%R1333 N. Sens. THM Not Resp (16 Bit)  
%R1079 Total Alarms (16 Bits)  
%R1083 Total Trips (16 Bits)  
%R1411 Total Sensors Responding p/GTWY  
%R1412 Total Sensors Not Resp. p/ GTWY  
%R1429 Total Arc Flash Not Cleared All GTWY  
%R1526 First Fail On Gateway (16 Bit)  
%R3051 Analog 1 Value (16 Bit)  
%R3053 Analog 2 Value (16 Bit)  
%R3053 Analog 3 Value (16 Bit)  
%R3054 Analog 4 Value (16 Bit)  
%R1192 =1 // Unity = % (16 Bit)  
%R1192 =2 // Unity = °C (16 Bit)  
%R1192 =4 // Unity =°F (16 Bit)  
%R2001 to %R2100 THM Sensor Temperature  
%R2126 to %R2225 Air temperature (to V5.70)  
%R2101 to %R 2200 Air Temperature (V5.71 and up)  
%R4401 to %R4500 Arc Sensor Voltage (xx.xx)  
%R4501 to %R4600 T. Sensor Voltage (xx.xx)  
%R6401 to %R6400 Arc Flash Sequence Index

# RELAY ZYGGOT V5FTA MODBUS MAP

## MEMORY MAP FOR SERIAL COMMUNICATION

### PARAMETERS (Register R)

Menu: RELAY CONFIG

Default Offset = 3000

Reference = 43001

(Read / Write)

%R801 Language  
(0=English/1=Português/2=Espanhol)  
%R879 Screen Brightness (50-100%)  
%R790.2 Save Screen (0=No/1=Yes)  
%R860 Save Screen Time (5-200 min)  
%R881 Saving Brightness (5-50%)  
%R760 - %R764 Plant (10 Bytes ASCII)  
%R770 - %R774 Location (10 Bytes ASCII)  
%R780 - %R784 Panel (10 Bytes ASCII)  
%R809 Memory Card Error Action  
(0=None/1=Log)

### PARAMETERS (Register R)

Menu: RELAY CONFIG

Default Offset = 3000

Reference = 43001

(Read / Write)

%R790.1 Centigrades / Fahrenheit (0/1)  
%R802 Reset On Fail Unacknowledged  
(0=No/1=Yes)  
%R840 Reset On Fail Active (0=No/1=Yes)  
%R803 Wait If Flash = On (0=No/1=Yes)  
%R804 Air Alarm Level (0-999)  
%R805 Air Trip Level (0-999)  
%R806 Call Screen On Fail (0=No/1=Yes)  
%R807 Call Screen On Alarm (0=No/1=Yes)  
%R1010.1 Reserved  
%R1010.2 Reserved  
%R808 Return to Main Time (0=no/0-3600 s)

### PARAMETERS (Register R)

Menu: BLOCK PROGRAMING

Ofsett Padrão = 3000

Reference = 43001

(Read / Write)

%R811 Block 1 Start (1-100)  
%R812 Block 1 End (1-100)  
%R821 Block 1 Target Alarm (0-999)  
%R821 Block 1 Target Trip (0-999)

%R813 Block 2 Start (1-100)  
%R814 Block 2 End (1-100)  
%R823 Block 2 Target Alarm (0-999)  
%R824 Block 2 Target Trip (0-999)

%R815 Block 3 Start (1-100)  
%R816 Block 3 End (1-100)  
%R825 Block 3 Target Alarm (0-999)  
%R826 Block 3 Target Trip (0-999)

%R817 Block 4 Start (1-100)  
%R818 Block 4 End (1-100)  
%R827 Block 4 Target Alarm (0-999)  
%R828 Block 4 Target Trip (0-999)

%R819 Block 5 Start (1-100)  
%R820 Block 6 End (1-100)  
%R829 Block 7 Target Alarm (0-999)  
%R830 Block 8 Target Trip (0-999)

### PARAMETERS (Register R)

Menu: RELAY CONFIG

Default Offset = 3000

Reference = 43001

(Read / Write)

%R841 Baud Rate (1=  
9600/2=19200/4=38400)  
%R842 Address (1-247)  
%R843 Parity (1=None/2=Odd/4=Even)  
%R844 Handshake  
(1=None/2=XON/XOF/4=CTS/RTS/8=MD/Half)  
%R845 Timeout (0-1023 s)  
%R846 Stop Bits (1=1/2=2)  
%R847 Port Mode (1=RS232)  
%R848 Modbus (0=Inactive/1=Active)

### PARAMETERS (Register R)

Menu: RELAY CONFIG

Default Offset = 3000

Reference = 43001

(Read / Write)

%R835 Scale (0-9999)  
%R836 Index Mode (0=Display/1=Menu)  
%R837 HMI Reset (0=Disable/1=Enable)  
%R838.1 Enable Retentive (0=No/1=Yes)  
%R851 Index 3A-7A (1-100)  
%R852 Index 3B-7B (1-100)  
%R853 Index 3C-7C (1-100)  
%R854 Index 8A-12A (1-100)  
%R855 Index 8B-12B (1-100)  
%R856 Index 8C-12C (1-100)

### PARAMETERS (Register R)

Menu: RELAY CONFIG

Default Offset = 3000

Reference = 43001

(Read / Write)

%R810 Total Sensor Number (3-100)  
%R891 Auto Save Target Data (0/1)  
%R892 Auto Save Air Data (0/1)  
%R850 Save Methode (0=Always to the Same  
File/1=New File Each Start)  
%R859 Save Period (10-1440 m)  
%R839 Start New File (0=No/1=Yes)  
%R849 Read Write Fail Action (0=None/1=Log)

### PARAMETROS (Register R)

Menu: ANALOG INPUTS

Default Offset = 3000

Reference = 43001

(Read / Write)

%R751 - %R753 Ai1 Name (6 Bytes ASCII)  
%R754 - %R756 Ai2 Name (6 Bytes ASCII)  
%R757 - %R759 Ai3 Name (6 Bytes ASCII)  
%R787 - %R790 Ai4 Name (6 Bytes ASCII)  
%R831 Read Mode (0=%/1=Temp)  
%R832 Scale (10 - 99999)

### ARC PARAMETERS (Register R)

Menu: PARAMETERS CONFIG

Default Offset = 3000

Reference = 43001

(Read / Write)

**Options to Digital Output** (0 = None, 1 = D.O.3,  
2 = D.O.4, 2 = EB1:AUX 1, 4 = EB2:AUX2, 8 =  
EB3:AUX 3, 16 = EB1:AUX, 32 = EB4:AUX 4, 64  
= EB5:AUX 5, 128 = EB6:AUX 6, 256 = EB7:AUX  
7,512 = EB8:AUX8)

%R200 Gateway Number (1 - 49)  
%R206 Remote 1 Out Mode (0 = None, 1 =  
Alarm From Relay, 2 = Trip From Relay)  
%R207 Remote 2 Out Mode (0 = None, 1 =  
Alarm From Relay, 2 = Trip From Relay)  
%R208 Chain Input Action (None, 1 = Arc  
Flash, 2 = Alarm Relay, 4 = Trip Relay)  
%R209 Chain Fail D. Out (0 = none, 1 = Log, 2  
= Alarm)  
%R214 Scan Mode (0 = On Fail do Scan, On  
Fail Stop Scan).  
%R789 Gateway Modbus Term Res. (0 =  
Disable, 1 = Enable)  
%R941 System Type (1 = THM Only, 2 = ARC  
Only, 4 = THM+ARC)  
%R942 ARC Sensor Number (1 to 100)  
%R943 Gateway Comm Action (0 = None, 1 =  
Log, 2 = Alarm)  
%R944 Gateway Comm. D. Out (see above)  
R957 Gateway Not Prog Action (0 = None, 1 =  
Log, 2 = Alarm)  
%R945 Arc Flash Action (0 = None, 1 = Log, 2  
= Alarm, 4 = Trip)  
%R946 Arc Flash D. Out (see above)  
%R957 Gateway Not Prog Action.  
%R958 Gateway Not Prog D. Out (see above)  
%R989 Gateway Trip Mode (0 = Retentive, 1=  
Pulse 3s)  
%R990 Gateway Out 1 Mode (1 = Trip, 2 =  
Armed, 4 = Alarm, 8 = Remote 1)  
%R995 Gateway S. N.R. Action (0 = none, 1 =  
Log, 2 = Alarm)  
%R996 Gateway S. N.R. D. Out (see above)  
%R997 Gateway Programm (0 = Disabel, 1 =  
Enable)  
%R1000 Gateway Out 2 Mode (1 = trip, 2 =  
Armed, 4 = Alarm, 8 = Remote 2)  
%R1001 Gateway Imp 1 Mode (0 = None, 1 =  
Reset)  
%R1002 Gateway Imp 2 Mode (0 = None, 2 =  
Reset, 4 = Inhibit, 8 = Chain)  
%R1411 Arc S. Responding Number  
%R1412 Arc S. Not Resp. Number  
%R1465 Total Arc Flash Not Cleared  
%R3201 to %R3240 Sensor Number each  
Gateway

## MEMORY MAP FOR SERIAL COMMUNICATION

### PARAMETERS (Register R)

Menu: PROTECTIONS

Default Offset = 3000

Reference = 43001

(Read / Write)

Opções p/ Alarm Action: (0=None / 1=Log / 2=Alarm)

Opções para Trip Action: (0=None / 1=Log / 4=Trip)

Opções p/ D. Output: (0=None / 1=D.O.3 / 2=D.O.4 / 4=Aux1 / 8=Aux2 / 16=Aux3 / 32=Aux4 / 64=Aux5 / 128=Aux6 / 256=Aux7 / 512=Aux8)

%R862 Note Respond Action  
 %R863 Note Resp. D. Output  
 %R864 Target Alarm Action  
 %R865 Target Alarm D. Output  
 %R868 Note Respond Action  
 %R869 Note Resp. D. Output  
 %R866 Air Alarm Action  
 %R867 Air Alarm D. Output  
 %R870 Air Trip Action  
 %R871 Air Trip D. Output  
 %R877 Sensor Comm. Fail Action  
 %R878 Sensor Comm Fail D. Output  
 %R857 Modbus Comm. Fail Action  
 %R858 Modbus Comm. Fail Aux Output

%R1020 Differential - Execute Diff (0=Non/1=Yes)  
 %873 Differential Alarm Level (0-200%)  
 %874 Differential Trip Level (0-200%)  
 %R1016 Differential Alarm Action  
 %R1017 Differential Trip Action  
 %R875 Differential Warmup Hours (0-50 h)  
 %R1018 Differential Restart Period (0-10000 h) (0=No)  
 %R876 Differential D. Output

%R880 Operating Time Action  
 %R893 Operating Time Level (0- 250000 h)

### PARAMETERS (Register R)

Menu: TARGET ALARM LEVELS

Default Offset = 3000

Reference = 43001

(Read / Write)

%R501 Sensor 1 Target Alarm Level (0-999)  
 %R502 Sensor 2 Target Alarm Level (0-999)  
 ===  
 %R600 Sensor 100 Target Alarm Level (0-999)

### PARAMETERS (Register R)

Menu: TARGET TRIP LEVELS

Default Offset = 3000

Reference = 43001

(Read / Write)

%R626 Sensor 1 Target Trip Level (0-999)  
 %R627 Sensor 2 Target Trip Level (0-999)  
 ===  
 %R725 Sensor 100 Target Trip Level (0-999)

### PARAMETERS (Register R)

Menu: PROTECTIONS GROUP

Default Offset = 3000

Reference = 43001

(Read / Write)

Opções p/ Alarm Action: (0=None / 1=Log / 2=Alarm)

Opções para Trip Action: (0=None / 1=Log / 4=Trip)

Opções p/ Aux Output: (0=None / 1=D.O.3 / 2=D.O.4 / 4=Aux1 / 8=Aux2 / 16=Aux3 / 32=Aux4 / 64=Aux5 / 128=Aux6 / 256=Aux7 / 512=Aux8)

%R901 Group 1 Target Alarm Action  
 %R906 Group 1 Target Trip Action  
 %R911 Group 1 Air Alarm Action  
 %R916 Group 1 Air Trip Action  
 %R921 Group 1 Target Alarm D. Output  
 %R926 Group 1 Target Trip D. Output  
 %R931 Group 1 Air Alarm D. Output  
 %R936 Group 1 Air Trip D. Output

%R902 Group 2 Target Alarm Action  
 %R907 Group 2 Target Trip Action  
 %R912 Group 2 Air Alarm Action  
 %R917 Group 2 Air Trip Action  
 %R922 Group 2 Target Alarm D. Output  
 %R927 Group 2 Target Trip D. Output  
 %R932 Group 2 Air Alarm D. Output  
 %R937 Group 2 Air Trip D. Output

%R903 Group 3 Target Alarm Action  
 %R908 Group 3 Target Trip Action  
 %R913 Group 3 Air Alarm Action  
 %R918 Group 3 Air Trip Action  
 %R923 Group 3 Target Alarm D. Output  
 %R928 Group 3 Target Trip D. Output  
 %R933 Group 3 Air Alarm D. Output  
 %R938 Group 3 Air Trip D. Output

%R904 Group 4 Target Alarm Action  
 %R909 Group 4 Target Trip Action  
 %R914 Group 4 Air Alarm Action  
 %R919 Group 4 Air Trip Action  
 %R924 Group 4 Target Alarm D. Output  
 %R929 Group 4 Target Trip D. Output  
 %R934 Group 4 Air Alarm D. Output  
 %R939 Group 4 Air Trip D. Output

%R905 Group 5 Target Alarm Action  
 %R910 Group 5 Target Trip Action  
 %R915 Group 5 Air Alarm Action  
 %R920 Group 5 Air Trip Action  
 %R925 Group 5 Target Alarm D. Output  
 %R930 Group 5 Target Trip D. Output  
 %R935 Group 5 Air Alarm D. Output  
 %R940 Group 5 Air Trip D. Output

### PARAMETERS (Register R)

Menu: PROTECTIONS ANALOG

Default Offset = 3000

Reference = 43001

(Read / Write)

Opções p/ Alarm Action: (0=None / 1=Log / 2=Alarm)

Opções para Trip Action: (0=None / 1=Log / 4=Trip)

Opções p/ Aux Output: (0=None / 1=D.O.3 / 2=D.O.4 / 4=Aux1 / 8=Aux2 / 16=Aux3 / 32=Aux4 / 64=Aux5 / 128=Aux6 / 256=Aux7 / 512=Aux8)

%R961 Analog 1 Alarm Action  
 %R883 Analog 1 Alarm Level High (0-100 %)  
 %R969 Analog 1 Alarm D. Output  
 %R965 Analog 1 Trip Action  
 %R887 Analog 1 Trip Level High (0-100 %)  
 %R973 Analog 1 Trip D. Output

%R962 Analog 2 Alarm Action  
 %R884 Analog 2 Alarm Level High (0-100 %)  
 %R970 Analog 2 Alarm D. Output  
 %R966 Analog 2 Trip Action  
 %R888 Analog 2 Trip Level High (0-100 %)  
 %R974 Analog 2 Trip D. Output

%R963 Analog 3 Alarm Action  
 %R854 Analog 3 Alarm Level High (0-100 %)  
 %R971 Analog 3 Alarm D. Output  
 %R967 Analog 3 Trip Action  
 %R889 Analog 3 Trip Level High (0-100 %)  
 %R975 Analog 3 Trip D. Output

%R964 Analog 4 Alarm Action  
 %R855 Analog 4 Alarm Level High (0-100 %)  
 %R972 Analog 4 Alarm D. Output  
 %R968 Analog 4 Trip Action  
 %R890 Analog 4 Trip Level High (0-100 %)  
 %R976 Analog 4 Trip D. Output

### PARAMETERS (Register R)

Menu: PROTECTIONS EXTERNAL FAIL

Default Offset = 3000

Reference = 43001

(Read / Write)

Opções para Alarm Action (0=None/1=Log/2=Alarm)

Opções para Trip Action (0=None/1=Log/4=Trip)

Opções p/ D. Output (0=None / 1=D.O.3 / 2=D.O.4 / 4=Aux1 / 8=Aux2 / 16=Aux3 / 32=Aux4 / 64=Aux5 / 128=Aux6 / 256=Aux7 / 512=Aux8)

%R977 External Fail 1 Action  
 %R983 External Fail 1 Trip Delay (0-999 x 0,1 s)  
 %R979 External Fail D. Output  
 %R767 - %R769 External Fail Assign Name (6 Bytes ASCII)

%R978 External Fail 1 Action  
 %R984 External Fail 1 Trip Delay (0-999 x 0,1 s)  
 %R980 External Fail D. Output  
 %R777 - %R779 External Fail Assign Name (6 Bytes ASCII)

## GENERAL SPECIFICATIONS

### OVERVIEW

- The protocol is standard Modbus RTU over RS-485.
- Sensor must be configured by an USB cable prior to communication.
- Every sensor must have a unique address in the network.
- Address 0 (zero) is reserved to broadcast messages to all sensors.
- Registers are signed integers with 16 bits precision.
- Registers have more than one address and can be accessed in more than one way in order to facilitate its utilization.
- The Target temperature are always corrected by emissivity value.

### SERIAL CONFIGURATION

**Baud rate:** 1200; 2400; 4800; 9600; 19200; 38400; 57600; 115200

**Data bits:** 8

**Parity:** No; Even; Odd

**Stop bits:** 0.5; 1; 1.5; 2

### ADDRESS TABLE

#### Coil (Modbus function 01)

Address	Name	Description
27 (0x001B)	Blink	Blink control: 0-off 1-on
2560 (0x0A00)	Term_Res	RS-485 Termination Res. Control: 0-off 1-on

#### HOLDING REGISTER

#### (Modbus function 03)

Address	Name	Description
27 (0x001B)	Blink	Blink control: 0-off 1-on
2560 (0x0A00)	Term_Res	RS-485 Termination Resistor control: 0-off 1-on
256 (0x0100)	Emissivity	Emissivity multiplier divided by 100: 0 to 200 (default 95 -> read value = measure / 0.95)
21 (0x0015)	User_1	Retentive free use 1
22 (0x0016)	User_2	Retentive free use 2
23 (0x0017)	User_3	Retentive free use 3
24 (0x0018)	User_4	Retentive free use 4

### INPUT REGISTER

#### (Modbus function 04)

Address	Name	Description
1 (0x0001)		
30001 (0x7531)	Version	Sensor version (0x0102 = 1.02)
2 (0x0002)		
30002 (0x7532)	Column_and_Sensor	Sensor column and number (auxiliary)
3 (0x0003)		
30003 (0x7533)	Status	Bit[15-3]: Reserved Bit[2]: Blink(0-off 1-on) Bit[1]: Termination Resistor (0-off 1-on) Bit[0]: Check (1-OK)
4 (0x0004)		
30004 (0x7534)	Target_C_10	Target temperature in Celsius multiplied by 10 (367 = 36.7°C)
5 (0x0005)		
30005 (0x7535)	Environment_C_10	Environment temperature in Celsius multiplied by 10 (253 = 25.3°C)
6 (0x0006)		
30006 (0x7536)	Target_F_10	Target temperature in Fahrenheit multiplied by 10 (982 = 98.2°C)
7 (0x0007)		
30007 (0x7537)	Environment_F_10	Environment temperature in Fahrenheit multiplied by 10 (775 = 77.5°C)
8 (0x0008)		
30008 (0x7538)	Target_C	Target temperature in Celsius (36 = 36°C)
9 (0x0009)		
30009 (0x7539)	Environment_C	Environment temperature in Celsius (25 = 25°C)
10 (0x000A)		
30010 (0x753A)	Target_F	Target temperature in Fahrenheit (98 = 98°C)
11 (0x000B)		
30011 (0x753B)	Environment_F	Environment temperature in Fahrenheit (77 = 77°C)
12 (0x000C)		
30012 (0x753C)	V_Bus_100	Bus Tension in Volts multiplied by 100 (2341 = 23.41V)

# ARC GATEWAY MODBUS SPEC

## GENERAL SPECIFICATIONS

### Input Register (Modbus function 04) (read-only)

OFFSET	WORD = 16 BIT										0 a 100 sensores								
	32768	16384	8192	4096	2048	1024	512	256	128										
1	16	15	14	13	12	11	10	9	8										
1	Version (value 100 = 1.00)																		
2	Serial Number 32bits - LSB																		
3	Serial Number 32bits - MSB																		
4	Manufacture Day																		
5	Manufacture Month																		
6	Manufacture Year																		
7	Manufacture Lot																		
8	Manufacture User 1																		
9	Manufacture User 2																		
10	Manufacture User 3																		
11	Manufacture User 4																		
12	Sensor Number (Last Sensor Of Network)																		
13	Trip List Size																		
100	OUT TRIP	OUT 2	OUT 1	IN 2	IN 1	Any Sensor Not Responmding	Any Sensor Configured	Any Sensor Trip	CHAIN 0= None , 1= Chain)	Trip Sequence Size (0=none)									
101	OUT TRIP	OUT 2	OUT 1	IN 2	IN 1	Sensor 1 Not Responding	Sensor 1 Configured	Sensor 1 Trip		Sensor 1 Trip Sequence (0=No 1=First N=Position)									
102	TRIP	OUT 2	OUT 1	IN 2	IN 1	Sensor 2 Not Responding	Sensor 2 Configured	Sensor 2 Trip		Sensor 2 Trip Sequence (0=No 1=First N=Position)									
199	TRIP	OUT 2	OUT 1	IN 2	IN 1	Sensor 99 Not Responding	Sensor 99 Configured	Sensor 99 Trip		Sensor 99 Trip Sequence (0=No 1=First N=Position)									
200	TRIP	OUT 2	OUT 1	IN 2	IN 1	Sensor 100 Not Responding	Sensor 100 Configured	Sensor 100 Trip		Sensor 100 Trip Sequence (0=No 1=First N=Position)									
201	Trip List 1 (0=None N=Sensor)																		
202	Trip List 2 (0=None N=Sensor)																		
299	Trip List 99 (0=None N=Sensor)																		
300	Trip List 100 (0=None N=Sensor)																		
301	Sensor 1 Version (100=1.00)																		
302	Sensor 2 Version (100=1.00)																		
399	Sensor 99 Version (100=1.00)																		
400	Sensor 100 Version (100=1.00)																		
401	Sensor 1 Level																		
402	Sensor 2 Level																		
499	Sensor 99 Level																		
1010	0																		
1011	Event 1 - Sequence ID																		
1012	Event 1 - Sensor Number																		
1013	Event 1 - Timestamp Day																		
1014	Event 1 - Timestamp Month																		
1015	Event 1 - Timestamp Year																		
1016	Event 1 - Timestamp Hour																		
1017	Event 1 - Timestamp Minute																		
1018	Event 1 - Timestamp Seconds																		
1019	Event 1 - Repeat Count																		
1500	0																		
1501	Event 50 - Sequence ID																		
1502	Event 50 - Sensor Number																		
1503	Event 50 - Timestamp Day																		
1504	Event 50 - Timestamp Month																		
1505	Event 50 - Timestamp Year																		
1506	Event 50 - Timestamp Hour																		
1507	Event 50 - Timestamp Minute																		
1508	Event 50 - Timestamp Seconds																		
1509	Event 50 - Repeat Count																		

# ARC GATEWAY MODBUS SPEC

## GENERAL SPECIFICATIONS



OFFSET	WORD = 16 BIT												Default Hex											
	16	15	14	13	12	11	10	9	8	7	6	5		4	3	2	1							
1	Trip Mode	OUT_2 Mode B2	OUT_2 Mode B1	OUT_1 Mode B2	OUT_1 Mode B1	IN_2 Mode B2	IN_2 Mode B1	IN_1 Mode	Sensor Network Size (0...100) (Last Sensor Of Network)								0x0000							
	0 → Keep On	B2=0 B1=0 → Trip	B2=0 B1=0 → Trip	B2=0 B1=0 → Trip	B2=0 B1=0 → Trip	B2=0 B1=0 → None	B2=0 B1=0 → None	0 → None	BIT 1 - 8 = 0 a 100 sensores															
	1 → Pulse 3 Sec	B2=0 B1=1 → Alarm (No Trip)	B2=0 B1=1 → Armed (No Trip)	B2=0 B1=1 → Armed (No Trip)	B2=0 B1=1 → Reset	B2=1 B1=0 → Inhibits/Disable Trip	B2=1 B1=0 → Inhibits/Disable Trip	1 → Reset																
		B2=1 B1=0 → Alarm	B2=1 B1=0 → Alarm	B2=1 B1=0 → Alarm	B2=1 B1=0 → Alarm	B2=1 B1=1 → Chain	B2=1 B1=1 → Chain																	
2	x	x	x	x	x	x	x	Blink Active	Sensor to Blink (0=All)								0x0000							
								0=no / 1=Blink	BIT 1 - 8 = 0 a 100 sensores															
3	Unlock Bits 12 to 15	Force Out/Trip SCR	Force Out/Trip Relay	Force OUT 2	Force OUT 1	Remote 2	Remote 1	x	x	x	x	x	x	x	x	x	Reset Trip							
	0=no / 1=Unlock	0=no / 1=force	0=no / 1=force	0=no / 1=force	0=no / 1=force	0=Off / 1=On	0=Off / 1=On	0=no / 1=Reset	RS485 Gateway Modbus Address - SLAVE ID (Initial = 200)															
4	Unlock	Terminator RS485	Baudrate Mode B3	Baudrate Mode B2	Baudrate Mode B1	Parity Mode B2	Parity Mode B1	Stop Bit Mode									RS485 Gateway Modbus Address - SLAVE ID (Initial = 200)							
	0 → Read-only	0 → No Resistor	B3=0 B2=0 B1=0 → 1200	B3=0 B2=0 B1=0 → 1200	B2=0 B1=0 → None	0 → 1 stop bits	0 → 1 stop bits																	
	1 → Enable Bits 1 to 14	1 → 120R Resistor	B3=0 B2=0 B1=1 → 2400	B3=0 B2=0 B1=1 → 2400	B2=0 B1=1 → Even	1 → 2 stop bits	1 → 2 stop bits																	
			B3=0 B2=1 B1=0 → 4800	B3=0 B2=1 B1=0 → 4800	B2=1 B1=0 → Odd																			
			B3=0 B2=1 B1=1 → 9600	B3=0 B2=1 B1=1 → 9600																				
		B3=1 B2=0 B1=0 → 19200	B3=1 B2=0 B1=0 → 19200																					
		B3=1 B2=0 B1=1 → 38400	B3=1 B2=0 B1=1 → 38400																					
		B3=1 B2=1 B1=0 → 57600	B3=1 B2=1 B1=0 → 57600																					
		B3=1 B2=1 B1=1 → 115200	B3=1 B2=1 B1=1 → 115200																					
5	Clock Control (0=KEEP, 1=READ, 2=WRITE)																							
6	Clock Day (1...31)																							
7	Clock Month (1..12)																							
8	Clock Year (1..3000)																							
9	Clock Hour (0..24)																							
10	Clock Minute (0...60)																							
11	Clock Second (0...60)																							
12	Manufacture Write Unlock Password (Enable change registers 21 to 30)																							
13	Serial Number 32bits - LSB																							
14	Serial Number 32bits - MSB																							
15	Manufacture Day																							
16	Manufacture Month																							
17	Manufacture Year																							
18	Manufacture Lot																							
19	Manufacture User 1																							
20	Manufacture User 2																							
21	Manufacture User 3																							
22	Manufacture User 4																							
23	Clear All Saved Event																							

# MODBUS OVER ETHERNET TCP IP SERVER



## GENERAL SPECIFICATIONS (PART 1 / 4)

MODBUS OVER ETHERNET ETHERNET IP SERVER - COMMUNICATION WILL WORK WITH PLCs AND ALLEN BRADLEY PROTOCOL OR ALLEN BRADLEY LIKE  
 Maximum connection = 2 // PORT = 44818 TCP or 2222 UDP.  
 SEND (PRODUCED) FIRST REGISTER = %R2801 /// LAST REGISTER = %R2928 /// WORDS COUNT = 128.  
 RECEIVE (CONSUMED) FIRST REGISTER = %R3201 /// LAST REGISTER = %R3328 /// WORDS COUNT = 128.  
 The Status word provides Ethernet/IP connection status. The upper byte of the word contains the Class 3 (Explicit) connection count and the lower byte contains the Class 1 (IO) connection count.

NOTE: When the Status word indicates no connections, the Consumed OCS registers contain old data.  
 As up to 128 words are allowed in each communication, a pagination scheme is used to access all important and available data.  
 In this version, parameter programming via the Ethernet connection is not allowed, so the variable on the corresponding screen is permanently set to "Disabled".  
 However, it is allowed to send some commands via the Ethernet connection, in addition to specifying the page to be read.

CONSUMED	Controller Tags	WRITE PAGE		FUNCTION	MULTIPLE GATEWAY VERSION		NOTE	WARNING
		1 TO 16	RESERVED FOR FUTURE USE		DATA			
%R3301	O.Data[100]	0	MUTE	1= MUTE // 0 = DO NOTHING			SEND COMMAND MUTE TO RELAY	
%R3302	O.Data[101]	0	RESET	1= RESET // 0 = DO NOTHING			SEND COMMAND RESET TO RELAY	
%R3303	O.Data[102]	0	SAVE TARGET	1= SAVE // 0 = DO NOTHING			SAVE TARGET DATA TO MEMORY CARD	
%R3304	O.Data[103]	0	SAVE AIR	1= SAVE // 0 = DO NOTHING			SAVE AIR DATA TO MEMORY CARD	
%R3305	O.Data[104]	0	GATEWAY SCAN AUTO	1= CHANGE TO SCAN AUTO // 0 = DO NOTHING			TRANSITION SENSITIVE - CHANGE FROM MAN TO AUTO	
%R3306	O.Data[105]	0	GATEWAY SCAN MANUAL	1= CHANGE TO SCAN MANUAL // 0 = DO NOTHING			TRANSITION SENSITIVE - CHANGE FROM AUTO TO MAN	
%R3307	O.Data[106]	0	SCAN GATEWAY NUMBER	SET 1 TO 40			CHANGE TO MANUAL FIRST TO READ THE SETTLED GATEWAY	
%R3308	O.Data[107]	0	TIME STAMP EVENT	SET 1 TO 50			CHANGE TO MANUAL FIRST TO READ THE SETTLED GATEWAY	
%R3309	O.Data[108]	0	RESET DIFFERENTIAL WARM	1= RESET DIFFERENTIAL // 0 = DO NOTHING			RESET DIFFERENTIAL WITH A NEW WARM PERIOD	CAUTION
%R3310	O.Data[109]	0	RESET DIFFERENTIAL NO WARM	1= RESET DIFFERENTIAL // 0 = DO NOTHING			RESET DIFFERENTIAL WITHOUT A NEW WARM PERIOD	CAUTION
%R3311	O.Data[110]	0	FORCE GATEWAY OUTPUT 1	1= FORCE // 0 = DO NOTHING			CHANGE TO MANUAL FIRST AND SET THE GATEWAY TO BE FORCED	AVOID IF POSSIBLE
%R3312	O.Data[111]	0	FORCE GATEWAY OUTPUT 2	1= FORCE // 0 = DO NOTHING			CHANGE TO MANUAL FIRST AND SET THE GATEWAY TO BE FORCED	AVOID IF POSSIBLE
%R3313	O.Data[112]	0	FORCE GATEWAY TRIP RELAY	1= FORCE // 0 = DO NOTHING			CHANGE TO MANUAL FIRST AND SET THE GATEWAY TO BE FORCED	AVOID IF POSSIBLE
%R3314	O.Data[113]	0	FORCE GATEWAY TRIP THYRISTOR	1= FORCE // 0 = DO NOTHING			CHANGE TO MANUAL FIRST AND SET THE GATEWAY TO BE FORCED	AVOID IF POSSIBLE
%R3315		0	RESERVED					
%R3316		0	RESERVED					
%R3317		0	RESERVED					
%R3318		0	RESERVED					
%R3319		0	RESERVED					
%R3320		0	RESERVED					
%R3321		0	RESERVED					
%R3322		0	RESERVED					
%R3323		0	RESERVED					
%R3324		0	RESERVED					
%R3325		0	RESERVED					
%R3326	O.Data[114]	0	PAGE TO WRITE	NOTE USED IS THIS VERSION				
%R3327	O.Data[115]	0	PAGE TO READ	SET PAGE FROM 0 TO 15 TO BE READ FROM RELAY			0 = DO NOTHING // 1 TO 15 SET PAGE TO BE READ	
%R3328	O.Data[116]	0	WRITING DATA VALID	1= DATA TO BE WRITE = VALID // 0 = DO NOTHING			NOTE USED IN THIS VERSION	

# MODBUS OVER ETHERNET TCP IP SERVER

## GENERAL SPECIFICATIONS (PART 2 / 4)

PRODUCED	READ PAGE	FUNCTION	DATA	NOTE	WARNING
%R2927	0 - 16	PAGE READED	0 - 16		
%R2928	0 - 16	DATA READED VALID	1 = DATA VALID // 0 = WAIT NEW DATA	0 = READED NONE // CORRESPONDENT 1 TO 15 DATA WILL BE READED CONSIDER THE DATA READED ONLY IF %R2928 = 1	
%R2801 - %R2900	1 TO 16	DATA PAGES	SEE BELOW		
%R2801 - %R2900	1	TARGET TEMPERATURES 1 TO 100	x 10 - AS READED (FORMAT XXX.X)	THE DATA NEED TO BE DIVIDED BY 10 TO INSERT THE COMA	
%R2801 - %R2900	2	AIR TEMPERATURES 1 TO 100	x 10 - AS READED (FORMAT XXX.X)	THE DATA NEED TO BE DIVIDED BY 10 TO INSERT THE COMA	
%R2801 - %R2900	3	TARGET ALARM LEVELS 1 TO 100	x 10 - AS READED (FORMAT XXX.X)	THE DATA NEED TO BE DIVIDED BY 10 TO INSERT THE COMA	
%R2801 - %R2900	4	TARGET TRIP LEVELS 1 TO 10	x 10 - AS READED (FORMAT XXX.X)	THE DATA NEED TO BE DIVIDED BY 10 TO INSERT THE COMA	
%R2901	3	AIR ALARM LEVELS TO ALL SENSORS	x 10 - AS READED (FORMAT XXX.X)	THE DATA NEED TO BE DIVIDED BY 10 TO INSERT THE COMA	
%R2901	4	AIR TRIP LEVELS TO ALL SENSORS	x 10 - AS READED (FORMAT XXX.X)	THE DATA NEED TO BE DIVIDED BY 10 TO INSERT THE COMA	
%R2801 - %R2900	5	THM SENSORS VOLTAGE	X100 - AS READED (FORMAT XX.XX)	THE DATA NEED TO BE DIVIDED BY 100 TO INSERT THE COMA	
%R2801 - %R2900	6	ARC SENSORS VOLTAGE	X100 - AS READED (FORMAT XX.XX)	CHANGE TO MANUAL AND SET THE GATEWAY FIRST AT %R3307	
%R2801 - %R2900	7	TARGET ALARM ACTIVE 1 TO 100	2 = ACTIVE // 0 = INACTIVE		
%R2801 - %R2900	8	TARGET TRIP ACTIVE 1 TO 100	2 = ACTIVE // 0 = INACTIVE		
%R2801 - %R2900	9	AIR ALARM ACTIVE 1 TO 100	2 = ACTIVE // 0 = INACTIVE		
%R2801 - %R2900	10	AIR TRIP ACTIVE 1 TO 100	2 = ACTIVE // 0 = INACTIVE		
%R2801 - %R2900	11	THM SENSORS STATUS	0 = RESPONDING // 1 = NOT RESPONDING		
%R2801 - %R2900	12	ARC SENSORS STATUS	0 = RESPONDING // 1 = NOT RESPONDING	CHANGE TO MANUAL AND SET THE GATEWAY FIRST	
%R2801 - %R2900	13	GATEWAYS STATUS	0 = RESPONDING // 1 = NOT RESPONDING	SEE ALL GATEWAYS RESPONDING OR NOT (1 TO 40)	
%R2801 - %R2900	14	ARC SEQUENCE	AS READED - SAME AS THE DISPLAY	CHANGE TO MANUAL AND SET THE GATEWAY FIRST AT %R3307	
%R2801	15	THM COMM OK	0 = NOT OK // 1 = OK		
%R2802	15	THM COMM NOT OK	0 = OK // 1 = NOT OK		
%R2803	15	ARC COMM OK	0 = NOT OK // 1 = OK		
%R2804	15	ARC COMM NOT OK	0 = OK // 1 = NOT OK		
%R2805	15	GATEWAY PGMD	0 = NO // 1 = PROGRAMMED		
%R2806	15	GATEWAY READY	0 = NO // 1 = READY	CHANGE TO MANUAL AND SET THE GATEWAY FIRST AT %R3307	
%R2807	15	GATEWAY ALRME	0 = NO // 1 = ALARMED	CHANGE TO MANUAL AND SET THE GATEWAY FIRST AT %R3307	
%R2808	15	GATEWAY TRIP	0 = NO // 1 = TRIPPED	CHANGE TO MANUAL AND SET THE GATEWAY FIRST AT %R3307	
%R2809	15	GATEWAY CHAIN INPUT	0 = NO // 1 = CHAIN ACTIVE	CHANGE TO MANUAL AND SET THE GATEWAY FIRST AT %R3307	
%R2810	15	INHIBITED	0 = NO // 1 = INHIBITED		
%R2811	15	LINK STATE	0 = ETHERNET NOT LINKED // 1 = LINKED		
%R2812	15	RESERVED			
%R2813	15	ANY FAIL ACTIVE	0 = NO // FAIL ACTIVE		
%R2814	15	TARGET FAIL	0 = NO // FAIL ACTIVE		
%R2815	15	AIR FAIL	0 = NO // FAIL ACTIVE		
%R2816	15	ALARM ACTIVE	0 = NO // ALARM ACTIVE		
%R2817	15	TRIP ACTIVE	0 = NO // TRIP ACTIVE		
%R2818	15	ALARM UNACKNOWLEDGED	0 = NO // 1 = YES		
%R2819	15	ALARM UNCLEARD	0 = NO // 1 = YES		
%R2820	15	TARGET ALARM ACTIVE	0 = NO // 1 = YES		
%R2821	15	TARGET TRIP ACTIVE	0 = NO // 1 = YES		
%R2822	15	AIR ALARM ACTIVE	0 = NO // 1 = YES		
%R2823	15	AIR TRIP ACTIVE	0 = NO // 1 = YES		

# MODBUS OVER ETHERNET TCP IP SERVER

## GENERAL SPECIFICATIONS (PART 3 / 4)

PRODUCED	READ PAGE	FUNCTION	DATA	NOTE	WARNING
%R2824	15	THM SENSOR FAIL ACTIVE	0 = NO // 1 = YES		
%R2825	15	EXTERNAL FAIL 1 ACTIVE	0 = NO // 1 = YES		
%R2826	15	EXTERNAL FAIL 2 ACTIVE	0 = NO // 1 = YES		
%R2827	15	ANALOG 1 ALARM ACTIVE	0 = NO // 1 = YES		
%R2828	15	ANALOG 2 ALARM ACTIVE	0 = NO // 1 = YES		
%R2829	15	ANALOG 3 ALARM ACTIVE	0 = NO // 1 = YES		
%R2830	15	ANALOG 4 ALARM ACTIVE	0 = NO // 1 = YES		
%R2831	15	ANALOG 1 TRIP ACTIVE	0 = NO // 1 = YES		
%R2832	15	ANALOG 2 TRIP ACTIVE	0 = NO // 1 = YES		
%R2833	15	ANALOG 3 TRIP ACTIVE	0 = NO // 1 = YES		
%R2834	15	ANALOG 4 TRIP ACTIVE	0 = NO // 1 = YES		
%R2835	15	EXCESS LIFE ACTIVE	0 = NO // 1 = YES		
%R2836	15	DIFFERENTIAL ALARM ACTIVE	0 = NO // 1 = YES		
%R2837	15	DIFFERENTIAL TRIP ACTIVE	0 = NO // 1 = YES		
%R2838	15	REMOTE 1 ACTIVE	0 = NO // 1 = YES		
%R2839	15	REMOTE 2 ACTIVE	0 = NO // 1 = YES		
%R2840	15	G1 TARGT ALARM ACTIVE	0 = NO // 1 = YES		
%R2841	15	G2 TARGT ALARM ACTIVE	0 = NO // 1 = YES		
%R2842	15	G3 TARGT ALARM ACTIVE	0 = NO // 1 = YES		
%R2843	15	G4 TARGT ALARM ACTIVE	0 = NO // 1 = YES		
%R2844	15	G5 TARGT ALARM ACTIVE	0 = NO // 1 = YES		
%R2845	15	G1 AIR ALARM ACTIVE	0 = NO // 1 = YES		
%R2846	15	G2 AIR ALARM ACTIVE	0 = NO // 1 = YES		
%R2847	15	G3 AIR ALARM ACTIVE	0 = NO // 1 = YES		
%R2848	15	G4 AIR ALARM ACTIVE	0 = NO // 1 = YES		
%R2849	15	G5 AIR ALARM ACTIVE	0 = NO // 1 = YES		
%R2850	15	G1 TARGT TRIP ACTIVE	0 = NO // 1 = YES		
%R2851	15	G2 TARGT TRIP ACTIVE	0 = NO // 1 = YES		
%R2852	15	G3 TARGT TRIP ACTIVE	0 = NO // 1 = YES		
%R2853	15	G4 TARGT TRIP ACTIVE	0 = NO // 1 = YES		
%R2854	15	G5 TARGT TRIP ACTIVE	0 = NO // 1 = YES		
%R2855	15	G1 AIR TRIP ACTIVE	0 = NO // 1 = YES		
%R2856	15	G2 AIR TRIP ACTIVE	0 = NO // 1 = YES		
%R2857	15	G3 AIR TRIP ACTIVE	0 = NO // 1 = YES		
%R2858	15	G4 AIR TRIP ACTIVE	0 = NO // 1 = YES		
%R2859	15	G5 AIR TRIP ACTIVE	0 = NO // 1 = YES		
%R2860	15	GATEWAY NOT PROGRAMMED	0 = NO // 1 = YES		
%R2861	15	ANY ARC GATEWAY COMM FAIL	0 = NO // 1 = YES		
%R2862	15	ARC SENSOR NOT RESPONDIG FAIL	0 = NO // 1 = YES		
%R2863	15	ARC FLASH ALARM ACTIVE	0 = NO // 1 = YES		
%R2864	15	ARC FLASH TRIP ACTIVE	0 = NO // 1 = YES		
%R2865	15	ARC CHAIM ACTIVE (TRIP)	0 = NO // 1 = YES		

# MODBUS OVER ETHERNET TCP IP SERVER

## GENERAL SPECIFICATIONS (PART 4 / 4)

PRODUCED	READ PAGE	FUNCTION	DATA	NOTE	WARNING
%R2866	15	SCREEN ALARM UNCLEARED	0 = NO // 1 = YES		
%R2867	15	SCREEN ALARM UNACKNOWLEDGED	0 = NO // 1 = YES		
%R2868	15	SCREEN ALARM ANY FAIL ACTIVE	0 = NO // 1 = YES		
%R2869	15	SCANNING GATEWAY AUTO	0 = NO // 1 = YES		
%R2870	15	SCANNING GATEWAY MANUAL	0 = NO // 1 = YES		
%R2801	16	MAX TARGET TEMPERATURE	x 10 - AS READED (FORMAT XXX.X)	THE DATA NEED TO BE DIVIDED BY 10 TO INSERT THE COMA	
%R2802	16	MAX AIR TEMPERATURE	x 10 - AS READED (FORMAT XXX.X)	THE DATA NEED TO BE DIVIDED BY 10 TO INSERT THE COMA	
%R2803	16	MEMORY CARD STATUS	0=OK// 1= UNKNOWN FORMAT// 2=NO CARD//	3= NOT SUPPORTED//4=ILEGAL SWAP//5=UNKNOWN//PROTECTED	
%R2804	16	DIFFERENTIAL TIME TO WARM HOUR	AS READED		
%R2805	16	DIFFERENTIAL TIME TO WARM MINUTE	AS READED		
%R2806	16	DIFFERENTIAL TIME TO RESTART HOUR	AS READED		
%R2807	16	DIFFERENTIAL TIME TO RSTRT MINUTE	AS READED		
%R2808	16	DIFFERENTIAL ON	0 = NO // 1 = YES		
%R2809	16	DIFFERENTIAL WARM OK	0 = NO // 1 = YES		
%R2810	16	DIFFERENTIAL FIRST READ OK	0 = NO // 1 = YES		
%R2811	16	DIFFERENTIAL VALID (OPERATING)	0 = NO // 1 = YES		
%R2812	16	REDING THM SENSOR NUMBER	AS READED (1 TO 100)		
%R2813	16	SCANNING GATEWAY NUMBER	AS READED (1 TO 40)		
%R2814	16	REDING ARC SENSOR NUMBER	AS READED (1 TO 100)		
%R2815	16	TOTAL THM SENSOR RESPONDING	0 TO 100		
%R2816	16	TOTAL THM SENSOR NOT RESPONDING	0 TO 100		
%R2817	16	TOTAL ALRM ACTIVE			
%R2818	16	TOTAL TRIP ACTIVE			
%R2819	16	TOTAL ARC SENSOR RESPONDING			
%R2820	16	TOTAL ARC SENSOR NOT RESPONDING			
%R2821	16	TOTAL ARC FLASH NOT CLEARED			
%R2822	16	TIME TO RETURN TO SCAN AUTO	AS READED (600 TO 0 s)		
%R2823	16	REAL TIME CLOCK DAY	1 TO 31		
%R2824	16	REAL TIME CLOCK MONTH	1 TO 12		
%R2825	16	REAL TIME CLOCK YEAR			
%R2826	16	REAL TIME CLOCK HOUR	0 TO 24		
%R2827	16	REAL TIME CLOCK MINUTE	0 TO 60		
%R2828	16	REAL TIME CLOCK SECONDS	0 TO 60		
%R2829	16	STOPPED SCANNING ON GATEWAY	1 TO 40		

CHANGE TO MANUAL AND SET THE GATEWAY FIRST AT %R3307

CHANGE TO MANUAL AND SET THE GATEWAY FIRST AT %R3307  
 CHANGE TO MANUAL AND SET THE GATEWAY FIRST AT %R3308  
 CHANGE TO MANUAL AND SET THE GATEWAY FIRST AT %R3308

# MODBUS OVER ETHERNET TCP IP SERVER

## ETHERNET MODULE IN STUDIO 5000/LOGIX DESIGNER - ALLEN BRADLEY

Steps to create an Ethernet module in a project in Studio 5000/Logix Designer – Allen Bradley PLCs / Zyggot Relays Connection. Let's consider that we have only 5 temperature sensors connected to the Relay.

### 1- OPEN YOUR PROJECT

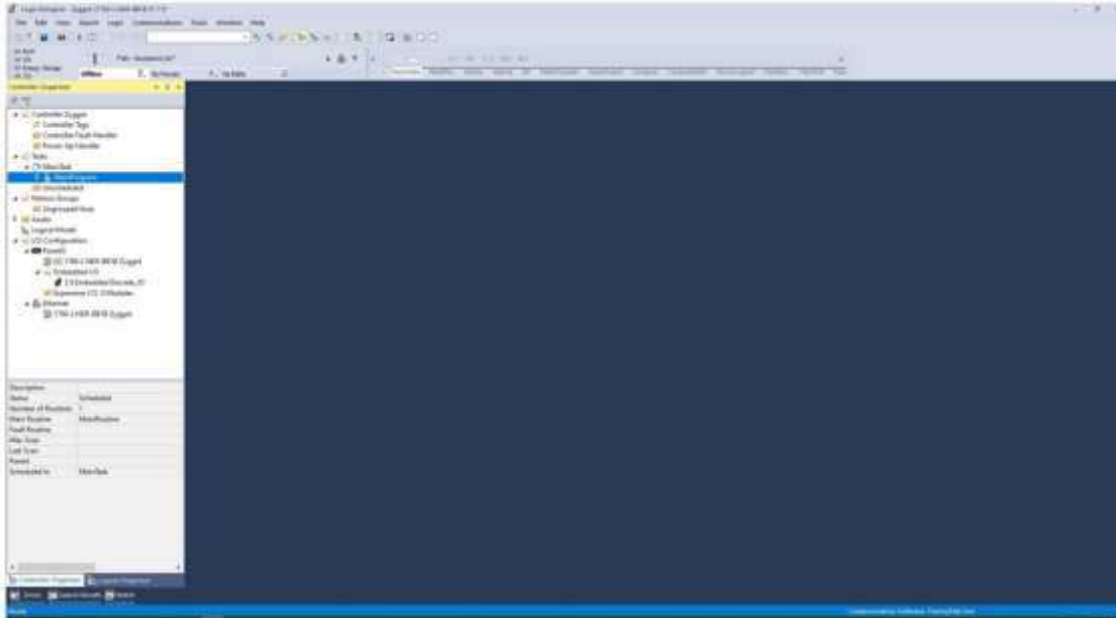

### 2- RIGHT CLICK ON "ETHERNET" AND THEN CLICK ON "NEW MODULE".



# MODBUS OVER ETHERNET TCP IP SERVER

## MÓDULO ETHERNET NO STUDIO 5000/LOGIX DESIGNER ALLEN BRADLEY

Steps to create an Ethernet module in a project in Studio 5000/Logix Designer – Allen Bradley PLCs / Zyggot Relays Connection. Let's consider that we have only 5 temperature sensors connected to the Relay.

3- IN THE “SELECT MODULE TYPE” WINDOW, SELECT THE “CATALOG” TAB AND TYPE “GENERIC” IN THE SEARCH FIELD.

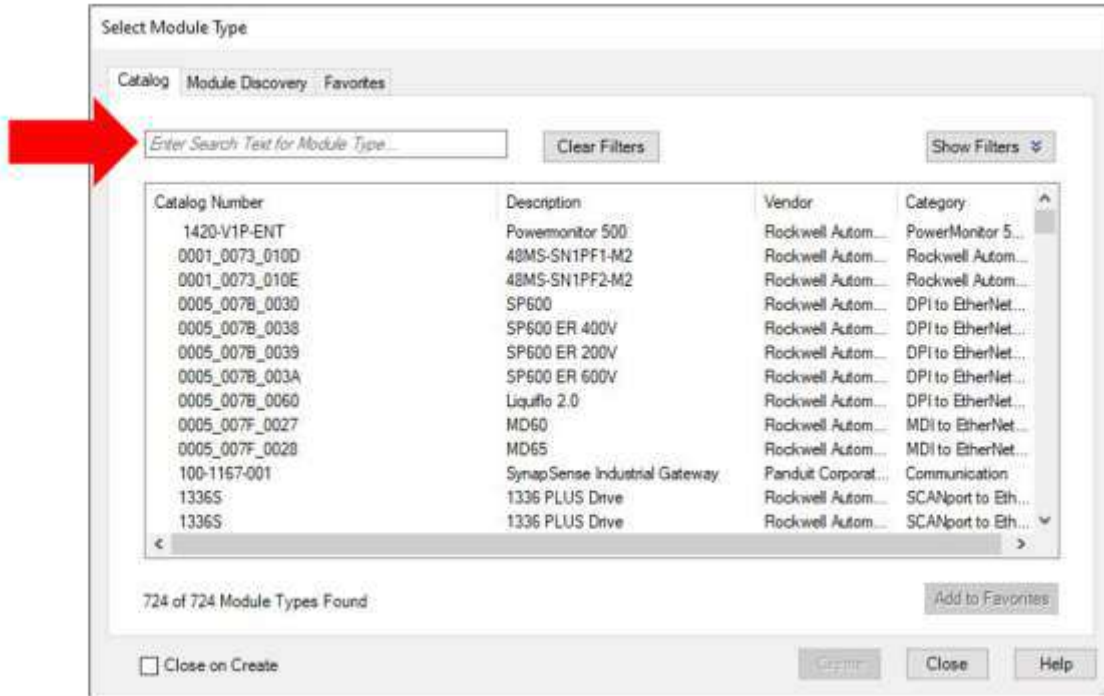

4- THEN SELECT “ETHERNET-MODULE” AND CLICK “CREATE”.

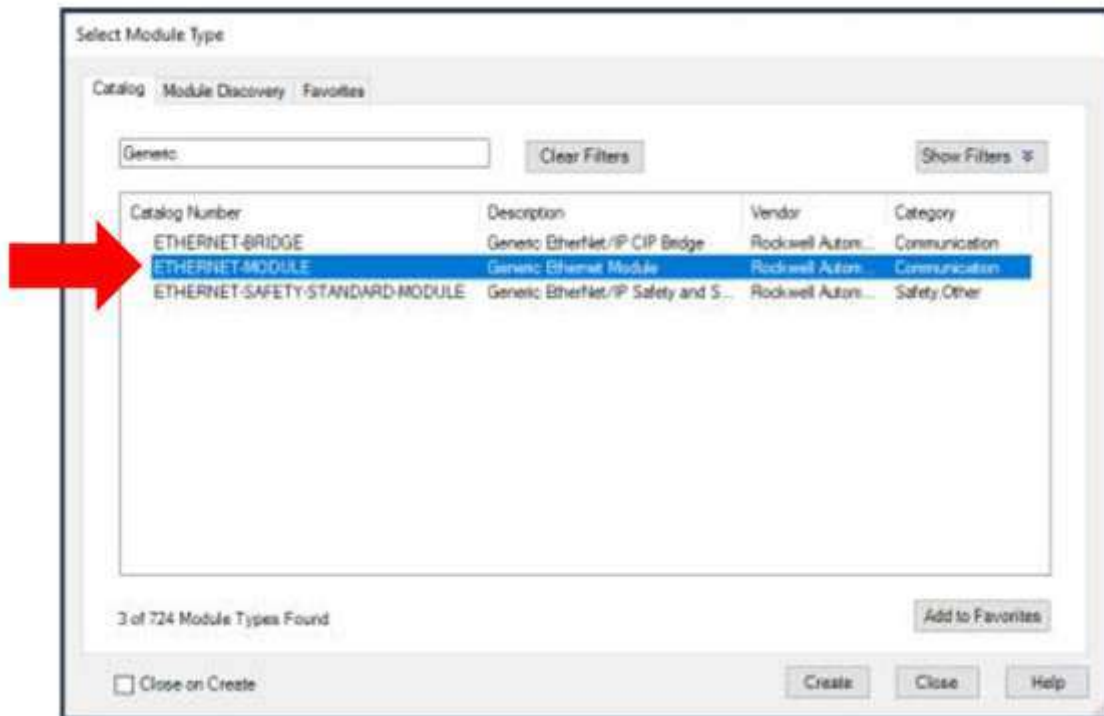

## MODBUS OVER ETHERNET TCP IP SERVER

### MÓDULO ETHERNET NO STUDIO 5000/LOGIX DESIGNER ALLEN BRADLEY

Steps to create an Ethernet module in a project in Studio 5000/Logix Designer – Allen Bradley PLCs / Zyggot Relays Connection. Let's consider that we have only 5 temperature sensors connected to the Relay.

#### 5- IN THE “NEW MODULE” WINDOW:

- IN THE “COMM FORMAT” FIELD, CHOOSE THE “DATA – INT” OPTION
  - IN “IP ADDRESS”, ENTER THE IP THAT WAS CONFIGURED IN THE ZYGGOT FTA VARIXX RELAY
  - IN “ASSEMBLY INSTANCE” INPUT, ENTER “100”
  - IN “SIZE” INPUT, ENTER “128”
  - IN “ASSEMBLY INSTANCE” OUTPUT, ENTER “101”
  - IN “SIZE” OUTPUT, ENTER “128”
  - IN “ASSEMBLY INSTANCE” CONFIGURATION, ENTER “3”
  - IN “SIZE” CONFIGURATION, ENTER “0”
- THEN CLICK “OK”.

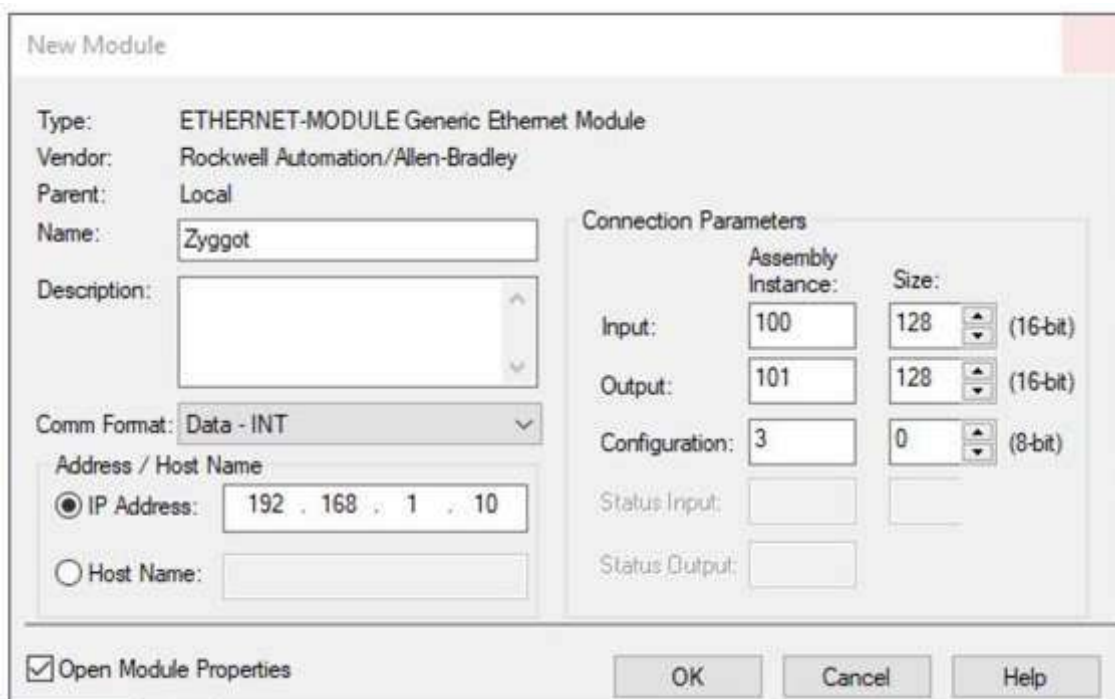

# MODBUS OVER ETHERNET TCP IP SERVER

## MÓDULO ETHERNET NO STUDIO 5000/LOGIX DESIGNER ALLEN BRADLEY

Steps to create an Ethernet module in a project in Studio 5000/Logix Designer – Allen Bradley PLCs / Zyggot Relays Connection. Let's consider that we have only 5 temperature sensors connected to the Relay.

### 6- DOWNLOAD THE PROJECT TO THE PLC.

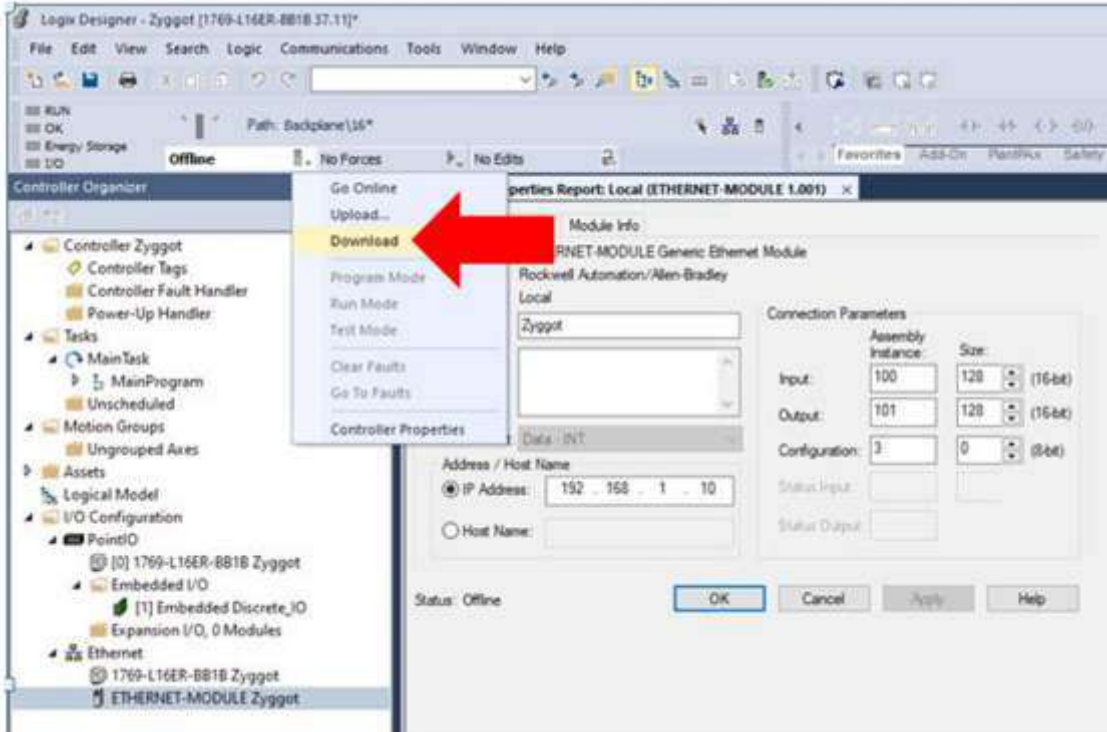

### 7- TESTING: READING THE TARGET TEMPERATURE OF THE 5 SENSORS CONNECTED TO THE RELAY.

7a- LEAVE THE PLC IN RUN MODE BY THE SYSTEM AND DOUBLE CLICK ON “CONTROLLER TAGS”.

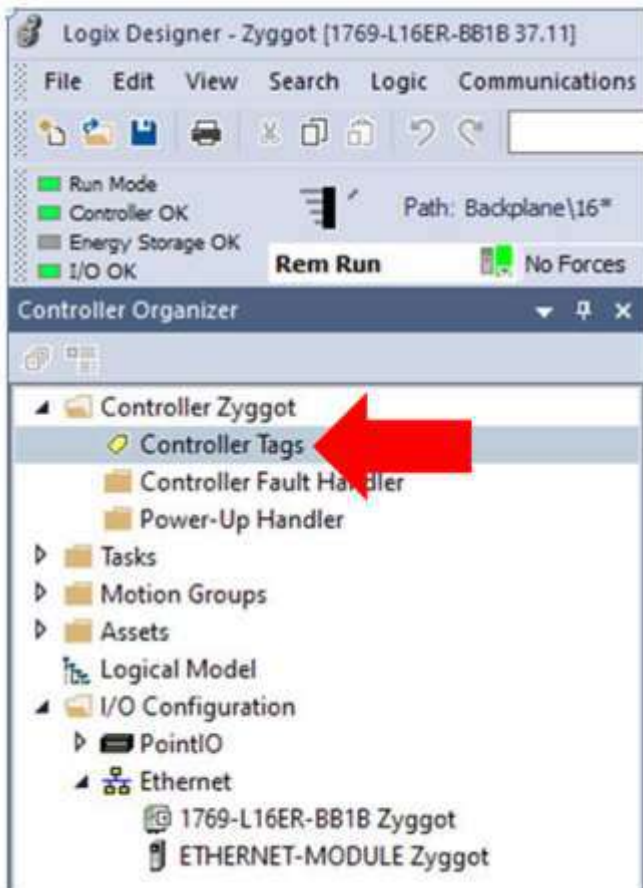

# MODBUS OVER ETHERNET TCP IP SERVER

## MÓDULO ETHERNET NO STUDIO 5000/LOGIX DESIGNER ALLEN BRADLEY

Steps to create an Ethernet module in a project in Studio 5000/Logix Designer – Allen Bradley PLCs / Zyggot Relays Connection. Let's consider that we have only 5 temperature sensors connected to the Relay.

7b- SELECT AS SHOWN.

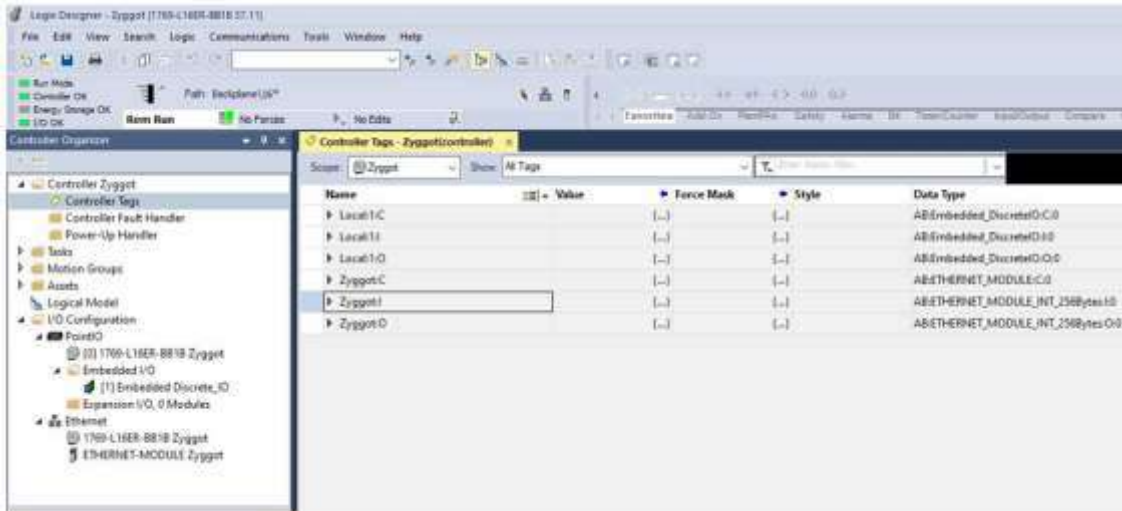

7c- FIND THE OUTPUT RECORD "...0.DATA[126]" (%R3327) AND MAKE SURE IT HAS THE VALUE "1," OTHERWISE, ASSIGN IT THE VALUE "1" (THIS WILL SELECTE PAGE 1, THIS «PAGE» IS REFERENT TO THE SYSTEM TARGET TEMPERATURE VALUES).

Zyggot:O.Data[120]	0	Decimal	INT
Zyggot:O.Data[121]	0	Decimal	INT
Zyggot:O.Data[122]	0	Decimal	INT
Zyggot:O.Data[123]	0	Decimal	INT
Zyggot:O.Data[124]	0	Decimal	INT
Zyggot:O.Data[125]	0	Decimal	INT
Zyggot:O.Data[126]	1	Decimal	INT
Zyggot:O.Data[127]	0	Decimal	INT

7d - NOW FIND THE INPUT REGISTER "...I.DATA[0]" (%R2801), DIVIDING THE VALUE RECEIVED BY 10, WE WILL HAVE THE TARGET TEMPERATURE OF SENSOR 1. IN THE REGISTER "...I.DATA[1]" (%R2802) WE HAVE THE TARGET TEMPERATURE OF SENSOR 2 AND SO ON. IN THE IMAGE BELOW WE HAVE THE TEMPERATURE VALUES OF THE FIRST 5 SENSORS READ BY THE RELAY (NOT YET DIVIDED BY 10).

Name	Value	Force Mask	Style	Data Type
LocalI:C	[...]	[...]	[...]	AB:Embedded_DiscretelO:C:0
LocalI:I	[...]	[...]	[...]	AB:Embedded_DiscretelO:I:0
LocalI:O	[...]	[...]	[...]	AB:Embedded_DiscretelO:O:0
Zyggot:C	[...]	[...]	[...]	AB:ETHERNET_MODULE:C:0
ZyggotI	[...]	[...]	[...]	AB:ETHERNET_MODULE_INT_256Bytes:I:0
ZyggotI.Data	[...]	[...]	Decimal	INT[128]
ZyggotI.Data[0]	233		Decimal	INT
ZyggotI.Data[1]	232		Decimal	INT
ZyggotI.Data[2]	224		Decimal	INT
ZyggotI.Data[3]	211		Decimal	INT
ZyggotI.Data[4]	245		Decimal	INT
ZyggotI.Data[5]			Decimal	INT
ZyggotI.Data[6]	0		Decimal	INT
ZyggotI.Data[7]	0		Decimal	INT
ZyggotI.Data[8]	0		Decimal	INT
ZyggotI.Data[9]	0		Decimal	INT

# BT SENSOR TEST REPORT

CAN BE EXTENDED TO THE TUBULAR SENSOR BY SIMILARITY

## Zyggot BT Sensor Analysis Report

Date: 10/04/2022

### Objetive

Check the reliability of temperature measurements using the Zyggot BT sensor

### Used equipments

Equipment	Fabricante	Modelo	Número de Série
4 CH 100MHz Oscilloscope	Keysight	DSOX 3014T	MY55120213
Infrared Thermometer Calibrator	Fluke	9133	CO6729
DC Power Supply 24V 60W	Varixx	VPS6024	VFE22132
Zyggot Relay Model V5L/V5F	Varixx	VZX/B1/U	SRT1003315
125 Zyggot Temperature Sensor Model V5L/V5F	Varixx	ZSB/M/60/120	SBT1037459 ao SBT1037584

### Temperature ramp response curve

Measurement performed using a Zyggot BT sensor pointed at the target ranging from 0 to 120°C

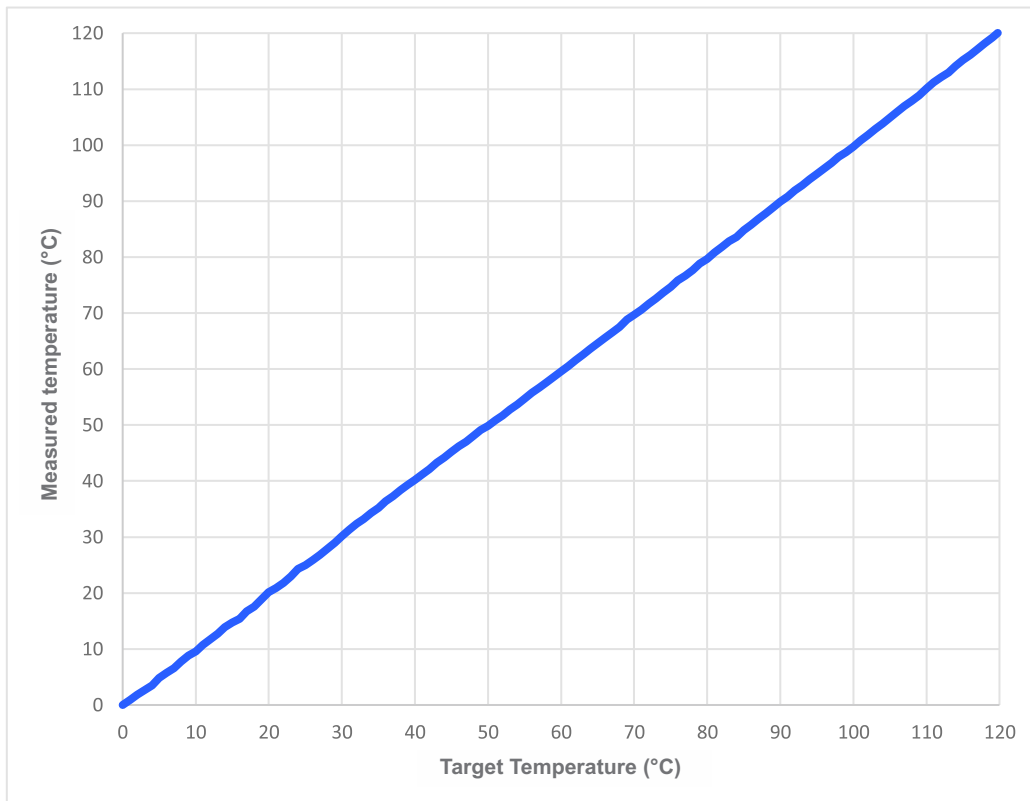

Maximum absolute error: 0.6°C  
Standard Deviation: 0.23°C

## Measurement distribution of 125 sensors targeting at 80°C

Measurement carried out with 125 sensors connected in a network in the Zyggot relay and with a fixed target at 80°C

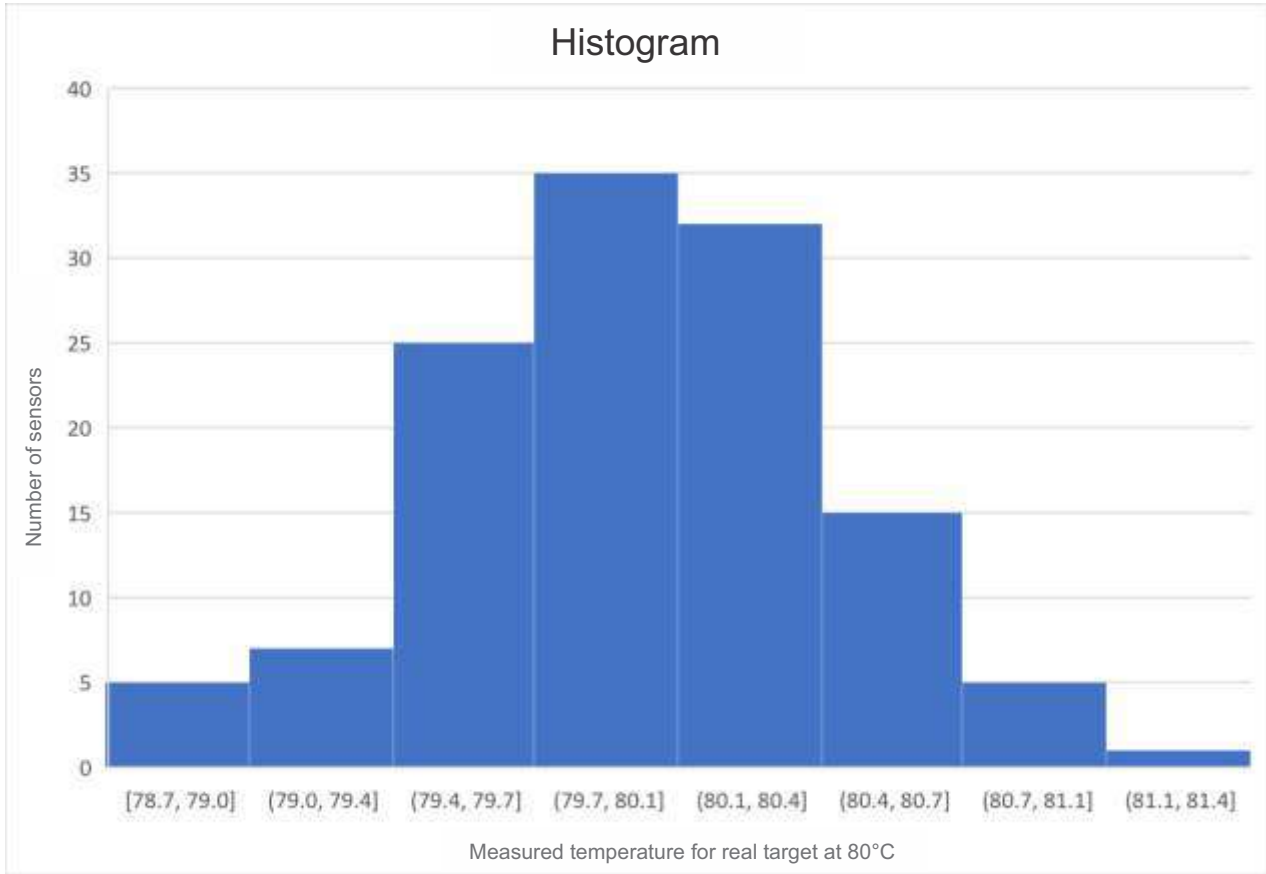

Maximum absolute error: 1.3°C

Standard Deviation: 0.48°C

## ABOUT VARIXX

For over 40 years, Varixx has pursued its vocation for developing high-tech products and focuses its efforts on serving the industrial market with quality and speed. Our know-how in power electronics has allowed us to offer the market a wide range of products that have become known for their long service life and reliability. We were the creators of the global online thermography market, with the Zyggot line, which is becoming a global reference in the market for temperature monitoring and diagnostics and arc flash detection in electrical systems in general.

Our product portfolio also includes LED luminaires from our ONNO division, developed and manufactured 100% in Brazil with cutting-edge technology. Varixx values the introduction of innovative concepts worldwide.

## AREAS OF ACTIVITY

- ✓ **MANUFACTURERS OF GENERATOR MACHINES AND SYNCHRONOUS MOTORS**  
Static Exciters, Control Box Controllers, Low and Medium Voltage Soft Starters, Semiconductors
- ✓ **PRODUCTION OF ALUMINUM AND HYDROGEN / OXYGEN**  
High Current Rectifiers, Solid State Contactors, Smart Relay for CCM, Online Thermography System and Arc Flash Detection and Onno LED Luminaires.
- ✓ **BASE INDUSTRY, MINING AND STEEL INDUSTRY**  
Smart Relays for CCMs, Low and Medium Voltage Soft Starters, Solid State Contactors, AC/DC Converters for electromagnets, High Current Rectifiers, Online Thermography System, Arc Flash Detection and Protection and Onno LED Luminaires.
- ✓ **OIL COMPANIES**  
Smart Relays for CCMs, Static Excitation, Low and Medium Voltage Soft Starters, Solid State Contactors, Online Thermography System, Arc Flash Detection and Protection and Onno LED Luminaires.
- ✓ **ELECTRIC PANEL ASSEMBLERS**  
Smart Relays for CCMs, Online Thermography, Arc Flash Detection and Protection System, Semiconductors, Power Supplies and Onno LED Luminaires.

### Why ZYGGOT Thermography And Arc Flash Protection?



**SINGLE CABLE / EASY TO INSTALL**



**PREDICTIVE / DIFFERENTIAL PROTECTION**



**EFFECTIVE PROTECTION AGAINST ARC DESTRUCTION**



**WORLDWIDE UNIQUE BY UV DETECTION / NO CURRENT READINGS REQUIRED**



**DOES NOT NEED CONVENTIONAL THERMOGRAPHY / ALSO MEASURES AIR TEMP.**



**WITHOUT CONTACT / WITH NETWORK COMMUNICATION**

## LEARN MORE!

### ZYGGOT ARC FLASH SYSTEM

- ✓ **Low Cost // Up to 100 sensors per gateway.**
- ✓ **Innovative in the market // Faster (<300 uS versus up to 500 mS)**
- ✓ **Ultraviolet arc detection**
- ✓ **Does not operate with ambient light (False Alarm)**
- ✓ **No need for current readings**

# varixx

ALWAYS INNOVATING

www.varixx.com.br  
vendas@varixx.com.br  
+55 (19) 3424-4000  
+55 (19) 3301-6900

R. Felipe Zaidan Maluf, 450  
Distrito Industrial Unileste  
Piracicaba-SP. CEP: 13422-190



@Varixxbrasil



@varixxcompany



Varixx Indústria Eletrônica



www.varixx.com  
www.varixx.com.br

Representative/Distributor:

## VARIXX USA

2229 Allen Parkway, Suite 200  
+1 832-871-5700  
Houston - Texas, 77019

## VARIXX WORLDWIDE

MORE THAN 20 BRANCHES,  
DISTRIBUTORS AND REPRESENTATIVE  
OFFICES WORLDWIDE



ZYGGOT THERMOGRAPHY